

Clemson University

**TigerPrints**

---

All Dissertations

Dissertations

---

12-2022

## Cohen-Macaulay Type of Weighted Path Ideals

Shuai Wei

*Clemson University*, [wei6@clemson.edu](mailto:wei6@clemson.edu)

Follow this and additional works at: [https://tigerprints.clemson.edu/all\\_dissertations](https://tigerprints.clemson.edu/all_dissertations)



Part of the [Algebra Commons](#)

---

### Recommended Citation

Wei, Shuai, "Cohen-Macaulay Type of Weighted Path Ideals" (2022). *All Dissertations*. 3248.  
[https://tigerprints.clemson.edu/all\\_dissertations/3248](https://tigerprints.clemson.edu/all_dissertations/3248)

This Dissertation is brought to you for free and open access by the Dissertations at TigerPrints. It has been accepted for inclusion in All Dissertations by an authorized administrator of TigerPrints. For more information, please contact [kokeefe@clemson.edu](mailto:kokeefe@clemson.edu).

# COHEN-MACAULAY TYPE OF WEIGHTED PATH IDEALS

---

A Dissertation  
Presented to  
the Graduate School of  
Clemson University

---

In Partial Fulfillment  
of the Requirements for the Degree  
Doctor of Philosophy  
Mathematical Sciences

---

by  
Shuai Wei  
December 2022

---

Accepted by:  
Dr. Keri Sather-Wagstaff, Committee Chair  
Dr. Michael Burr  
Dr. Shuhong Gao  
Dr. Matthew Macauley

# Abstract

In this dissertation we give a combinatorial characterization of all the weighted  $r$ -path suspensions for which the  $f$ -weighted  $r$ -path ideal is Cohen-Macaulay. In particular, it is shown that the  $f$ -weighted  $r$ -path ideal of a weighted  $r$ -path suspension is Cohen-Macaulay if and only if it is unmixed. Type is an important invariant of a Cohen-Macaulay homogeneous ideal in a polynomial ring  $R$  with coefficients in a field. We compute the type of  $R/I$  when  $I$  is any Cohen-Macaulay  $f$ -weighted  $r$ -path ideal of any weighted  $r$ -path suspension, for some chosen function  $f$ . In particular, this computes the type for all weighted trees  $T_\omega$  such that the corresponding ideal is Cohen-Macaulay.

I am dedicating this dissertation to my parents Manlong Wei and Jihua Pu, with love.

# Acknowledgments

I would like to thank my supervisor, Dr. Keri Sather-Wagstaff for her wonderful guidance and tremendous engagement throughout all stages of this journey. I have been extremely lucky to have a supervisor who cared so much about her students and their work.

I must express my sincere gratitude to my committees Dr. Michael Burr, Dr. Shuhong Gao, and Dr. Matthew Macauley for their invaluable patience and feedback.

I am deeply grateful to my fellow students, Michael Cowen, Hugh Geller, and Todd Morra for being my collaborators to discuss the assignment questions and sharing their resources.

I am also really thankful to my classmates and friends for their help and to all those who contributed directly or indirectly towards the completion of this project. I would like to extend my special thanks to my friend Daozhou Zhu for sharing his thoughts and experience in studying pure mathematics.

Finally, I would like to acknowledge my family for their unwavering financial and moral support. They have allowed me to pursue my passion in mathematics. Special thanks to my wife Yahui Zhang for her love and consistent support and my son Corey Wei for his giving my life a powerful sense of purpose.

# Contents

<b>Title Page</b> . . . . .	<b>i</b>
<b>Abstract</b> . . . . .	<b>ii</b>
<b>Dedication</b> . . . . .	<b>iii</b>
<b>Acknowledgments</b> . . . . .	<b>iv</b>
<b>1 Introduction</b> . . . . .	<b>1</b>
1.1 Graphs and Ideals . . . . .	1
1.2 Cohen-Macaulayness . . . . .	4
1.3 Cohen-Macaulay Type . . . . .	5
<b>2 Background</b> . . . . .	<b>6</b>
2.1 Local Rings . . . . .	6
2.2 Monomial Ideals . . . . .	8
2.3 Regular Sequences . . . . .	13
2.4 Ext via Projective Resolutions . . . . .	14
2.5 Depth, Type, and Cohen-Macaulayness . . . . .	19
2.6 Graded rings and modules . . . . .	21
2.7 Graded Cohen-Macaulay Rings . . . . .	22
<b>3 Cohen-Macaulayness of <math>f</math>-Weighted <math>r</math>-Path Ideals</b> . . . . .	<b>25</b>
3.1 Background . . . . .	25
3.2 Sufficient Conditions for Unmixedness . . . . .	34
3.3 Necessary Conditions for Unmixedness . . . . .	72
3.4 Sufficient Conditions for Cohen-Macaulayness . . . . .	105
3.5 Main Results . . . . .	107
<b>4 Cohen-Macaulay Type of Weighted <math>r</math>-Path Ideals</b> . . . . .	<b>112</b>
4.1 Background . . . . .	112
4.2 Type . . . . .	115
<b>5 Future work</b> . . . . .	<b>134</b>
5.1 Generalized Weighted Simplicial Complex . . . . .	134
5.2 More classifications . . . . .	134
<b>Bibliography</b> . . . . .	<b>137</b>

# Chapter 1

## Introduction

Combinatorial commutative algebra is a branch of mathematics that uses combinatorics and graph theory to understand algebraic constructions; it also uses algebra to understand objects in combinatorics and graph theory. Richard Stanley was the first to strongly leverage commutative algebra techniques to study combinatorial objects in his proof of the upper bound conjecture for simplicial spheres [12]. His focus was on square-free monomial ideals. Since then, the study of square-free monomial ideals has become a very active area of research in commutative algebra.

### 1.1 Graphs and Ideals

In this dissertation, we explore aspects of this area via path ideals of graphs and edge-weighted graphs.

On the graph-theoretic side, let  $G$  be a (finite simple) graph with vertex set  $V = V(G) = \{v_1, \dots, v_d\}$  and edge set  $E = E(G)$ . To the graph  $G$ , one can attach a positive integer-valued function  $\omega : E \rightarrow \mathbb{N}$ , producing an edge-weighted graph  $G_\omega$ .

On the algebraic side, let  $\mathbb{K}$  be a field, and consider the polynomial ring  $R = \mathbb{K}[X_1, \dots, X_d]$ . Villarreal [13] defined the *edge ideal* of  $G$  to be the ideal  $I(G)$  that is “generated by the edges of  $G$ ”:

$$I(G) = (X_i X_j \mid v_i v_j \in E)R.$$

By definition, the edge ideal  $I(G)$  is square-free.

**Example 1.1.1.** Let  $G$  be the following graph and  $R = \mathbb{K}[X_1, X_2, X_3, X_4, X_5]$ .

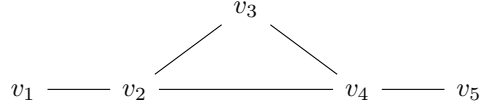

The edge ideal of  $G$  is

$$I(G) = (X_1X_2, X_2X_3, X_2X_4, X_3X_4, X_4X_5)R.$$

Paulsen and Sather-Wagstaff [10] introduced the weighted edge ideal of  $G_\omega$  to be the ideal  $I(G_\omega)$  which is generated by all monomials of the form  $X_i^{\omega(v_iv_j)}X_j^{\omega(v_iv_j)}$  such that  $v_iv_j \in E$ :

$$I(G_\omega) = \left( X_i^{\omega(v_iv_j)} X_j^{\omega(v_iv_j)} \mid v_iv_j \in E \right) R.$$

In particular, if  $\omega$  is the constant function defined by  $\omega(v_iv_j) = 1$  for  $v_iv_j \in E$ , then  $I(G_\omega) = I(G)$ .

By definition, the weighted edge ideal  $I(G_\omega)$  is usually not square-free.

**Example 1.1.2.** Let  $G_\omega$  be the following edge-weighted graph and  $R = \mathbb{K}[X_1, X_2, X_3, X_4, X_5]$ .

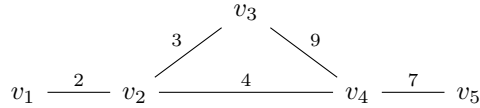

The weighted edge ideal of  $G_\omega$  is

$$I(G_\omega) = (X_1^2X_2^2, X_2^3X_3^3, X_2^4X_4^4, X_3^9X_4^9, X_4^7X_5^7)R.$$

$I(G_\omega)$  has the same number of generators as  $I(G)$ .

Let  $r \geq 1$ . Building from Villarreal's work, Conca and De Negri [3] defined the  $r$ -path ideal associated to  $G$  to be the ideal  $I_r(G) \subseteq R$  that is "generated by the paths in  $G$  of length  $r$ ":

$$I_r(G) = (X_{i_1} \cdots X_{i_{r+1}} \mid v_{i_1} \cdots v_{i_{r+1}} \text{ is a path in } G)R.$$

In particular, if  $r = 1$ , then  $I_1(G) = I(G)$ .

**Example 1.1.3.** Consider the graph  $G$  from Example 1.1.1 with  $r = 2$ . Then the 2-path ideal of



$G$  is

$$\begin{aligned} I_2(G) &= (X_1X_2X_3, X_1X_2X_4, X_2X_3X_4, X_2X_4X_3, X_3X_2X_4, X_2X_4X_5, X_3X_4X_5)R \\ &= (X_1X_2X_3, X_1X_2X_4, X_2X_3X_4, X_2X_4X_5, X_3X_4X_5)R. \end{aligned}$$

Expanding this to the edge-weighted context, Kubik and Sather-Wagstaff [7] defined the *weighted  $r$ -path ideal* of  $G_\omega$  to be the ideal  $I_r(G_\omega)$  that is “generated by the max-weighted paths in  $G$  of length  $r$ ”:

$$I_r(G_\omega) = \left( X_{i_1}^{e_{i_1}} \cdots X_{i_{r+1}}^{e_{i_{r+1}}} \left| \begin{array}{l} v_{i_1} \cdots v_{i_{r+1}} \text{ is a path in } G \text{ with } e_{i_1} = \omega(v_{i_1}v_{i_2}), \\ e_{i_j} = \max(\omega(v_{i_{j-1}}v_{i_j}), \omega(v_{i_j}, v_{i_{j+1}})) \text{ for } 1 < j \leq r \\ \text{and } e_{i_{r+1}} = \omega(v_{i_r}, v_{i_{r+1}}) \end{array} \right. \right) R.$$

In particular, if  $r = 1$ , then  $I_1(G_\omega) = I(G_\omega)$ .

**Example 1.1.4.** Consider the edge-weighted graph  $G_\omega$  from Example 1.1.2. Then the weighted 2-path ideal of  $G_\omega$  is

$$I_2(G_\omega) = (X_1^2X_2^3X_3^3, X_1^2X_2^4X_4^4, X_2^3X_3^9X_4^9, X_2^4X_4^9X_3^9, X_3^3X_2^4X_4^4, X_2^4X_4^7X_5^7, X_3^9X_4^9X_5^7)R.$$

Kubik and Sather-Wagstaff also consider a much more general situation. For reasonable functions  $f : \mathbb{N} \times \mathbb{N} \rightarrow \mathbb{N}$  they defined the  *$f$ -weighted  $r$ -path ideal* associated to  $G_\omega$  to be the ideal  $I_{r,f}(G_\omega) \subseteq R$  that is “generated by the  $f$ -weighted paths in  $G$  of length  $r$ ”:

$$I_{r,f}(G_\omega) = \left( X_{i_1}^{e_{i_1}} \cdots X_{i_{r+1}}^{e_{i_{r+1}}} \left| \begin{array}{l} v_{i_1} \cdots v_{i_{r+1}} \text{ is a path in } G \text{ with } e_{i_1} = \omega(v_{i_1}v_{i_2}), \\ e_{i_j} = f(\omega(v_{i_{j-1}}v_{i_j}), \omega(v_{i_j}, v_{i_{j+1}})) \text{ for } 1 < j \leq r \\ \text{and } e_{i_{r+1}} = \omega(v_{i_r}, v_{i_{r+1}}) \end{array} \right. \right) R.$$

So  $f$  in the definition of  $I_{r,f}(G_\omega)$  replaces the max in the definition of  $I_r(G_\omega)$ .

**Example 1.1.5.** Consider the edge-weighted graph  $G_\omega$  from Example 1.1.2. Let  $r = 3$  and let  $f : \mathbb{N}^2 \rightarrow \mathbb{N}$  be the gcd function. Then the gcd-weighted 3-path ideal of  $G_\omega$  is

$$I_{3,\text{gcd}}(G_\omega) = (X_1^2X_2X_3^3X_4^9, X_1^2X_2^2X_4X_5^7, X_3^3X_2X_4X_5^7)R.$$

In this dissertation, we investigate two important notions in commutative algebra for these ideals: the Cohen-Macaulay property and the type, discussed next. Specifically, we show how properties of  $G_\omega$  yield information about these notions.

## 1.2 Cohen-Macaulayness

An important concept in commutative algebra is the ‘‘Cohen-Macaulay’’ property; see Section 2.4 in chapter 2. The definition of Cohen-Macaulayness is somewhat technical. For now, the reader should understand that Cohen-Macaulay ideals in polynomial rings are particularly nice. If  $G$  is a tree, a theorem of Villarreal [13] characterizes when  $R/I(G)$  is Cohen-Macaulay, and a theorem of Paulsen and Sather-Wagstaff [10] characterizes when  $R/I(G_\omega)$  is Cohen-Macaulay. Theorems of Campos, et al. [2] and of Kubik and Sather-Wagstaff [7] characterize the Cohen-Macaulay property for  $R/I_r(G)$  and  $R/I_r(G_\omega)$ , respectively, again for trees. These characterizations are purely graph-theoretical. In particular, they are independent of the choice of the ground field  $\mathbb{K}$ .

Cohen-Macaulay trees can be characterized in terms of suspensions (see [10, Definition 5.4]) when the edge ideals are considered. One of our focus area is on the path ideals of weighted trees. Let  $G$  be an  $r$ -path suspension (see Definition 3.1.14). The first goal of this dissertation is to characterize when  $R/I_{r,f}(G_\omega)$  is Cohen-Macaulay: for each  $r \geq 2$ , find all combinations of  $\omega : E \rightarrow \mathbb{N}$  and  $f : \mathbb{N} \times \mathbb{N} \rightarrow \mathbb{N}$  such that  $R/I_{r,f}(G_\omega)$  is Cohen-Macaulay. Let  $\text{cond}_{r=2}^{\omega,f}$ ,  $\text{cond}_{r=3}^{\omega,f}$  and  $\text{cond}_{r \geq 4}^{\omega,f}$  be the constraints from Propositions 3.2.1, 3.2.43, and 3.2.44, respectively. The diagram of proof is as follows.

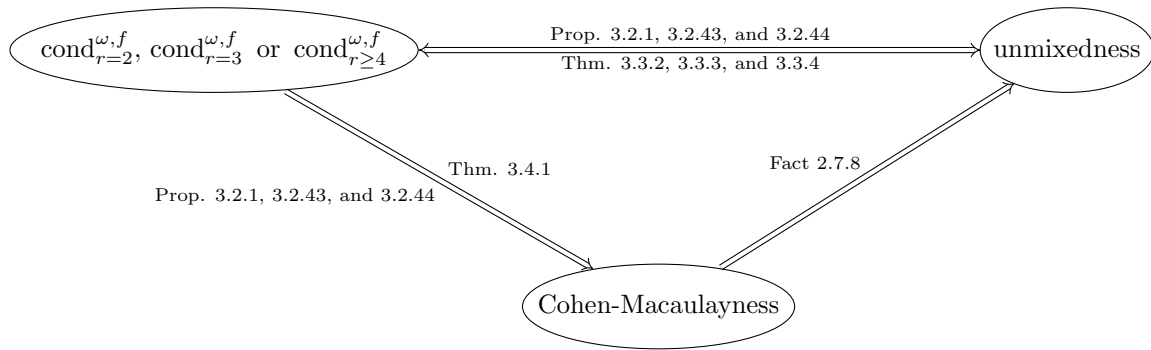

Thus, given that  $G$  is an  $r$ -path suspension,  $R/I_{r,f}(G_\omega)$  is Cohen-Macaulay if and only if  $\text{cond}_{r=2}^{\omega,f}$ ,  $\text{cond}_{r=3}^{\omega,f}$  or  $\text{cond}_{r \geq 4}^{\omega,f}$  is satisfied. Furthermore, we use this to characterize the Cohen-Macaulay

property for  $R/I_{r,f}(G_\omega)$  when  $G$  is a tree. The results are in Theorems 3.5.5 and 3.5.6.

We use similar techniques to study certain non-square-free monomial ideals as in studying square-free monomials. However, we observe that the useful polarization technique used in [7, 10] fails in studying the Cohen-Macaulayness of  $R/I_{r,f}(G_\omega)$ . We solved this by combining commutative algebraic techniques and combinatorial analysis. It is reflected in the theorems and propositions from the above proof diagram.

### 1.3 Cohen-Macaulay Type

If  $I$  is a Cohen-Macaulay ideal in  $R$ , the “type” of  $R/I$  defined by

$$r_R(R/I) = \dim_{\mathbb{K}}(\text{Ext}_R^n(\mathbb{K}, R/I))$$

roughly measures how nice the ideal is, where  $n = \text{depth}(R/I)$  (see e.g., [11]). For instance, some of the nicest Cohen-Macaulay ideals are the “Gorenstein” ideals, which end up being the Cohen-Macaulay ideals of type 1. In Chapter 4, we compute the type of  $R/I_{r,f}(G_\omega)$  when  $f = \max$  and the ring is Cohen-Macaulay. We accomplish this in Theorem 4.2.25. As with Villarreal’s results, this computation is purely graph-theoretical. As a sample, we state the special case  $r = 1$  of the result.

**Theorem 1.3.1.** *Let  $G = \Sigma H$  be a suspension of  $H$  (see Definition 3.1.12) and  $\omega : E(G) \rightarrow \mathbb{N}$  such that  $\omega(v_i v_j) \leq \omega(v_i w_i)$  and  $\omega(v_i v_j) \leq \omega(w_j v_j)$  for each  $v_i v_j \in E(H)$ . Then the Cohen-Macaulay type of  $R/I(G_\omega)$  is*

$$r_R(R/I(G_\omega)) = \#\{\text{minimal weighted vertex covers of } H_{\omega'}\}, \text{ where } \omega' = \omega|_{E(H)},$$

where the definition for “minimal weighted vertex covers” can be found in [10, Definitions 1.4 and 1.9], or it can be regarded a special case of Definitions 3.1.3 and 3.1.5.

The classification of Cohen-Macaulay path ideals and type computing are the main results of this dissertation. They form the bulk of Chapter 3 and 4. Necessary background information is collected in Chapter 2 and Section 3.1. See also p.102 and p.105.

# Chapter 2

## Background

This chapter covers the necessary algebraic details for understanding the definitions, theorems, and techniques used in the subsequent chapters. Section 2.1 begins with the definition of local rings and then treats localizations of modules. Section 2.2 is devoted to monomial ideals, our main subject, and their irredundant  $\mathfrak{m}$ -irreducible decompositions. Section 2.3 contains a brief discussion of regular sequences. Section 2.4 introduces some material from homological algebra needed to define **Ext** modules. The notions of depth, type, and Cohen-Macaulayness occupy Section 2.5. Section 2.6 contains an account of graded rings and modules, and closes with a fact that a polynomial ring  $R = A[X_1, \dots, X_d]$  behaves like a local ring with the (homogeneous) maximal ideal  $\mathfrak{X} = (X_1, \dots, X_d)$  when  $R$  is regarded as a graded ring over  $A$  when  $A$  is a local ring, e.g., a field. Section 2.7 provides a way to compute the type of  $R/I$  when  $I$  is a monomial ideal in  $R$  and has an irredundant parametric decomposition.

**Convention.** In this chapter, let  $d$  be a positive integer,  $R$  a commutative ring with identity,  $M$  an  $R$ -module,  $I \subseteq R$  an ideal, and  $\mathfrak{p} \subseteq R$  a prime ideal.

### 2.1 Local Rings

There are several invariants defined in terms of local ring, so we first recall the definition of local rings and some relevant properties to be used later.

**Definition 2.1.1.** We say  $R$  is *local* if it has a unique maximal ideal  $\mathfrak{m}$ , also known as “*quasi-local*”, that is,  $R$  has finitely many maximal ideals. The *residue field* of  $R$  is  $R/\mathfrak{m}$ .

“Assume  $(R, \mathfrak{m}, k)$  is local” or “assume  $(R, \mathfrak{m})$  is local”, means that  $R$  is a local ring and  $\mathfrak{m}$  is the unique maximal ideal of  $R$  and  $k = R/\mathfrak{m}$ .

**Example 2.1.2.** Let  $\mathfrak{k}$  be a field.

(a)  $\mathfrak{k}$  is local with the maximal ideal  $(0)$ .

(b) Let  $n \geq 1$  and  $p$  be prime in  $\mathbb{Z}$ . Then  $\mathbb{Z}/(p^n)$  is local with the maximal ideal  $(p)/(p^n)$ .

(c) Let  $R = \mathfrak{k}[X_1, \dots, X_d]/(X_1^{a_1}, \dots, X_d^{a_d})$ , where  $a_i \geq 1$  for  $i = 1, \dots, d$ . Then  $R$  is local with  $\mathfrak{m} = (X_1, \dots, X_d)/(X_1^{a_1}, \dots, X_d^{a_d})$ .

**Definition 2.1.3.** Let  $U \subseteq R$  be multiplicatively closed and  $1 \in U$ . The *localization of  $M$  with respect to  $U$*  is defined to be

$$U^{-1}M = \{\text{equivalence classes from } M \times U \text{ under } \sim\},$$

where  $(m, u) \sim (n, u)$  if there exists  $w \in U$  such that  $w(vm - un) = 0$ . Denote the equivalence class of  $(m, u)$  as  $\frac{m}{u}$  or  $m/u$ .

Localization is a useful technique of reducing many problems in commutative algebra to those about local rings.

**Notation 2.1.4.** By the definition of prime ideals, we have that  $R \setminus \mathfrak{p}$  is multiplicatively closed. Set

$$M_{\mathfrak{p}} = (R \setminus \mathfrak{p})^{-1}M.$$

In particular, we have that  $R_{\mathfrak{p}} = (R \setminus \mathfrak{p})^{-1}R$ ,  $I_{\mathfrak{p}} = (R \setminus \mathfrak{p})^{-1}I = (R \setminus \mathfrak{p})^{-1}RI = IR_{\mathfrak{p}}$ , and  $(R/I)_{\mathfrak{p}} = (R \setminus \mathfrak{p})^{-1}(R/I)$ .

**Fact 2.1.5.**  $(R_{\mathfrak{p}}, \mathfrak{p}_{\mathfrak{p}})$  is a local ring.

**Fact 2.1.6.** Let  $\pi : R \rightarrow R/I$  be the natural surjection. We have that  $(R/I)_{\mathfrak{p}} \cong R_{\mathfrak{p}}/I_{\mathfrak{p}}$ . So  $(R/I)_{\mathfrak{p}} \neq 0$  if and only if  $I_{\mathfrak{p}} \subsetneq R_{\mathfrak{p}}$  if and only if  $1/1 \notin I_{\mathfrak{p}}$ . In fact,  $(R/I)_{\mathfrak{p}} \neq 0$  if and only if  $I \subseteq \mathfrak{p}$ . Indeed, if  $I \not\subseteq \mathfrak{p}$ , then  $I \cap (R \setminus \mathfrak{p}) \neq \emptyset$ , so there exists  $x \in I$  such that  $x \in (R \setminus \mathfrak{p})$  and  $1/1 \sim x/x \in I_{\mathfrak{p}}$ . On the other hand, if  $(R/I)_{\mathfrak{p}} = 0$ , then  $\bar{1}/u = 0$  for any  $u \in (R \setminus \mathfrak{p})$ , implying that there exists  $u'' \in (R \setminus \mathfrak{p})$  such that  $\overline{u''} = u''\bar{1} = 0$ , implying that  $u'' \in I$ , it follows that  $I \cap (R \setminus \mathfrak{p}) \neq \emptyset$ , therefore  $I \not\subseteq \mathfrak{p}$ . Thus, in summary,  $(R/I)_{\mathfrak{p}} \neq 0$  if and only if  $I \cap (R \setminus \mathfrak{p}) = \emptyset$  if and only if  $I \subseteq \mathfrak{p}$ .

## 2.2 Monomial Ideals

In this section, we introduce monomial ideals and their irredundant m-irreducible decompositions, and most of the definitions can be found in [9]. Let  $A$  be a non-zero commutative ring with identity and  $R = A[X_1, \dots, X_d]$  unless otherwise stated. Set  $\mathfrak{X} = (X_1, \dots, X_d)R$ , the ideal generated by all variables in  $R$  and  $\mathbb{N}_0 = \{0, 1, 2, \dots\}$ .

**Definition 2.2.1.** A *monomial* in elements  $X_1, \dots, X_d \in R$  is an element of the form  $X_1^{n_1} \cdots X_d^{n_d}$  in  $R$ , where  $n_1, \dots, n_d \in \mathbb{N}_0$ . For short, we write  $\underline{n} = (n_1, \dots, n_d) \in \mathbb{N}_0^d$  and  $\underline{X}^{\underline{n}} = X_1^{n_1} \cdots X_d^{n_d}$ .

**Definition 2.2.2.** Denote the set of monomials in  $R$  by

$$[[R]] = \{\underline{X}^{\underline{n}} \mid \underline{n} \in \mathbb{N}_0^d\}.$$

**Definition 2.2.3.** A *monomial ideal*  $I$  in  $R$  is an ideal generated by monomials in  $X_1, \dots, X_d$ , i.e., elements of the form  $\underline{X}^{\underline{n}}$  with  $\underline{n} \in \mathbb{N}_0^d$ .

**Remark.** The trivial ideals  $0$  and  $R$  are monomial ideals since  $0 = (\emptyset)R$  and  $R = (1)R = (X_1^0 \cdots X_d^0)R$ .

**Definition 2.2.4.** A monomial  $\underline{X}^{\underline{n}}$  with  $\underline{n} \in \mathbb{N}_0^d$  is *square-free* if  $n_i = 0$  or  $1$  for  $i = 1, \dots, d$ . A monomial ideal  $I$  of  $R$  is *square-free* if it is generated by square-free monomials.

**Example 2.2.5.** We have that  $I_1 = (X_1X_2, X_3)R$  and  $I_2 = (X_1^2, X_2, X_1X_3^3)R$  are monomial ideals in  $R = A[X_1, X_2, X_3]$ , but only  $I_1$  is a square-free monomial ideal.

**Assumption.** For the remainder of this section, let  $I \subseteq R$  be a monomial ideal.

**Fact 2.2.6** (Dickson's Lemma [9, Theorem 1.3.1]).  $I$  is finitely generated by a set of monomials.

**Definition 2.2.7.** Denote the set of monomials in  $I$  by

$$[[I]] = \{\underline{X}^{\underline{n}} \in I \mid \underline{n} \in \mathbb{N}_0^d\} = I \cap [[R]].$$

**Fact 2.2.8.** [9, Lemma 1.1.10] For each  $f \in I$ , each monomial occurring in  $f$  is in  $I$ .

**Definition 2.2.9.** Let  $f = \underline{X}^{\underline{n}} \in [[R]]$ . The *support* of  $f$  is the set of variables that appear in  $f$ :

$$\text{Supp}(f) = \{i \in \{1, \dots, d\} : n_i \geq 1\} = \{i \in \{1, \dots, d\} : X_i \mid f\}.$$

The *reduction* of  $f$  is the monomial achieved by reducing all non-zero exponents down to 1:

$$\text{red}(f) = \prod_{i \in \text{Supp}(f)} X_i = \prod_{X_i | f} X_i.$$

**Example 2.2.10.**  $\text{Supp}(X_1^5 X_3^4) = \{1, 3\}$  and  $\text{red}(X_1^5 X_3^4) = X_1 X_3$ .

**Definition 2.2.11.** Define the *monomial radical* of  $I$  by

$$\text{m-rad}(I) = (\text{rad}(I) \cap \llbracket R \rrbracket)R,$$

where  $\text{rad}(I)$  is the *radical* of  $I$ , defined by

$$\text{rad}(I) = \sqrt{I} = \{x \in R \mid x^n \in I, \forall n \gg 0\} = \{x \in R \mid x^n \in I \text{ for some } n \geq 1\}.$$

**Remark.** Example 2.2.13 shows that  $\text{rad}(I)$  may not be a monomial ideal. This is due to the fact that the ring  $A$  may have nilpotents. See Section 2.4 [9] for more details about this phenomenon.

**Fact 2.2.12.** [9, Theorem 2.3.7] Assume  $I = (S)R$  for some  $S \subseteq \llbracket R \rrbracket$ , then we have that  $\text{m-rad}(I) = (\text{red}(s) \mid s \in S)R$ .

It is important to note that you can use the generators.

**Example 2.2.13.** The monomial ideal  $I = (X^3 Y^2, XY^3, Y^5)R$  in  $R = A[X, Y]$  has

$$\text{m-rad}(I) = (\text{red}(X^3 Y^2), \text{red}(XY^3), \text{red}(Y^5))R = (XY, XY, Y)R = (Y)R.$$

If  $A = \mathbb{Z}/4\mathbb{Z}$ , then  $\text{rad}(I) = (2, Y)R \neq \text{m-rad}(I)$ .

**Definition 2.2.14.**  $I$  is *m-reducible* if there exist monomial ideals  $J, K \subseteq R$  such that  $I = J \cap K$  and  $J \neq I$  and  $K \neq I$ .  $I$  is *m-irreducible* if it is not m-reducible and  $I \neq R$ .

**Fact 2.2.15.** [9, Theorem 3.1.4] The zero ideal  $I = (0)$  is m-irreducible. A non-zero  $I$  is m-irreducible if and only if it can be generated by “pure powers”, i.e., if and only if  $I = (X_{i_1}^{a_1}, \dots, X_{i_t}^{a_t})R$  for some  $t \geq 1$  and  $a_i \geq 1$  for  $i = 1, \dots, t$ .

**Example 2.2.16.** The monomial ideal  $(X^3, X^2 Y^2, Y^4)R$  in  $R = A[X, Y]$  is m-reducible because it cannot be generated by “pure powers”. One can also see this from the non-trivial decomposition

$$(X^3, X^2Y^2, Y^4)R = (X^2, Y^4)R \cap (X^3, Y^2)R.$$

**Definition 2.2.17.** An *m-irreducible decomposition* of  $I$  is an expression  $I = \bigcap_{i=1}^n J_i$  with  $n \geq 1$  such that monomial ideals  $J_1, \dots, J_n \subseteq R$  are m-irreducible.

**Example 2.2.18.** The monomial ideal  $I = (X^2, XY, Y^3)R$  in  $R = A[X, Y]$  has an m-irreducible decomposition  $I = (X, Y^3)R \cap (X^2, Y)R$ . The intersection in Example 2.2.16 is another m-irreducible decomposition for the corresponding ideal.

**Fact 2.2.19.** [9, Theorem 3.3.3] If  $I \neq R$ , then  $I$  has an m-irreducible decomposition.

**Definition 2.2.20.** An m-irreducible decomposition  $I = \bigcap_{i=1}^n J_i$  is *redundant* if  $I = \bigcap_{i \neq k} J_i$  for some  $k \in \{1, \dots, n\}$ . An m-irreducible decomposition  $I = \bigcap_{i=1}^n J_i$  is *irredundant* if it is not redundant, that is, if every  $k \in \{1, \dots, n\}$  satisfies  $I \neq \bigcap_{i \neq k} J_i$ . As  $I = \bigcap_{i=1}^n J_i \subseteq \bigcap_{i \neq k} J_i$  holds automatically, the given decomposition is irredundant if and only if every  $k \in \{1, \dots, d\}$  satisfies  $I \subsetneq \bigcap_{i \neq k} J_i$ .

**Example 2.2.21.** The m-irreducible decompositions in Examples 2.2.16 and 2.2.18 are irredundant.

The following two facts provide existence and uniqueness for irredundant m-irreducible decompositions.

**Fact 2.2.22.** [9, Corollary 3.3.8] If  $I \neq R$ , then  $I$  has an irredundant m-irreducible decomposition.

**Fact 2.2.23.** [9, Theorem 3.3.9] If  $I$  has two irredundant m-irreducible decompositions  $I = \bigcap_{i=1}^n I_i$  and  $I = \bigcap_{j=1}^m J_j$ , then  $n = m$  and there exists  $\sigma \in S_m$  such that  $I_i = J_{\sigma(i)}$  for  $i = 1, \dots, n$ , where  $S_n$  is the permutation group.

An important concept for Cohen-Macaulayness is next.

**Definition 2.2.24.** The *prime spectrum* of  $R$  is

$$\text{Spec}(R) = \{\text{prime ideals of } R\}.$$

By convention, we have that  $R \notin \text{Spec}(R)$ . Let  $V(I)$  denote the *set of prime ideals in  $R$  containing  $I$* :

$$V(I) = \{\mathfrak{p} \in \text{Spec}(R) \mid I \subseteq \mathfrak{p}\}.$$



Let  $M$  be an  $R$ -module. The *support* of  $M$  is the set

$$\text{Supp}_R(M) = \{\mathfrak{p} \in \text{Spec}(R) \mid M_{\mathfrak{p}} \neq 0\}.$$

**Fact 2.2.25.** It is straightforward to show that

$$\text{Supp}_R(R) = \text{Spec}(R),$$

and by Fact 2.1.6, we have

$$\text{Supp}_R(R/I) = V(I).$$

**Definition 2.2.26.** Let  $M$  be an  $R$ -module. The *Krull dimension* of  $M$  is

$$\dim_R(M) = \sup\{n \geq 0 \mid \exists \text{ a chain } \mathfrak{p}_0 \subsetneq \mathfrak{p}_1 \subsetneq \cdots \subsetneq \mathfrak{p}_n \text{ in } \text{Supp}_R(M)\}.$$

Set  $\dim(R) = \dim_R(R)$ .

Based on Fact 2.2.25, we have the following Krull dimension computations for rings and quotient rings.

**Fact 2.2.27.** (a) The *Krull dimension* of  $R$  is

$$\dim(R) = \sup\{n \geq 0 \mid \exists \text{ a chain } \mathfrak{p}_0 \subsetneq \mathfrak{p}_1 \subsetneq \cdots \subsetneq \mathfrak{p}_n \text{ in } \text{Spec}(R)\}.$$

(b) The *Krull dimension* of  $R/I$  is

$$\dim(R/I) = \sup\{n \geq 0 \mid \exists \text{ a chain } \mathfrak{p}_0 \subsetneq \mathfrak{p}_1 \subsetneq \cdots \subsetneq \mathfrak{p}_n \text{ in } V(I)\}.$$

**Fact 2.2.28.** [9, Theorem 5.1.2] Let  $A$  be a field and  $I = \bigcap_{i=1}^m J_i$  an  $m$ -irreducible decomposition. Then the Krull dimension is  $\dim(R/I) = d - n$ , where  $n$  is the smallest number of generators needed for one of the  $J_i$ 's.

Fact 2.2.28 provides us a simple formula to compute  $\dim(R/I)$ .

**Example 2.2.29.** The monomial ideal  $I = (X_1X_2, X_2^2X_3^2, X_3X_4)$  in  $R = A[X_1, X_2, X_3, X_4]$  has an

(irredundant) m-irreducible decomposition

$$I = (X_1, X_3)R \cap (X_2, X_3)R \cap (X_1, X_2^2, X_4)R \cap (X_2, X_4)R \cap (X_1, X_3^2, X_4)R.$$

Therefore, by Fact 2.2.28, we have that  $\dim(R/I) = 4 - 2 = 2$ .

**Definition 2.2.30.** Let  $I = \bigcap_{i=1}^m J_i$  be an irredundant m-irreducible decomposition. Let  $n_i$  be the smallest number of generators needed for  $J_i$  for  $i = 1, \dots, m$ . We say that  $I$  is *m-unmixed* if  $n_1 = \dots = n_m$ . We say that  $I$  is *m-mixed* if it is not m-unmixed, i.e., there exist  $i, j \in \{1, \dots, m\}$  such that  $n_i \neq n_j$ .

**Fact 2.2.31.** If  $A$  is a field, then  $I$  is m-unmixed if and only if  $I$  is unmixed.

**Example 2.2.32.** The monomial ideals in Examples 2.2.16 and 2.2.18 are m-unmixed. The monomial ideal in Example 2.2.29 is m-mixed.

**Definition 2.2.33.** A *parameter ideal* in  $R$  is an ideal of the form  $(X_1^{a_1}, \dots, X_d^{a_d})$  with  $a_1, \dots, a_d \geq 1$ . For  $\underline{X}^{\underline{n}} = X_1^{n_1} \cdots X_d^{n_d} \in \llbracket R \rrbracket$  with  $\underline{n} \in \mathbb{N}_0^d$ , set

$$P_R(\underline{X}^{\underline{n}}) = (X_1^{n_1+1}, \dots, X_d^{n_d+1})R.$$

Note that

$$\text{m-rad}(P_R(\underline{X}^{\underline{n}})) = (\text{red}(X_1^{n_1+1}), \dots, \text{red}(X_d^{n_d+1}))R = (X_1, \dots, X_d)R = \mathfrak{X}.$$

**Example 2.2.34.** The monomial ideal  $I = (X_1^2, X_2, X_3^8)R$  is a parameter ideal in  $R = A[X_1, X_2, X_3]$  but not in  $R = A[X_1, X_2, X_3, X_4]$ .

**Definition 2.2.35.** A *parametric decomposition* of  $I$  is an m-irreducible decomposition of  $I$  of the form  $I = \bigcap_{i=1}^n P_R(f_i)$  with  $f_i \in \llbracket R \rrbracket$ .

**Example 2.2.36.** The m-irreducible decompositions in Examples 2.2.16 and 2.2.18 are irredundant parametric decompositions.

**Fact 2.2.37.** [9, Exercise 2.4.5, Theorem 6.1.5 and Exercise 5.1.7]  $I$  has a parametric decomposition if and only if  $\text{m-rad}(I) = \mathfrak{X}$ . Furthermore, if  $A$  is a field, then  $\text{m-rad}(I) = \mathfrak{X}$  is equivalent to  $\dim(R/I) = 0$ .

We end this section by exhibiting one technique for computing m-irreducible decompositions of arbitrary monomial ideals.

**Fact 2.2.38.** [9, Theorem 7.5.1] Let  $I = (\underline{X}^{a_1}, \dots, \underline{X}^{a_n})R$  with  $\underline{a}_i = (a_{i,1}, \dots, a_{i,d}) \in \mathbb{N}_0^d$  for  $i = 1, \dots, n$ . Then

$$I = \bigcap_{i_1=1}^d \cdots \bigcap_{i_n=1}^d (X_{i_1}^{a_{1,i_1}}, \dots, X_{i_n}^{a_{n,i_n}}).$$

**Example 2.2.39.** Let  $R = A[X_1, X_2]$  and  $I = (X_1^2 X_2, X_1 X_3)R$ . Then by Fact 2.2.38,

$$\begin{aligned} I &= (X_1^2, X_1)R \cap (X_1^2, X_2^0)R \cap (X_1^2, X_3)R \\ &\quad \cap (X_2, X_1)R \cap (X_2, X_2^0)R \cap (X_2, X_3)R \\ &\quad \cap (X_3^0, X_1)R \cap (X_3^0, X_2^0)R \cap (X_3^0, X_3)R \\ &= (X_1)R \cap R \cap (X_1^2, X_3)R \cap (X_1, X_2)R \cap R \cap (X_2, X_3)R \cap R \cap R \\ &= (X_1)R \cap (X_1^2, X_3)R \cap (X_2, X_3)R. \end{aligned}$$

## 2.3 Regular Sequences

The interplay between regular sequences and certain homological invariants is one of the key techniques used to compute the type of a module.

**Definition 2.3.1.** An element  $x \in R$  is a *non-zero divisor* on  $M$  if the multiplication by  $x$  map  $M \xrightarrow{x} M$  is 1-1; equivalently, for  $m \in M$ , if  $xm = 0$ , then  $m = 0$ . Set

$$\text{NZD}_R(M) = \{a \in R \mid a \text{ is a non-zero divisor on } M\}.$$

**Definition 2.3.2.** An element  $x \in R$  is *weakly  $M$ -regular* if  $x \in \text{NZD}_R(M)$ . A weakly  $M$ -regular element  $x \in R$  is  *$M$ -regular* if  $xM \neq M$ .

**Definition 2.3.3.** A sequence  $a_1, \dots, a_n \in R$  is *weakly  $M$ -regular* if

- (a)  $a_1$  is weakly  $M$ -regular and
- (b)  $a_i$  is weakly  $\frac{M}{(a_1, \dots, a_{i-1})M}$ -regular for  $i = 2, \dots, n$ .

A sequence  $a_1, \dots, a_n \in R$  is  *$M$ -regular* if

(a)  $a_1, \dots, a_n$  is weakly  $M$ -regular and

(b)  $(a_1, \dots, a_n)M \neq M$ .

**Example 2.3.4.** A list of variables  $X_1, \dots, X_n$  is  $A[X_1, \dots, X_n]$ -regular for any non-zero commutative ring  $A$ .

**Remark.** Note that for  $a_1, \dots, a_i \in R$ , we have

$$\frac{M}{(a_1, \dots, a_i)M} \stackrel{\textcircled{1}}{\cong} \frac{M/(a_1, \dots, a_{i-1})M}{(a_1, \dots, a_i)M/(a_1, \dots, a_{i-1})M} \cong \frac{M/(a_1, \dots, a_{i-1})M}{a_i M/(a_1, \dots, a_{i-1})M},$$

where  $\textcircled{1}$  is from an isomorphism theorem for modules. Thus, we have that  $a_i M/(a_1, \dots, a_{i-1})M \neq M/(a_1, \dots, a_{i-1})M$  if and only if  $M/(a_1, \dots, a_i)M \neq 0$ . This observation justifies the following equivalent definition for  $M$ -regular sequences.

**Definition 2.3.5.** A sequence  $a_1, \dots, a_n \in R$  is *weakly  $M$ -regular* if

(a)  $a_1 \in \text{NZD}_R(M)$ , and

(b)  $a_i \in \text{NZD}_R(M/(a_1, \dots, a_{i-1})M)$  for  $i = 2, \dots, n$ .

**Remark.** If  $(R, \mathfrak{m})$  is local with  $a_1, \dots, a_n \in \mathfrak{m}$ , and  $M$  is non-zero and finitely generated, then by Nakayama's lemma, we have that  $(a_1, \dots, a_n)M \subseteq \mathfrak{m}M \subsetneq M$ . So  $a_1, \dots, a_n$  is  $M$ -regular if and only if it is weakly  $M$ -regular.

**Definition 2.3.6.** A sequence  $a_1, \dots, a_n \in R$  is a *maximal  $M$ -regular sequence* if  $a_1, \dots, a_n$  is an  $M$ -regular sequence such that for all  $b \in R$ , the longer sequence  $a_1, \dots, a_n, b$  is not  $M$ -regular.

## 2.4 Ext via Projective Resolutions

In this section, let  $N$  be another  $R$ -module. We will present some definitions and facts from homological algebra leading to the definition of Ext.

**Definition 2.4.1.** A sequence  $A \xrightarrow{f} B \xrightarrow{g} C$  of  $R$ -module homomorphisms is *exact* at  $B$  if  $\text{Im}(f) = \text{Ker}(g)$ . Note that  $\text{Im}(f) \subseteq \text{Ker}(g)$  if and only if  $g \circ f = 0$ .

More generally, a sequence of  $R$ -module homomorphism

$$\cdots \xrightarrow{d_{i+1}} X_i \xrightarrow{d_i} X_{i-1} \xrightarrow{d_{i-1}} \cdots$$

is *exact* if  $\text{Im}(d_{i+1}) = \text{Ker}(d_i)$  for all  $i \in \mathbb{Z}$ .

**Fact 2.4.2.** We have the following facts:

- (a) The sequence  $0 \rightarrow A \xrightarrow{f} A'$  of  $R$ -module homomorphisms is exact (at  $A$ ) if and only if  $f$  is 1-1.
- (b) The sequence  $B' \xrightarrow{g} B \rightarrow 0$  of  $R$ -module homomorphisms is exact (at  $B$ ) if and only if  $g$  is onto.
- (c) The sequence  $0 \rightarrow A \xrightarrow{f} B \xrightarrow{g} C \rightarrow 0$  of  $R$ -module homomorphisms is exact if and only if  $f$  is 1-1,  $g$  is onto and  $\text{Im}(f) = \text{Ker}(g)$ .

**Definition 2.4.3.** A *short exact sequence* is an exact sequence of  $R$ -module homomorphisms of the form

$$0 \longrightarrow U \xrightarrow{\alpha} V \xrightarrow{\beta} W \longrightarrow 0.$$

**Definition 2.4.4.** A *homomorphism of short exact sequences* of  $0 \rightarrow A \xrightarrow{f} B \xrightarrow{g} C \rightarrow 0$  and  $0 \rightarrow A' \xrightarrow{f'} B' \xrightarrow{g'} C' \rightarrow 0$  is a triple  $(\alpha, \beta, \gamma)$  of  $R$ -module homomorphisms such that the following diagram commutes:

$$\begin{array}{ccccccccc} 0 & \longrightarrow & A & \xrightarrow{f} & B & \xrightarrow{g} & C & \longrightarrow & 0 \\ & & \downarrow \alpha & & \downarrow \beta & & \downarrow \gamma & & \\ 0 & \longrightarrow & A' & \xrightarrow{f'} & B' & \xrightarrow{g'} & C' & \longrightarrow & 0. \end{array}$$

**Fact 2.4.5** (The Short Five Lemma [5, Proposition 10.24]). Let  $(\alpha, \beta, \gamma)$  be a homomorphism of short exact sequences

$$\begin{array}{ccccccccc} 0 & \longrightarrow & A & \xrightarrow{f} & B & \xrightarrow{g} & C & \longrightarrow & 0 \\ & & \downarrow \alpha & & \downarrow \beta & & \downarrow \gamma & & \\ 0 & \longrightarrow & A' & \xrightarrow{f'} & B' & \xrightarrow{g'} & C' & \longrightarrow & 0. \end{array}$$

- (a) If  $\alpha$  and  $\gamma$  are 1-1, then so is  $\beta$ .
- (b) If  $\alpha$  and  $\gamma$  are onto, then so is  $\beta$ .
- (c) If  $\alpha$  and  $\gamma$  are isomorphisms, then so is  $\beta$ .

**Definition 2.4.6.** A short exact sequence of  $R$ -module homomorphisms  $0 \rightarrow A \xrightarrow{f} B \xrightarrow{g} C \rightarrow 0$  is *split* if and only if it is equivalent to the canonical exact sequence  $0 \rightarrow A \xrightarrow{\epsilon} A \oplus C \xrightarrow{\rho} C \rightarrow 0$ , i.e., if and only if there exists a commutative diagram

$$\begin{array}{ccccccccc} 0 & \longrightarrow & A & \xrightarrow{f} & B & \xrightarrow{g} & C & \longrightarrow & 0 \\ & & \downarrow = & & \downarrow \beta & & \downarrow = & & \\ 0 & \longrightarrow & A & \xrightarrow{\epsilon} & A \oplus C & \xrightarrow{\rho} & C & \longrightarrow & 0. \end{array}$$

In this event,  $\beta$  is an isomorphism by the short five lemma, so  $B \cong A \oplus C$ .

**Notation 2.4.7.**

$$\mathrm{Hom}_R(M, N) := \{R\text{-module homomorphisms } f : M \rightarrow N\},$$

which is an  $R$ -module because  $R$  is commutative.

Let  $A, B$  be  $R$ -modules. For each  $f \in \mathrm{Hom}_R(A, B)$ , define

$$\begin{aligned} f^* = \mathrm{Hom}_R(f, N) : \mathrm{Hom}_R(B, N) &\longrightarrow \mathrm{Hom}_R(A, N) \\ \phi &\longmapsto \phi \circ f. \end{aligned}$$

$$\begin{array}{ccc} A & \xrightarrow{f} & B \\ & \searrow f^*(\phi) & \downarrow \phi \\ & & N \end{array}$$

Then  $f^*$  is an  $R$ -module homomorphism.

**Fact 2.4.8.**  $\mathrm{Hom}_R(-, N)$  is a *contravariant functor*, i.e.,

- (a) it respects identity maps:  $\mathrm{Hom}_R(\mathrm{id}_M, N) = \mathrm{id}_{\mathrm{Hom}_R(M, N)}$ , and
- (b) it respects compositions: for all  $R$ -module homomorphisms  $A \xrightarrow{\alpha} B \xrightarrow{\beta} C$ ,

$$\mathrm{Hom}_R(\beta \circ \alpha, N) = \mathrm{Hom}_R(\alpha, N) \circ \mathrm{Hom}_R(\beta, N).$$

Or equivalently,  $(\beta \circ \alpha)^* = \alpha^* \circ \beta^*$ , i.e., the following diagram commutes:

$$\begin{array}{ccccc} \mathrm{Hom}(-, N) : & \mathrm{Hom}_R(A, N) & \xleftarrow{\mathrm{Hom}_R(\alpha, N)} & \mathrm{Hom}_R(B, N) & \\ & \swarrow \mathrm{Hom}_R(\beta \circ \alpha, N) & & \uparrow \mathrm{Hom}_R(\beta, N) & \\ & & & \mathrm{Hom}_R(C, N) & \end{array}$$

**Fact 2.4.9** (Left Exactness of  $\mathrm{Hom}(-, N)$  [5, Theorem 10.33]). Let  $A \xrightarrow{\alpha} B \xrightarrow{\beta} C \rightarrow 0$  be exact. Then the induced sequence  $0 \rightarrow \mathrm{Hom}(C, N) \xrightarrow{\beta^*} \mathrm{Hom}(B, N) \xrightarrow{\alpha^*} \mathrm{Hom}(A, N)$  is exact.

**Remark.** The functor  $\mathrm{Hom}(N, -)$  is defined similarly with notation  $f_* = \mathrm{Hom}(N, f)$ . This functor

is *covariant*. It is left exact, i.e., if  $0 \rightarrow A \xrightarrow{f} B \xrightarrow{g} C$  is an exact sequence of  $R$ -module homomorphisms, then the induced sequence  $0 \rightarrow \text{Hom}(N, A) \xrightarrow{f_*} \text{Hom}(N, B) \xrightarrow{g_*} \text{Hom}(N, C)$  is exact.

**Fact 2.4.10.** [5, Theorem 10.30] The following conditions are equivalent.

- (i)  $\text{Hom}_R(N, -)$  transforms  $R$ -module epimorphisms into  $R$ -module epimorphisms.
- (ii)  $\text{Hom}_R(N, -)$  transforms short exact sequences of  $R$ -module homomorphisms into short exact sequences of  $R$ -module homomorphisms.
- (iii)  $\text{Hom}_R(N, -)$  transforms exact sequences of  $R$ -module homomorphisms into exact sequences of  $R$ -module homomorphisms.
- (iv) Every short exact sequence  $0 \rightarrow A \rightarrow B \rightarrow N \rightarrow 0$  of  $R$ -module homomorphisms splits.
- (v) If the sequence  $B \xrightarrow{\beta} C \rightarrow 0$  of  $R$ -module homomorphisms is exact, then every  $R$ -module homomorphism from  $N$  to  $C$  lifts to an  $R$ -module homomorphism into  $B$ , i.e., given  $\phi \in \text{Hom}_R(N, C)$ , there is a map  $\psi \in \text{Hom}_R(N, B)$  making the following diagram commute:

$$\begin{array}{ccc} & N & \\ \exists \psi \swarrow & \downarrow \phi & \\ B & \xrightarrow{\beta} C & \longrightarrow 0. \end{array}$$

- (vi) There exists an  $R$ -module  $N'$  such that  $N \oplus N'$  is free, i.e.,  $N$  is a summand of a free  $R$ -module.

**Definition 2.4.11.** An  $R$ -module  $P$  is called *projective* if it satisfies any of the equivalent conditions of Fact 2.4.10.

**Definition 2.4.12.** A *chain complex* or  *$R$ -complex* is a sequence of  $R$ -module homomorphisms

$$M_\bullet = \cdots \xrightarrow{\partial_{i+1}^M} M_i \xrightarrow{\partial_i^M} M_{i-1} \xrightarrow{\partial_{i-1}^M} \cdots$$

such that  $\partial_{i-1}^M \circ \partial_i^M = 0$  for all  $i \in \mathbb{Z}$ . We say  $M_i$  is the module in (homological) *degree*  $i$  in the  $R$ -complex  $M_\bullet$ .

The  $i^{\text{th}}$  *homology module* of an  $R$ -complex  $M_\bullet$  is the  $R$ -module

$$H_i(M_\bullet) = \text{Ker}(\partial_i^M) / \text{Im}(\partial_{i+1}^M).$$

**Definition 2.4.13.** A *projective resolution* of  $M$  over  $R$  or an  *$R$ -projective resolution* of  $M$  is an exact sequence of  $R$ -module homomorphisms

$$P_{\bullet}^+ = \cdots \xrightarrow{\partial_2^P} P_1 \xrightarrow{\partial_1^P} P_0 \xrightarrow{\tau} M \rightarrow 0$$

such that each  $P_i$  is a projective  $R$ -module.

The *truncated projective resolution* of  $M$  associated to  $P_{\bullet}^+$  is the  $R$ -complex

$$P_{\bullet} = \cdots \xrightarrow{\partial_2^P} P_1 \xrightarrow{\partial_1^P} P_0 \rightarrow 0.$$

By convention, we have that  $P_i = 0$  for all  $i \leq -1$  and  $\partial_i^P = 0$  for all  $i \leq 0$ . Define the  $R$ -complex  $\text{Hom}(P_{\bullet}^+, N)$  as follows:

$$\text{Hom}(P_{\bullet}^+, N) = 0 \rightarrow M^* \xrightarrow{\tau^*} P_0^* \xrightarrow{(\partial_1^P)^*} P_1^* \xrightarrow{(\partial_2^P)^*} \cdots \xrightarrow{(\partial_{i-1}^P)^*} P_{i-1}^* \xrightarrow{(\partial_i^P)^*} P_i^* \xrightarrow{(\partial_{i+1}^P)^*} \cdots,$$

where we set  $P_i^* = \text{Hom}(P_i, N)$  and  $(\partial_i^P)^* = \text{Hom}(\partial_i^P, N)$  for  $i \geq 0$ . Define the  $R$ -complex  $P_{\bullet}^*$  as follows:

$$P_{\bullet}^* = \text{Hom}(P_{\bullet}, N) = 0 \rightarrow P_0^* \xrightarrow{(\partial_1^P)^*} P_1^* \xrightarrow{(\partial_2^P)^*} \cdots \xrightarrow{(\partial_{i-1}^P)^*} P_{i-1}^* \xrightarrow{(\partial_i^P)^*} P_i^* \xrightarrow{(\partial_{i+1}^P)^*} \cdots.$$

Let  $P_i^*$  be in degree  $-i$ , i.e.,  $P_i^* = (P^*)_{-i}$  for  $i \in \mathbb{Z}$ . Then

$$\begin{array}{ccccccccccc} P_{\bullet}^* = 0 & \longrightarrow & P_0^* & \xrightarrow{(\partial_1^P)^*} & P_1^* & \xrightarrow{(\partial_2^P)^*} & \cdots & \xrightarrow{(\partial_{i-1}^P)^*} & P_{i-1}^* & \xrightarrow{(\partial_i^P)^*} & P_i^* & \xrightarrow{(\partial_{i+1}^P)^*} & \cdots \\ & & \parallel & & \parallel & & & & \parallel & & \parallel & & \\ P_{\bullet}^* = 0 & \rightarrow & (P^*)_0 & \xrightarrow{\partial_0^{P^*}} & (P^*)_{-1} & \xrightarrow{\partial_{-1}^{P^*}} & \cdots & \xrightarrow{\partial_{-i+2}^{P^*}} & (P^*)_{-i+1} & \xrightarrow{\partial_{-i+1}^{P^*}} & (P^*)_{-i} & \xrightarrow{\partial_{-i}^{P^*}} & \cdots \end{array}$$

So

$$\partial_i^{P^*} = (\partial_{-i+1}^P)^*, \quad \forall i \in \mathbb{Z}.$$

By convention, we have that  $(P^*)_i = P_{-i}^* = 0^* = 0$  and  $\partial_i^{P^*} = (\partial_{-i+1}^P)^* = 0^* = 0$  for all  $i \geq 1$ .

**Remark.** Because of the condition  $\partial_i^P \circ \partial_{i+1}^P = 0$  for  $i \geq 1$ , by Fact 2.4.8, we have

$$(\partial_{i+1}^P)^* \circ (\partial_i^P)^* = (\partial_i^P \circ \partial_{i+1}^P)^* = 0^* = 0, \quad \forall i \geq 1.$$



Thus,  $\text{Hom}(P_\bullet, N)$  and similarly  $\text{Hom}(P_\bullet^+, N)$  are  $R$ -complexes. However, these are not exact in general.

**Definition 2.4.14** (Ext via projective resolutions). Let  $P_\bullet^+$  be a projective resolution of  $M$ . Define the Ext module by

$$\text{Ext}_R^i(M, N) := \text{H}_{-i}(P_\bullet^*) = \text{Ker}(\partial_{-i}^{P^*}) / \text{Im}(\partial_{-i+1}^{P^*}) = \text{Ker}((\partial_{i+1}^P)^*) / \text{Im}((\partial_i^P)^*).$$

**Fact 2.4.15.** Let  $P_\bullet^+$  be a projective resolution of  $M$ . By the left exactness of  $\text{Hom}$ , we have an exact sequence:

$$0 \longrightarrow M^* \xrightarrow{\tau^*} P_0^* \xrightarrow{(\partial_1^P)^*} P_1^*.$$

Then we have

$$\text{Ext}_R^0(M, N) = \text{Ker}((\partial_1^P)^*) / \text{Im}(0) \cong \text{Ker}((\partial_1^P)^*) = \text{Im}(\tau^*) \cong M^* = \text{Hom}_R(M, N),$$

$$\text{Ext}_R^i(M, N) = \text{Ker}(\partial_{-i}^{P^*}) / \text{Im}(\partial_{-i+1}^{P^*}) = 0 / \text{Im}(\partial_{-i+1}^{P^*}) = 0, \quad \forall i \leq -1.$$

**Remark.**  $\text{Ext}_R^i(M, N)$  is well-defined, i.e., independent of the choices of projective resolution of  $M$ , by [11, Theorem VIII.5.2].

**Remark.** We can also define the Ext module via *injective modules*, but this is not needed for this dissertation.

## 2.5 Depth, Type, and Cohen-Macaulayness

In this section, we define the depth and the type of  $M$  when  $M \neq 0$ ,  $M$  is finitely generated, and  $(R, \mathfrak{m})$  is local.

**Assumption.** For this section, we assume that  $R$  is Noetherian,  $I$  is an ideal of  $R$ , and  $M$  is a finitely generated  $R$ -module.

The next fact is due to Rees.

**Fact 2.5.1.** [1, Theorem 1.2.5] If  $IM \neq M$ , then all maximal  $M$ -regular sequences in  $I$  have the same length, namely

$$\inf\{i \geq 0 \mid \text{Ext}_R^i(R/I, M) \neq 0\}.$$

Through Fact 2.5.1, we have the following definition:

**Definition 2.5.2.** [1, Definition 1.2.11] If  $IM \neq M$ , we define the *grade* of  $M$  on  $I$  by

$$\text{grade}_R(I; M) = \inf\{i \geq 0 \mid \text{Ext}_R^i(R/I, M) \neq 0\}.$$

If  $IM = M$ , then set  $\text{grade}_R(I; M) = \infty$ .

**Remark.** (a) By Fact 2.4.15 we also have  $\text{grade}_R(I; M) = \inf\{i \in \mathbb{Z} \mid \text{Ext}_R^i(R/I, M) \neq 0\}$ .

(b) If  $(R, \mathfrak{m})$  is local and  $M \neq 0$ , then by Nakayama's lemma,  $IM \subseteq \mathfrak{m}M \subsetneq M$ , so  $IM \neq M$ .

**Definition 2.5.3.** [1, Definition 1.2.8] If  $(R, \mathfrak{m}, k)$  is local and  $M \neq 0$ , we define the *depth* of  $M$  by

$$\text{depth}(M) = \text{grade}_R(\mathfrak{m}; M) = \inf\{i \geq 0 \mid \text{Ext}_R^i(k, M) \neq 0\}.$$

**Fact 2.5.4.** By Fact 2.5.1, the depth can be calculated as the maximum length among all  $M$ -regular sequences in  $\mathfrak{m}$ .

**Fact 2.5.5.** [1, Theorem 1.2.10] If  $f_1, \dots, f_r \in R$  is an  $R/I$ -regular sequence, then

$$\dim(R/(I + (f_1, \dots, f_r)R)) = \dim(R/I) - r,$$

$$\text{depth}(R/(I + (f_1, \dots, f_r)R)) = \text{depth}(R/I) - r.$$

**Definition 2.5.6.** [1, Definition 1.2.15] Let  $(R, \mathfrak{m}, k)$  be local and  $M \neq 0$ . Assume  $\text{depth}_R(M) = n$ .

The *type* of  $M$  is the positive integer

$$r_R(M) = \dim_k(\text{Ext}_R^n(k, M)).$$

**Definition 2.5.7.** [1, Definition 2.1.1] Let  $(R, \mathfrak{m}, k)$  be local and  $M \neq 0$ . Then  $M$  is a *Cohen-Macaulay module* if  $\text{depth}_R(M) = \dim_R(M)$ . If  $R$  itself is a Cohen-Macaulay module, then it is also called a *Cohen-Macaulay ring*.

## 2.6 Graded rings and modules

The rings we mainly work on are polynomial rings. They form an important class of graded rings. In this section, we exhibit a series of definitions and conclusions, most of which can be found in Section 1.5 of [1].

**Definition 2.6.1.** A *graded ring* is a ring  $R$  together with a decomposition  $R = \bigoplus_{i \in \mathbb{Z}} R_i$  (as a  $\mathbb{Z}$ -module) such that  $R_i R_j \subseteq R_{i+j}$  for all  $i, j \in \mathbb{Z}$ .

**Assumption.** For the remainder of this section, we assume that  $R$  be a graded ring.

**Definition 2.6.2.** A *graded module* is an  $R$ -module  $M$  together with a decomposition  $M = \bigoplus_{i \in \mathbb{Z}} M_i$  (as a  $\mathbb{Z}$ -module) such that  $R_i M_j \subseteq M_{i+j}$  for all  $i, j \in \mathbb{Z}$ . The elements  $x \in R_i$  are called *homogeneous* (of degree  $i$ ). One calls  $M_i$  the  $i^{\text{th}}$  *homogeneous* (or *graded*) *component* of  $M$ .

**Definition 2.6.3.** Let  $M$  be a graded  $R$ -module. An arbitrary element  $x \in M$  has a unique presentation  $x = \sum_i x_i$  as a sum of homogeneous elements  $x_i \in M_i$ . The elements  $x_i$  are called the *homogeneous components* of  $x$ .

**Definition 2.6.4.** An ideal  $I$  of  $R$  is *homogeneous* if  $I$  is generated by homogeneous elements of  $I$ .

**Definition 2.6.5.** Let  $M$  be a graded  $R$ -module and  $i \in \mathbb{Z}$ . Let  $M(i)$  denote the *shifted  $R$ -module*  $M$  with grading given by  $M(i)_n = M_{i+n}$ . One can also read  $M(i)$  as “ $M$  twisted by  $i$ ”.

**Definition 2.6.6.** Let  $M$  and  $N$  be graded  $R$ -modules, and  $n \in \mathbb{Z}$ . An  $R$ -module homomorphism  $\varphi : M \rightarrow N$  is called *homogeneous of degree  $n$*  if  $\varphi(M_i) \subseteq N_{i+n}$  for all  $i \in \mathbb{Z}$ . Denote by  $\text{Hom}_n(M, N)$  the group of homogeneous  $R$ -module homomorphisms of degree  $n$ . In particular, if  $\varphi \in \text{Hom}_0(M, N)$ , we call it a *homogeneous  $R$ -module homomorphism*.

If  $\varphi \in \text{Hom}_n(M, N)$ , then  $\varphi \in \text{Hom}_0(M, N(n))$  and  $\varphi \in \text{Hom}_0(M(-n), N)$  since  $\varphi(M_i) \subseteq N_{i+n}$  for all  $i \in \mathbb{Z}$  if and only if  $\varphi(M_{-n+i}) \subseteq N_i$  for all  $i \in \mathbb{Z}$ .

**Definition 2.6.7.** Let  $M$  and  $N$  be graded  $R$ -modules. Define  ${}^* \text{Hom}_R(M, N) = \bigoplus_{i \in \mathbb{Z}} \text{Hom}_i(M, N)$ , which is a submodule of  $\text{Hom}_R(M, N)$ . If  $P_\bullet$  is a graded projective resolution of  $M$ , then

$${}^* \text{Ext}_R^i(M, N) \cong H^i({}^* \text{Hom}_R(P_\bullet, N)), \quad \forall i \geq 0.$$

**Fact 2.6.8.** [1, p.33] If  $R$  is Noetherian and  $M$  is a finitely generated  $R$ -module, then  ${}^* \text{Ext}_R^i(M, N) = \text{Ext}_R^i(M, N)$  for all  $i \geq 0$ .

**Definition 2.6.9.** The *homogeneous prime spectrum* of  $R$  is

$$*\text{Spec}(R) = \{\text{homogeneous prime ideals of } R\}.$$

Let  $*V(I)$  denote the *set of homogeneous prime ideals in  $R$  containing  $I$* :

$$*V(I) = \{\mathfrak{p} \in *\text{Spec}(R) \mid I \subseteq \mathfrak{p}\} = V(I) \cap *\text{Spec}(R).$$

The *\*Krull dimension* of  $R$  is

$$*\dim(R) = \sup\{n \geq 0 \mid \exists \text{ a chain } \mathfrak{p}_0 \subsetneq \mathfrak{p}_1 \subsetneq \cdots \subsetneq \mathfrak{p}_n \text{ in } *\text{Spec}(R)\}.$$

The *\*Krull dimension* of  $R/I$  can be computed as

$$*\dim(R/I) = \sup\{n \geq 0 \mid \exists \text{ a chain } \mathfrak{p}_0 \subsetneq \mathfrak{p}_1 \subsetneq \cdots \subsetneq \mathfrak{p}_n \text{ in } *V(I)\}.$$

**Definition 2.6.10.** [1, Definition 1.5.13] Let  $R$  be a graded ring. A homogeneous ideal  $\mathfrak{m}$  of  $R$  is called *\*maximal* if every homogeneous ideal that properly contains  $\mathfrak{m}$  equals  $R$ . The ring  $R$  is called *\*local* if it has a unique *\*maximal* ideal  $\mathfrak{m}$ . A *\*local* ring with *\*maximal* ideal  $\mathfrak{m}$  will be denoted by  $(R, \mathfrak{m})$ .

**Remark.** With respect to its finitely generated graded  $R$ -modules, a *\*local* ring  $(R, \mathfrak{m})$  behaves like a local ring.

## 2.7 Graded Cohen-Macaulay Rings

Let  $A$  be a field, set  $R = A[X_1, \dots, X_d]$  and  $\mathfrak{X} = (X_1, \dots, X_d)R$  and let  $I \subsetneq R$  be an ideal generated by homogeneous polynomials. In this section, we define Cohen-Macaulayness and see how to compute the type of  $R/I$ , when  $R/I$  is Cohen-Macaulay.

**Remark.** The graded ring  $(R, \mathfrak{X})$  with the natural grading is a *\*local* ring, where  $\mathfrak{X} = \bigoplus_{i \geq 1} R_i$ , is called the *irrelevant ideal* of  $R$ .

We have already defined depth and type in the local setting. Now we define them in the *\*local* setting. See Fact 2.7.2 for a comparison.

**Definition 2.7.1.** The *\*depth* of  $R/I$  is

$$*\text{depth}(R/I) = \text{the length of a maximal homogeneous } R/I\text{-regular sequence in } \mathfrak{X}.$$

The *type* of  $R/I$  is

$$r_R(R/I) = \dim_A(*\text{Ext}_R^n(A, R/I)) = \dim_A(\text{Ext}_R^n(A, R/I)),$$

where  $n = *\text{depth}(R/I)$ .

**Fact 2.7.2.** [1, Theorem 1.5.8 and Proposition 1.5.15] The polynomial ring  $R$  is Noetherian and  $R/I$  is a finitely generated graded  $R$ -module. We have

$$*\text{depth}(R/I) = \text{depth}(R/I),$$

$$*\text{dim}(R/I) = \text{dim}(R/I).$$

From Fact 2.5.5 and 2.7.2, we get the following fact directly.

**Fact 2.7.3.** [1, Theorem 1.2.10] If  $f_1, \dots, f_r \in \mathfrak{X}$  is a homogeneous  $R/I$ -regular sequence, then

$$*\text{dim}(R/(I + (f_1, \dots, f_r)R)) = *\text{dim}(R/I) - r,$$

$$*\text{depth}(R/(I + (f_1, \dots, f_r)R)) = *\text{depth}(R/I) - r.$$

For the rest of the dissertation, in light of Fact 2.7.2, we will not write  $*$  for notations used in  $*$ local ring.

Cohen-Macaulay rings, defined next in the  $*$ local setting, have been shown in the literature to be extremely nice. See the discussion in [1, p.57] for more about this.

**Definition 2.7.4.** The quotient  $R/I$  is *Cohen-Macaulay* if  $\text{depth}(R/I) = \text{dim}(R/I)$ .

**Remark.** We can either regard the quotient  $R/I$  as an  $R$ -module, or regard  $(R/I, \mathfrak{X}/I)$  as a local ring with the residue field  $(R/I)/(\mathfrak{X}/I) \cong A$ . So Definition 2.7.4 can be deduced from Definition 2.5.7.

**Definition 2.7.5.** We say that  $I$  is *Cohen-Macaulay* if the quotient  $R/I$  is Cohen-Macaulay.

**Fact 2.7.6.** [1, Lemma 3.1.16] If  $R/I$  is Cohen-Macaulay and  $f_1, \dots, f_n \in \mathfrak{X}$  is a homogeneous  $R/I$ -regular sequence, then with  $S = R/(f_1, \dots, f_n)$ , we have that

$$r_R(R/I) = r_S(R/(I + (f_1, \dots, f_n))),$$

**Fact 2.7.7.** [14, Fact 2.93(b)] If  $I$  is a monomial ideal and has an irredundant parametric decomposition  $I = \bigcap_{i=1}^t Q_i$ , then  $r_R(R/I) = t$ .

**Fact 2.7.8.** [9, Theorem 5.3.16] Let  $I$  be a monomial ideal. If  $R/I$  is Cohen-Macaulay, then  $I$  is unmixed.

In practice, when we compute the Cohen-Macaulay type of  $R/I$ , we will try to find a maximal homogeneous  $R/I$ -regular sequence  $f_1, \dots, f_n$  with  $n = \text{depth}(R/I) = \dim(R/I)$ , such that  $R/(I + (f_1, \dots, f_n))$  has dimension 0 by Fact 2.5.5. We can usually simplify  $R/(I + (f_1, \dots, f_n))$  as, say  $S/J$ . Since  $A$  is a field and  $\dim(S/J) = 0$ , we have that  $J$  has an irredundant parametric decomposition by Fact 2.2.37. Thus, we utilize Fact 2.7.7 to compute the type of  $S/J$ . Finally, Fact 2.7.6 tells us it is also the type of  $R/I$ .

**Example 2.7.9.** Consider the monomial ideal

$$I = (X_1X_2, X_2X_3, X_3X_4)R = (X_1, X_3)R \cap (X_2, X_3)R \cap (X_2, X_4)R$$

in  $R = A[X_1, X_2, X_3, X_4]$ . One can check that  $\dim(R/I) = 2$  and that  $X_1 - X_2, X_3 - X_4$  is an  $R/I$ -regular sequence. Thus,  $R/I$  is Cohen-Macaulay. Note that

$$R/(I + (X_1 - X_2, X_3 - X_4)R) \cong S/(X_2^2, X_2X_3, X_3^2)S,$$

where  $S = A[X_1, X_2]$ . We have an irredundant parametric decomposition  $(X_2^2, X_2X_3, X_3^2)S = (X_2, X_3^2)S \cap (X_2^2, X_3)S$ . So by Facts 2.7.3 and 2.7.7, we have

$$\begin{aligned} r_R(R/I) &= r_R(R/(I + (X_1 - X_2, X_3 - X_4)R)) \\ &= r_S(S/(X_2^2, X_2X_3, X_3^2)S) \\ &= 2. \end{aligned}$$

## Chapter 3

# Cohen-Macaulayness of $f$ -Weighted $r$ -Path Ideals

Let  $\mathbb{K}$  be a field,  $d \geq 2$ ,  $R = \mathbb{K}[X_1, \dots, X_d]$  and  $\mathfrak{m} = (X_1, \dots, X_d)R$ . Let  $G = (V, E)$  be a (finite simple) graph with vertex set  $V = \{v_1, \dots, v_d\}$  and edge set  $E$ . Let  $r \geq 2$  be a positive integer and  $R' = \mathbb{K}[\{X_{i,j} \mid i = 1, \dots, d, j = 0, \dots, r\}]$ . Let  $f : \mathbb{N} \times \mathbb{N} \rightarrow \mathbb{N}$  be such that  $f(a, b) = f(b, a)$  for all  $a, b \in \mathbb{N}$ . For example,  $f$  may be max, min, gcd, or lcm, etc.

In this chapter, we classify all weighted  $r$ -path suspensions  $G'_{\omega'}$  (see Definition 3.1.16) for which the  $f$ -weighted  $r$ -path ideal of  $G'_{\omega'}$  (see Definition 3.1.2) is Cohen-Macaulay. In particular, we classify all weighted trees for which the  $f$ -weighted  $r$ -path ideal is Cohen-Macaulay. These results are in Theorems 3.5.5 and 3.5.6.

### 3.1 Background

In this section, we give some background information needed for classifying Cohen-Macaulay weighted  $r$ -path suspensions.

We first list the definitions for paths and cycles from Diestel [4].

**Definition 3.1.1.** An  $r$ -path in  $G$  is a non-empty graph  $P = (V', E')$  of the form  $V' = \{x_1, \dots, x_{r+1}\}$  and  $E' = \{x_1x_2, x_2x_3, \dots, x_rx_{r+1}\}$ , where  $x_i$  are all distinct. We denote an  $r$ -path by  $P_r = (x_1 \text{ --- } x_2 \text{ --- } \dots \text{ --- } x_{r+1})$  or  $x_1 \dots x_{r+1}$  for simplicity. Note that there are  $r+1$  vertices

and  $r$  edges in  $P_r$ .

If  $P_r = (x_1 \text{ --- } x_2 \text{ --- } \cdots \text{ --- } x_r)$  is an  $(r-1)$ -path, then the graph  $C_r := P_{r-1} + x_r x_1$  is called an  $r$ -cycle. Note that there are  $r$  vertices and  $r$  edges in  $C_r$ .

**Definition 3.1.2.** We have the following definitions:

(a) [7, Definition 2.1] The  $f$ -weighted  $r$ -path ideal associated to  $G_\omega$  is the ideal  $I_{r,f}(G_\omega) \subseteq R$  that is “generated by the  $f$ -weighted paths in  $G$  of length  $r$ ”:

$$I_{r,f}(G_\omega) = \left( \begin{array}{l} X_{i_1}^{e_{i_1}} \cdots X_{i_{r+1}}^{e_{i_{r+1}}} \\ \left. \begin{array}{l} v_{i_1} \cdots v_{i_{r+1}} \text{ is a path in } G \text{ with } e_{i_1} = \omega(v_{i_1} v_{i_2}), \\ e_{i_j} = f(\omega(v_{i_{j-1}} v_{i_j}), \omega(v_{i_j} v_{i_{j+1}})) \text{ for } 1 < j \leq r \\ \text{and } e_{i_{r+1}} = \omega(v_{i_r} v_{i_{r+1}}) \end{array} \right\} \end{array} \right) R.$$

(b) [7, Definition 2.5] For  $V' \subseteq V$  and  $\delta' : V' \rightarrow \mathbb{N}$ , we write

$$P(V', \delta') = \left( X_i^{\delta'(v_i)} \mid v_i \in V' \right) R.$$

**Remark.** When  $f = \max$ , we write that  $I_r(G_\omega) := I_{r,\max}(G_\omega)$ , which is the *weighted  $r$ -path ideal* associated to  $G_\omega$ .

**Definition 3.1.3.** [7, Definition 1.5] An  $f$ -weighted  $r$ -path vertex cover of  $G_\omega$  is an ordered pair  $(V', \delta')$  with  $V' \subseteq V$  and  $\delta' : V' \rightarrow \mathbb{N}$  such that  $V'$  is an  $r$ -path vertex cover of  $G$  and such that for any  $r$ -path  $P_r := v_{i_1} \cdots v_{i_{r+1}}$  in  $G$  at least one of the following holds:

- (a)  $\delta'(v_{i_1}) \leq \omega(v_{i_1} v_{i_2})$ ;
- (b)  $\delta'(v_{i_{r+1}}) \leq \omega(v_{i_r} v_{i_{r+1}})$ ; or
- (c)  $\delta'(v_{i_j}) \leq f\{\omega(v_{i_{j-1}} v_{i_j}), \omega(v_{i_j} v_{i_{j+1}})\}$  for some  $j \in \{2, \dots, r\}$ .

The number  $\delta'(v_i)$  is the *weight* of  $v_i$ . We say that a vertex  $v_i \in V'$  *weighted-covers* the  $r$ -path  $P_r$  with respect to  $(V', \delta')$  if  $v_i$  satisfies one of the 3 conditions above.

**Remark.** When  $f = \max$ , we write that  $(V', \delta')$  is a *weighted  $r$ -path vertex cover* of  $G_\omega$ .

**Notation 3.1.4.** For an  $f$ -weighted  $r$ -path vertex cover  $(V', \delta')$  of  $G_\omega$ , we also use  $\{v_i^{\delta'(v_i)} \mid v_i \in V'\}$  to denote it, especially when we depict an  $f$ -weighted  $r$ -path vertex cover of  $G_\omega$  in sketches.



**Definition 3.1.5.** [7, Definition 1.7] Given two  $f$ -weighted  $r$ -path vertex covers  $(V'_1, \delta'_1)$  and  $(V'_2, \delta'_2)$  of  $G_\omega$ , we write  $(V'_2, \delta'_2) \leq (V'_1, \delta'_1)$  if  $V'_2 \subseteq V'_1$  and  $\delta'_2(v_i) \geq \delta'_1(v_i)$  for all  $v_i \in V'_2$ . An  $f$ -weighted  $r$ -path vertex cover  $(V', \delta')$  is *minimal* if there does not exist another  $f$ -weighted  $r$ -path vertex cover  $(V'', \delta'')$  such that  $(V'', \delta'') < (V', \delta')$ .

**Fact 3.1.6.** [7, Lemma 1.11] For every  $f$ -weighted  $r$ -path vertex cover  $(V', \delta')$  of  $G_\omega$ , there is a minimal  $f$ -weighted  $r$ -path vertex cover  $(V'', \delta'')$  of  $G_\omega$  such that  $(V'', \delta'') \leq (V', \delta')$ .

**Fact 3.1.7.** [7, Theorem 2.7] The  $f$ -weighted  $r$ -path ideal  $I_{r,f}(G_\omega)$  has the following decomposition:

$$I_{r,f}(G_\omega) = \bigcap_{(V', \delta') \text{ } f\text{-w. } r\text{-path v. cover}} P(V', \delta') = \bigcap_{(V', \delta') \text{ min. } f\text{-w. } r\text{-path v. cover}} P(V', \delta'),$$

where the first intersection is taken over all  $f$ -weighted  $r$ -path vertex covers of  $G_\omega$ , and the second intersection is taken over all minimal  $f$ -weighted  $r$ -path vertex covers of  $G_\omega$ . The second intersection is irredundant.

**Remark.** The second decomposition of  $I_{r,f}(G_\omega)$  is much more intensive than the first one.

**Fact 3.1.8.** [7, Lemma 2.11] If  $I_{r,f}(G_\omega)$  is unmixed, then  $I_r(G)$  is also unmixed.

**Definition 3.1.9.** [7, Definition 3.1] Let  $v_i$  be a vertex of degree 1 in  $G$  that is not a part of any  $r$ -path in  $G$ . We write that  $v_i$  is an  *$r$ -pathless leaf* of  $G_\omega$ . Let  $H_\lambda$  be the subgraph of  $G_\omega$  induced by the vertex subset  $V \setminus \{v_i\}$ . We write that  $H_\lambda$  is obtained by *pruning* an  $r$ -pathless leaf from  $G_\omega$ . A subgraph  $\Gamma_{\lambda'}$  of  $G_\omega$  is obtained by *pruning a sequence of  $r$ -pathless leaves* from  $G_\omega$  if there exists a sequence of graphs  $G_\omega = G_{\omega^{(0)}}, G_{\omega^{(1)}}, \dots, G_{\omega^{(l)}} = \Gamma_{\lambda'}$  such that each  $G_{\omega^{(i+1)}}$  is obtained by pruning an  $r$ -pathless leaf from  $G_{\omega^{(i)}}$ .

**Fact 3.1.10.** [7, Lemma 3.3] Let  $H_\lambda$  be a weighted graph obtained by pruning a single  $r$ -pathless leaf  $v_i$  from  $G_\omega$ .

- (a) The set of  $r$ -paths in  $G$  is the same as the set of  $r$ -paths in  $H$ .
- (b) The minimal  $f$ -weighted  $r$ -path vertex covers of  $G_\omega$  are the same as the minimal  $f$ -weighted  $r$ -path vertex covers of  $H_\lambda$ .

**Lemma 3.1.11.** Let  $H_\lambda$  be a weighted graph obtained by pruning a sequence of  $r$ -pathless leaves from  $G_\omega$ .

(a) The ideals  $I_{r,f}(G_\omega)$  and  $I_{r,f}(H_\lambda)$  have the same generators.

(b) The ideal  $I_{r,f}(G_\omega)$  is unmixed if and only if  $I_{r,f}(H_\lambda)$  is so.

(c) The ideal  $I_{r,f}(G_\omega)$  is Cohen-Macaulay if and only if  $I_{r,f}(H_\lambda)$  is so.

*Proof.* (a) By Fact 3.1.10(a), the set of  $r$ -paths in  $G$  is the same as the set of  $r$ -paths in  $H$  and  $\lambda(e) = \omega(e)$  for each edge  $e \in E(H) \subseteq E(G)$ . Then the claim about the generators now follows directly.

(b) It follows from Theorem 3.1.7 and Lemma 3.1.10(b).

(c) Part (a) implies  $(S'/I_{r,f}(H_\lambda))[X] \cong R/I_{r,f}(G_\omega)$ , where  $S' = \mathbb{K}[X_1, \dots, X_{i-1}, X_{i+1}, \dots, X_d]$ . It follows that  $R/I_{r,f}(G_\omega)$  is Cohen-Macaulay if and only if  $S'/I_{r,f}(H_\lambda)$  is so.  $\square$

**Definition 3.1.12.** The *suspension* of  $G$  is the graph  $\Sigma G$  with vertex set

$$V(\Sigma G) = V \sqcup \{w_1, \dots, w_d\} = \{v_1, \dots, v_d, w_1, \dots, w_d\}$$

and edge set

$$E(\Sigma G) = E(G) \sqcup \{v_1 w_1, \dots, v_d w_d\}.$$

This is also known as the  $K_1$ -corona of  $G$ .

**Remark.** The term ‘‘suspension’’ is due to Villarreal [13]. It is not related to the suspension of a topological space.

**Example 3.1.13.** The suspension  $\Sigma P_2$  of the 2-path  $G = P_2 = (v_1 \text{ --- } v_2 \text{ --- } v_3)$  is

$$\begin{array}{ccccc} w_1 & & w_2 & & w_3 \\ | & & | & & | \\ v_1 & \text{---} & v_2 & \text{---} & v_3. \end{array}$$

**Definition 3.1.14.** The  $r$ -path suspension of  $G$  is the graph  $\Sigma_r G$  obtained by adding a new path of length  $r$  to each vertex of  $G$  such that the vertex set is

$$V(\Sigma_r G) = \{v_{i,j} \mid i = 1, \dots, d, j = 0, \dots, r\} \text{ with } v_{i,0} = v_i, \forall i = 1, \dots, d.$$

The new  $r$ -paths are called  $r$ -whiskers.

**Example 3.1.15.** The 2-path suspension  $\Sigma_2 P_2$  of the 2-path  $G = P_2 = (v_1 \text{ --- } v_2 \text{ --- } v_3)$

is

$$\begin{array}{ccccc} v_1 & \text{---} & v_{1,1} & \text{---} & v_{1,2} \\ | & & & & \\ v_2 & \text{---} & v_{2,1} & \text{---} & v_{2,2} \\ | & & & & \\ v_3 & \text{---} & v_{3,1} & \text{---} & v_{3,2}. \end{array}$$

We will classify all the weighted trees  $H_\mu$  such that  $I_{r,f}(H_\mu)$  is Cohen-Macaulay in terms of the weighted  $r$ -path suspension, define below.

**Definition 3.1.16.** [7, Definition 3.4] A *weighted  $r$ -path suspension* of  $G_\omega$  is a weighted graph  $(\Sigma_r G)_\lambda$  with weight function  $\lambda : \Sigma_r G \rightarrow \mathbb{N}$  such that the underlying graph  $\Sigma_r G$  is an  $r$ -path suspension of  $G$  and  $\lambda(v_i v_j) = \omega(v_i v_j)$  for all  $v_i v_j \in E(G)$ , i.e.,  $\lambda|_{E(G)} = \omega$ .

**Remark.** If  $r = 1$ , then  $(\Sigma_1 G)_\lambda = (\Sigma G)_\lambda$  is a *weighted suspension* of  $G_\omega$  [10, Definition 5.6].

**Example 3.1.17.** A weighted 2-path suspension  $(\Sigma_2 P_2)_\lambda$  of

$$G_\omega := (P_2)_\omega = (v_1 \overset{1}{\text{---}} v_2 \overset{2}{\text{---}} v_3)$$

is

$$\begin{array}{ccccc} v_1 & \overset{4}{\text{---}} & v_{1,1} & \overset{3}{\text{---}} & v_{1,2} \\ | & & & & \\ 1 & & & & \\ v_2 & \overset{3}{\text{---}} & v_{2,1} & \overset{3}{\text{---}} & v_{2,2} \\ | & & & & \\ 2 & & & & \\ v_3 & \overset{2}{\text{---}} & v_{3,1} & \overset{5}{\text{---}} & v_{3,2}. \end{array}$$

Based on the convention that  $v_{i,0} = v_i$  for  $i = 1, \dots, d$ , we have that  $X_{i,0} = X_i$  for  $i = 1, \dots, d$ .

**Definition 3.1.18.** Define a ring homomorphism  $p$  by

$$\begin{aligned} p : R' &\longrightarrow R \\ a &\longrightarrow a, \forall a \in \mathbb{K}, \\ X_{ij} &\longmapsto X_i \forall i = 1, \dots, d, j = 0, \dots, r. \end{aligned}$$

One can think of  $p$  as a “projection”.

**Remark.** Let  $I \subseteq R'$  be a monomial ideal and set

$$IR = p(I)R = (X_{i_1}^{a_1} \cdots X_{i_n}^{a_n} \in R \mid \exists X_{i_1, j_1}^{a_1} \cdots X_{i_n, j_n}^{a_n} \in \llbracket I \rrbracket)R.$$

In words,  $IR$  is the monomial ideal of  $R$  obtained from  $I$  by setting  $X_{i,j} = X_i$  for all  $i, j$ . It is straightforward to show that if  $f_1, \dots, f_m$  is a monomial generating sequence for  $I$ , then  $p(f_1), \dots, p(f_m)$  is a monomial generating sequence for  $IR$ .

**Example 3.1.19.** Let  $I = (X_{1,1}X_{1,2}^2X_{1,3}^3, X_{1,0}^4X_{2,0}X_{3,0}^2)R'$  be an ideal of the polynomial ring  $R' = \mathbb{K}[\{X_{i,j} \mid i = 1, \dots, 3, j = 0, \dots, 3\}]$ . Then

$$IR = (X_1X_1^2X_1^3, X_1^4X_2X_3^2)R = (X_1^6, X_1^4X_2X_3^2)R.$$

In Section 3.2, we will prove that if  $I = I_{r,f}((\Sigma_r G)_\lambda)$  for some weighted  $r$ -path suspension  $(\Sigma_r G)_\lambda$ , then in an irredundant  $m$ -irreducible decomposition of  $p_{\underline{n}}(I)$  with  $\underline{n} \in \mathbb{N}^d$ , variables in each component have different first indexes when certain conditions for  $r, f$  and  $\lambda$  are satisfied. This result then will be used in finding regular sequences for  $R'/I$  in Theorem 3.4.1 and be used in Propositions 3.2.1, 3.2.43, and 3.2.44 to prove that  $I = I_{r,f}((\Sigma_r G)_\lambda)$  is unmixed.

**Definition 3.1.20.** Let  $\underline{n} = (n_1, \dots, n_d) \in \mathbb{N}^d$ . Define a ring homomorphism  $p_{\underline{n}}$  by

$$\begin{aligned} p_{\underline{n}} : R' &\longrightarrow A[X_{1,0}, \dots, X_{1, \min\{n_1-1, r\}}, \dots, X_{d,0}, \dots, X_{d, \min\{n_d-1, r\}}] =: S \\ a &\longmapsto a, \quad \forall a \in A, \\ X_{i,j} &\longmapsto X_{i, n_i-1}, \quad \forall i = 1, \dots, d, \quad j = n_i, \dots, r. \end{aligned}$$

Let  $I \subseteq R'$  be a monomial ideal. Then  $p_{\underline{n}}(I)S$  is the monomial ideal of  $S$  obtained from  $I$  by setting  $X_{i,j} = X_{i, n_i-1}$  for any  $X_{i,j} \in I$  such that  $n_i \leq j \leq r$ . It is straightforward to show that if  $f_1, \dots, f_m$  is a monomial generating sequence for  $I$ , then  $p_{\underline{n}}(f_1), \dots, p_{\underline{n}}(f_m)$  is a monomial generating sequence for  $p_{\underline{n}}(I)S$ .

**Remark.** (a) Let  $\underline{1} = (1, \dots, 1) \in \mathbb{N}^d$ , then  $p_{\underline{1}} = p$ , where  $p$  is from Definition 3.1.18.

(b) If  $\underline{n} = (n_1, \dots, n_d) \in \mathbb{N}^d$  such that  $n_1, \dots, n_d > r$ , then  $S = R'$  and  $p_{\underline{n}}(I)S = I$  for any monomial ideal  $I \subseteq R'$ .

**Example 3.1.21.** Consider the following graph  $(\Sigma_2 P_2)_\lambda$  with  $G_\omega := (P_2)_\omega = (v_1 \xrightarrow{1} v_2 \xrightarrow{2} v_3)$ .

$$\begin{array}{ccccc} v_1 & \xrightarrow{4} & v_{1,1} & \xrightarrow{3} & v_{1,2} \\ | & & & & \\ 1 & & & & \\ v_2 & \xrightarrow{3} & v_{2,1} & \xrightarrow{3} & v_{2,2} \\ | & & & & \\ 2 & & & & \\ v_3 & \xrightarrow{2} & v_{3,1} & \xrightarrow{5} & v_{3,2} \end{array}$$

Let

$$\begin{aligned} I := I_{2,\min}((\Sigma_2 P_2)_\lambda) &= (X_{1,2}^3 X_{1,1}^3 X_1^4, X_{1,1}^4 X_1 X_2, X_1 X_2 X_{2,1}^3, X_1 X_2 X_3^2, X_{2,2}^3 X_{2,1}^3 X_2^3, \\ &X_{2,1}^3 X_2^2 X_3^2, X_2^2 X_3^2 X_{3,1}^2, X_{3,2}^5 X_{3,1}^2 X_3^2) R'. \end{aligned}$$

Let  $\underline{n} = (2, 3, 1) \in \mathbb{N}^3$ . Then  $S = R[X_{1,0}, X_{1,1}, X_{2,0}, X_{2,1}, X_{2,2}, X_{3,0}]$  and setting  $X_{1,2} = X_{1,1}$ ,  $X_{3,1} = X_3$ , and  $X_{3,2} = X_3$  in  $I$  we have

$$\begin{aligned} p_{\underline{n}}(I)S &= (X_{1,1}^3 X_{1,1}^3 X_1^4, X_{1,1}^4 X_1 X_2, X_1 X_2 X_{2,1}^3, X_1 X_2 X_3^2, X_{2,2}^3 X_{2,1}^3 X_2^3, \\ &X_{2,1}^3 X_2^2 X_3^2, X_2^2 X_3^2 X_3^2, X_3^5 X_3^2 X_3^2) R' \\ &= (X_{1,1}^6 X_1^4, X_{1,1}^4 X_1 X_2, X_1 X_2 X_{2,1}^3, X_1 X_2 X_3^2, X_{2,2}^3 X_{2,1}^3 X_2^3, \\ &X_{2,1}^3 X_2^2 X_3^2, X_2^2 X_3^4, X_3^9) R'. \end{aligned}$$

**Definition 3.1.22.** Let  $(\Sigma_r G)_\lambda$  be a weighted  $r$ -suspension of  $G_\omega$ ,  $I := I_{r,f}((\Sigma_r G)_\lambda)$ ,  $\underline{n} \in \mathbb{N}^d$  and  $P_r$  an  $r$ -path in  $(\Sigma_r G)_\lambda$  with the corresponding generator  $\underline{X}^\alpha$  in  $I$ . We write

$$P_r \xrightarrow{\underline{n}} v_{i_1, j_1} \cdots v_{i_m, j_m} =: \wp$$

if the reduction is  $\text{red}(p_{\underline{n}}(\underline{X}^\alpha)) = X_{i_1, j_1} \cdots X_{i_m, j_m}$ . We call that  $\wp$  is a *path* in  $p_{\underline{n}}(I)$ .

**Remark.** If  $\underline{n}$  is known from context, we usually write  $P_r \rightsquigarrow \wp$  instead of  $P_r \xrightarrow{\underline{n}} \wp$ .

**Example 3.1.23.** In Example 3.1.21,  $P_2 := v_{1,2} v_{1,1} v_{1,0} \xrightarrow{\underline{n}} v_{1,1} v_{1,0} =: \wp$  since  $X_{1,2}^3 X_{1,1}^3 X_{1,0}^4$  is the corresponding generator of  $P_r$  in  $I$  and  $\text{red}(p_{\underline{n}}(X_{1,2}^3 X_{1,1}^3 X_{1,0}^4)) = \text{red}(X_{1,1}^3 X_{1,1}^3 X_{1,0}^4) = X_{1,1} X_{1,0}$ .

**Definition 3.1.24.** Let  $(\Sigma_r G)_\lambda$  be a weighted  $r$ -suspension of  $G_\omega$ ,  $I := I_{r,f}((\Sigma_r G)_\lambda)$ ,  $\underline{n} \in \mathbb{N}^d$ ,  $P_r$  an  $r$ -path in  $(\Sigma_r G)_\lambda$  with the corresponding generator  $\underline{X}^\alpha$  in  $I$  and  $P_r \xrightarrow{\underline{n}} \wp$ . Let  $\mathfrak{P} := (V'', \delta'')$  be

such that  $V'' \subseteq V((\Sigma_r G)_\lambda)$  and  $\delta'' : V'' \rightarrow \mathbb{N}$ . Denote  $v_{i,j} \smile (P_r \xrightarrow{\underline{n}} \wp, \mathfrak{P})$  if  $v_{i,j} \in V'' \cap V(\wp)$  and  $X_{i,j}^{\delta''(v_{i,j})} \mid p_{\underline{n}}(\underline{X}^\alpha)$  and denote  $v_{i,j} \not\smile (P_r \xrightarrow{\underline{n}} \wp, \mathfrak{P})$  otherwise. In particular, if  $P_r = \wp$ , then denote  $v_{i,j} \smile (\wp, \mathfrak{P})$  or  $v_{i,j} \not\smile (\wp, \mathfrak{P})$  if  $v_{i,j} \in V'' \cap V(\wp)$  and  $X_{i,j}^{\delta''(v_{i,j})} \mid p_{\underline{n}}(\underline{X}^\alpha)$ .

**Remark.** If  $\underline{n}$  and  $\mathfrak{P}$  are known from context, we write  $v_{i,j} \smile (P_r \rightsquigarrow \wp)$  or  $v_{i,j} \not\smile (P_r \rightsquigarrow \wp)$ . In particular, if  $P_r = \wp$ , then write  $v_{i,j} \smile \wp$  or  $v_{i,j} \not\smile \wp$ .

**Example 3.1.25.** A weighted suspension  $(\Sigma G)_\lambda$  of  $G_\omega := (P_1)_\omega = (v_1 \xrightarrow{1} v_2)$  is

$$\begin{array}{ccc} v_{1,1} & & v_{2,1} \\ \left| \begin{array}{c} 2 \\ \end{array} \right. & & \left| \begin{array}{c} 3 \\ \end{array} \right. \\ v_1 & \xrightarrow{1} & v_2. \end{array}$$

Let  $I := I_{2,\min}((\Sigma P_1)_\lambda)$  and  $\underline{n} := (1,1)$ . Then  $p_{\underline{n}}(I)$  is obtained from  $I$  by setting  $X_{1,1} = X_{1,0}$  and  $X_{2,1} = X_{2,0}$  in  $I$ . We have that  $P_2 := v_{1,1}v_1v_2 \xrightarrow{\underline{n}} v_1v_2$ . Let  $\underline{X}^\alpha := X_{1,1}^2X_{1,0}X_{2,0}$  be the corresponding generator of  $v_{1,1}v_1v_2$  in  $I$ . Then  $p_{\underline{n}}(\underline{X}^\alpha) = X_{1,0}^3X_{2,0}$ . Let  $\mathfrak{P} = \{v_{1,0}^2, v_{2,0}^2, v_{1,1}\}$ . Then  $v_{1,0} \smile (v_{1,1}v_{1,0}v_{2,0} \rightsquigarrow v_{1,0}v_{2,0}, \mathfrak{P})$  since  $X_{1,0}^2 \mid X_{1,0}^3X_{2,0}$ ,  $v_{2,0} \not\smile (v_{1,1}v_{1,0}v_{2,0} \rightsquigarrow v_{1,0}v_{2,0}, \mathfrak{P})$  since  $X_{2,0}^2 \nmid X_{1,0}^3X_{2,0}$ ,  $v_{1,1} \not\smile (v_{1,1}v_{1,0}v_{2,0} \rightsquigarrow v_{1,0}v_{2,0}, \mathfrak{P})$  since  $v_{1,1} \notin \{v_{1,0}, v_{2,0}\}$ .

**Lemma 3.1.26.** Let  $(\Sigma_r G)_\lambda$  be a weighted  $r$ -suspension of  $G_\omega$ ,  $I := I_{r,f}((\Sigma_r G)_\lambda)$ , and  $\underline{n} \in \mathbb{N}^d$ . Let  $\mathfrak{P} := (V'', \delta'')$  with  $V'' \subseteq V((\Sigma_r G)_\lambda)$  and  $\delta'' : V'' \rightarrow \mathbb{N}$  be such that  $p_{\underline{n}}(I) \subseteq P(V'', \delta'')$ . Then for any path  $\wp$  in  $p_{\underline{n}}(I)$  such that  $P_r \rightsquigarrow \wp$ , we have that  $v_{k,l} \smile (P_r \rightsquigarrow \wp)$  for some  $v_{k,l} \in V''$ .

*Proof.* Assume that  $\wp := v_{i_1, j_1} \dots v_{i_m, j_m}$  and  $\underline{X}^\alpha$  is the corresponding generator of the  $r$ -path  $P_r$  in  $I$ . Then  $\text{red}(p_{\underline{n}}(\underline{X}^\alpha)) = X_{i_1, j_1} \dots X_{i_m, j_m}$  and  $p_{\underline{n}}(\underline{X}^\alpha) \in p_{\underline{n}}(I) \subseteq P(V'', \delta'')$ . So there exists some  $v_{k,l} \in V''$  such that  $v_{k,l} \in V(\wp)$  and  $X_{k,l}^{\delta''(v_{k,l})} \mid p_{\underline{n}}(\underline{X}^\alpha)$ . Hence  $v_{k,l} \smile (P_r \rightsquigarrow \wp)$ .  $\square$

**Remark.** One can think of  $p_{\underline{n}}(\underline{X}^\alpha)$  as the corresponding generator of  $(P_r \rightsquigarrow \wp)$ .

**Definition 3.1.27.** Let  $(\Sigma_r G)_\lambda$  be a weighted  $r$ -suspension of  $G_\omega$ ,  $I := I_{r,f}((\Sigma_r G)_\lambda)$ , and  $\underline{n} \in \mathbb{N}^d$ . Let  $\mathfrak{P} := (V'', \delta'')$  be such that  $V'' \subseteq V((\Sigma_r G)_\lambda)$  and  $\delta'' : V'' \rightarrow \mathbb{N}$ . For  $v_{i,j} \in V''$ , set

$$\mathfrak{P}_{i,j}(p_{\underline{n}}(I)) := \{P_r \xrightarrow{\underline{n}} \wp \mid v_{i,j} \smile (P_r \rightsquigarrow \wp) \text{ but } v_{k,l} \not\smile (P_r \rightsquigarrow \wp) \forall v_{k,l} \in V'' \setminus \{v_{i,j}\}\}.$$

If  $(P_r \rightsquigarrow \wp) \in \mathfrak{P}_{i,j}(p_{\underline{n}}(I))$  such that  $P_r = \wp$ , then we write  $P_r \in \mathfrak{P}_{i,j}(p_{\underline{n}}(I))$ .

**Remark.** If  $p_{\underline{n}}(I)$  is known from context, we usually write  $\mathfrak{P}_{i,j}$  instead of  $\mathfrak{P}_{i,j}(p_{\underline{n}}(I))$ . If  $P_r \rightsquigarrow \emptyset$  is such that  $P_r = \emptyset$ , we simplify  $P_r \rightsquigarrow \emptyset$  as  $P_r$ . For example,

$$\mathfrak{P}_{i,j}(I) = \{P_r \mid P_r \text{ an } r\text{-path in } (\Sigma_r G)_\lambda \text{ such that } v_{i,j} \smile P_r \text{ but } v_{k,l} \not\smile P_r \forall v_{k,l} \in V'' \setminus \{v_{i,j}\}\}.$$

$\mathfrak{P}_{i,j}(I)$  is a set of  $r$ -paths in  $(\Sigma_r G)_\lambda$  that is uniquely “weighted covered” by  $v_{i,j}$  when considering the “covering set”  $\mathfrak{P} = (V'', \delta'')$ . That’s to say, when  $\mathfrak{P}_{i,j}(I) \neq \emptyset$ , for  $P_r$  in  $\mathfrak{P}_{i,j}(I)$ , we have that  $v_{i,j} \in V''$  satisfies one of the constraints in Definition 3.1.3 and other vertices in  $V''$  don’t.

For  $v_{i,j} \in V''$ , we say that  $v_{i,j}$  “weighted cover”  $(P_r \xrightarrow{\underline{n}} \emptyset)$ , notationally,  $v_{i,j} \smile (P_r \xrightarrow{\underline{n}} \emptyset)$ , if  $v_{i,j} \in V(\emptyset)$  and  $X_{i,j}^{\delta''(v_{i,j})} \mid p_{\underline{n}}(\underline{X}^\alpha)$ , where  $\underline{X}^\alpha$  is the corresponding generators of  $P_r$  in  $I$ . Then one can mimic the interpretation of  $\mathfrak{P}_{i,j}(I)$  to understand  $\mathfrak{P}_{i,j}(p_{\underline{n}}(\underline{X}^\alpha))$ .

**Example 3.1.28.** In Example 3.1.25, we have that  $(v_{1,1}v_{1,0}v_{2,0} \rightsquigarrow v_{1,0}v_{2,0}) \in \mathfrak{P}_{1,0}$ . Let  $\underline{X}^\beta := X_{1,0}X_{2,0}X_{2,1}^3$  be the corresponding generator of  $v_{1,0}v_{2,0}v_{2,1}$  in  $I$ . Then  $p_{\underline{n}}(\underline{X}^\beta) = X_{1,0}X_{2,0}^4$ . We have that  $v_{2,0} \smile (v_{1,0}v_{2,0}v_{2,1} \rightsquigarrow v_{1,0}v_{2,0})$  since  $X_{2,0}^2 \mid X_{1,0}X_{2,0}^4$ . Then  $(v_{1,0}v_{2,0}v_{2,1} \rightsquigarrow v_{1,0}v_{2,0}) \notin \mathfrak{P}_{1,0}$ . Also, for a fixed  $\underline{n}$ , there is no other  $P_3 \rightsquigarrow \emptyset$ , therefore,  $\mathfrak{P}_{1,0} = \{v_{1,1}v_{1,0}v_{2,0} \rightsquigarrow v_{1,0}v_{2,0}\}$ .

**Proposition 3.1.29.** Let  $(\Sigma_r G)_\lambda$  be a weighted  $r$ -suspension of  $G_\omega$  and  $I = I_{r,f}((\Sigma_r G)_\lambda)$ . If  $\mathfrak{P} = (V'', \delta'')$  is a minimal  $f$ -weighted vertex cover of  $(\Sigma_r G)_\lambda$ , then  $\mathfrak{P}_{i,j}(I) \neq \emptyset$  for any  $v_{i,j} \in V''$ .

*Proof.* Suppose that  $\mathfrak{P}_{i,j}(I) = \emptyset$  for some  $v_{i,j} \in V''$ . Then since  $I \subseteq P(V'', \delta'')$  and  $(V'', \delta'')$  is minimal, by Fact 3.1.7, we have that  $I \subseteq P(V'' \setminus \{v_{i,j}\}, \delta''|_{V'' \setminus \{v_{i,j}\}})$ , a contradiction.  $\square$

We have a general version of Proposition 3.1.29, state in the following lemma:

**Lemma 3.1.30.** Let  $(\Sigma_r G)_\lambda$  be a weighted  $r$ -suspension of  $G_\omega$ ,  $I := I_{r,f}((\Sigma_r G)_\lambda)$ , and  $\underline{n} \in \mathbb{N}^d$ . Let  $\mathfrak{P} := (V'', \delta'')$  with  $V'' \subseteq V((\Sigma_r G)_\lambda)$  and  $\delta'' : V'' \rightarrow \mathbb{N}$  be such that  $P(V'', \delta'')$  occurs in an m-irreducible decomposition of  $p_{\underline{n}}(I)$  and  $P(V'' \setminus \{v_{i,j}\}, \delta''|_{V'' \setminus \{v_{i,j}\}})$  doesn’t occur in any m-irreducible decomposition of  $p_{\underline{n}}(I)$ . Then  $\mathfrak{P}_{i,j}(p_{\underline{n}}(I)) \neq \emptyset$  for any  $v_{i,j} \in V''$ . In particular, if  $P(V'', \delta'')$  occurs in an irredundant m-irreducible decomposition of  $p_{\underline{n}}(I)$ , then  $P(V'' \setminus \{v_{i,j}\}, \delta''|_{V'' \setminus \{v_{i,j}\}})$  doesn’t occur in any m-irreducible decomposition of  $p_{\underline{n}}(I)$  for any  $v_{i,j} \in V''$ .

*Proof.* Suppose that  $\mathfrak{P}_{i,j}(p_{\underline{n}}(I)) = \emptyset$  for some  $v_{i,j} \in V''$ . Then since  $p_{\underline{n}}(I) \subseteq P(V'', \delta'')$ , we have that  $p_{\underline{n}}(I) \subseteq P(V'' \setminus \{v_{i,j}\}, \delta''|_{V'' \setminus \{v_{i,j}\}})$ , a contradiction.

Let  $I_k := P(V'', \delta'')$  occur in an irredundant m-irreducible decomposition of  $p_{\underline{n}}(I) = \bigcap_{i=1}^n I_i$  with  $k \in \{1, \dots, n\}$  such that  $P(V'' \setminus \{v_{i,j}\}, \delta''|_{V'' \setminus \{v_{i,j}\}})$  occur in an m-irreducible decomposition of  $p_{\underline{n}}(I)$  for some  $v_{i,j} \in V''$ . Then since  $p_{\underline{n}}(I) \subseteq I_k = P(V'', \delta'')$ , we have that

$$p_{\underline{n}}(I) \subseteq P(V'' \setminus \{v_{i,j}\}, \delta''|_{V'' \setminus \{v_{i,j}\}}) \subsetneq P(V'', \delta'') = I_k.$$

So

$$\bigcap_{i=1}^n I_i = p_{\underline{n}}(I) = P(V'' \setminus \{v_{i,j}\}, \delta''|_{V'' \setminus \{v_{i,j}\}}) \cap \bigcap_{i=1}^n I_i = P(V'' \setminus \{v_{i,j}\}, \delta''|_{V'' \setminus \{v_{i,j}\}}) \cap \bigcap_{i=1, i \neq k}^n I_i.$$

By Fact 2.2.23, the number of ideals in any irredundant m-irreducible decomposition of  $p_{\underline{n}}(I)$  is  $n$ , so the above decomposition on the right is also an irredundant m-irreducible decomposition of  $p_{\underline{n}}(I)$ . Then Fact 2.2.23 implies that  $I_k = P(V'' \setminus \{v_{i,j}\}, \delta''|_{V'' \setminus \{v_{i,j}\}})$ , a contradiction.  $\square$

### 3.2 Sufficient Conditions for Unmixedness

In this section, we prove the sufficient conditions for which the  $f$ -weighted  $r$ -path ideal of a weighted  $r$ -path suspension is unmixed. We divide the classification into 3 kinds of cases. We first discuss the sufficient conditions for  $I_{r,f}((\Sigma_r G)_\lambda)$  to be unmixed for the case  $r = 2$ .

**Proposition 3.2.1.** Let  $(\Sigma_2 G)_\lambda$  be a weighted 2-path suspension of  $G_\omega$  such that

- (a)  $\lambda(v_i v_j) \leq f(\lambda(v_i v_j), \lambda(v_i v_{i,1})) \leq \lambda(v_i v_{i,1})$  and  $\lambda(v_i v_j) \leq f(\lambda(v_i v_j), \lambda(v_j v_{j,1})) \leq \lambda(v_j v_{j,1})$  for all edges  $v_i v_j \in E((\Sigma_2 G)_\lambda)$ ,
- (b)  $\lambda(v_i v_{i,1}) \leq f(\lambda(v_i v_{i,1}), \lambda(v_{i,1} v_{i,2}))$  for  $i = 1, \dots, d$ ,
- (c)  $f(\lambda(v_i v_j), \lambda(v_j v_k)) \leq \min\{f(\lambda(v_i v_j), \lambda(v_j v_{j,1})), f(\lambda(v_k v_j), \lambda(v_j v_{j,1}))\}$  for all 2-paths  $v_i v_j v_k$  in  $G$ ,
- (d) for all 3-paths  $v_i v_j v_k v_l$  in  $G$ : if  $f(\lambda(v_{j,1} v_j), \lambda(v_j v_i)) < \lambda(v_j v_k)$ , then  $f(\lambda(v_j v_k), \lambda(v_k v_l)) \geq \lambda(v_j v_k)$ ,
- (e) for all 3-cycles  $v_i v_j v_k v_i$  in  $G$ : if  $f(\lambda(v_i v_{i,1}), \lambda(v_i v_j)) < \lambda(v_i v_k)$ , then either  $f(\lambda(v_k v_i), \lambda(v_k v_j)) \geq \lambda(v_k v_i)$ , or,  $f(\lambda(v_k v_i), \lambda(v_k v_j)) \geq \lambda(v_k v_j)$  and  $f(\lambda(v_j v_i), \lambda(v_j v_k)) \leq \max\{\lambda(v_j v_i), \lambda(v_j v_k)\}$ .



Let  $I := I_{2,f}((\Sigma_r G)_\lambda)$  and  $\underline{n} = (n_1, \dots, n_d) \in \mathbb{N}^d$ . Let  $\mathfrak{P} := (V'', \delta'')$  with  $V'' \subseteq V((\Sigma_r G)_\lambda)$  and  $\delta'' : V'' \rightarrow \mathbb{N}$  be such that  $P(V'', \delta'')$  occurs in an irredundant m-irreducible decomposition of  $p_{\underline{n}}(I)$ . Then there exists at most one  $v_{i,i_j} \in V''$  for  $i = 1, \dots, d$ . Note also that there exists a  $v_{i,i_j} \in V''$  for  $i = 1, \dots, d$ , so  $p_{\underline{n}}(I)$  is unmixed.

*Proof.* Suppose there exist  $v_{i,\alpha}, v_{i,\beta} \in V''$  with  $0 \leq \alpha < \beta \leq 2$  for some  $i \in \{1, \dots, d\}$ . Then we have the following 3 cases (a), (b), and (c).

(a) Suppose that  $\alpha = 1$  and  $\beta = 2$ . By Lemma 3.1.30, we have  $\mathfrak{P}_{i,1} \neq \emptyset \neq \mathfrak{P}_{i,2}$ . If  $(P_2 \xrightarrow{\underline{n}} \wp) \in \mathfrak{P}_{1,2}$ , then  $v_{1,2} \in V(\wp)$ , as  $(\Sigma_2 G)_\lambda$  is a 2-path suspension, we have  $P_2 \rightsquigarrow \wp$  must be of the unique form  $v_{i,2}v_{i,1}v_{i,0} \rightsquigarrow v_{i,2}v_{i,1}v_{i,0}$ . So we have  $\mathfrak{P}_{i,2}(p_{\underline{n}}(I)) = \{v_{i,2}v_{i,1}v_{i,0}\}$ . Hence  $v_{i,2}v_{i,1}v_{i,0} \notin \mathfrak{P}_{i,1}$ . Also, since  $v_{i,1}$  is in  $V(\wp)$  for any  $P_r \rightsquigarrow \wp$ , we have that  $v_{i,1}v_{i,0}v_{j,0} \in \mathfrak{P}_{i,1}$  for some edge  $v_{i,0}v_{j,0} \in E(G)$ . So we have that  $v_{i,1} \smile v_{i,1}v_{i,0}v_{j,0}$  and then  $\delta''(v_{i,1}) \leq \lambda(v_{i,0}v_{i,1}) \leq f(\lambda(v_{i,0}v_{i,1}), \lambda(v_{i,1}v_{i,2}))$  by Condition (b), implying  $v_{i,1} \smile v_{i,2}v_{i,1}v_{i,0}$ , contradicting the condition  $\mathfrak{P}_{i,2} = \{v_{i,2}v_{i,1}v_{i,0}\}$ .

(b) Suppose that  $\alpha = 0$  and  $\beta = 2$ . Then  $\mathfrak{P}_{i,2} = \{v_{i,2}v_{i,1}v_{i,0}\}$  and  $\mathfrak{P}_{i,0} \neq \emptyset$  by Lemma 3.1.30. It is straightforward to show that we have the following 3 cases:

(1) Assume that  $v_{i,1}v_{i,0}v_{j,0} \in \mathfrak{P}_{i,0}$ . Then we have that  $v_{i,0} \smile v_{i,1}v_{i,0}v_{j,0}$ , and so  $\delta''(v_{i,0}) \leq f(\lambda(v_{i,0}v_{j,0}), \lambda(v_{i,0}v_{i,1})) \leq \lambda(v_{i,0}v_{i,1})$  by Condition (a), implying  $v_{i,0} \smile v_{i,2}v_{i,1}v_{i,0}$ , contradicting  $\mathfrak{P}_{i,2} = \{v_{i,2}v_{i,1}v_{i,0}\}$ .

(2) Assume that  $v_{i,0}v_{j,0}v_{k,0} \in \mathfrak{P}_{i,0}$  or  $(v_{i,0}v_{j,0}v_{j,1} \rightsquigarrow v_{i,0}v_{j,0}) \in \mathfrak{P}_{i,0}$ . Then  $\delta''(v_{i,0}) \leq \lambda(v_{i,0}v_{j,0}) \leq f(\lambda(v_{i,0}v_{j,0}), \lambda(v_{i,0}v_{i,1})) \leq \lambda(v_{i,0}v_{i,1})$  by Condition (a). So we have that  $v_{i,0} \smile v_{i,2}v_{i,1}v_{i,0}$ , contradicting  $\mathfrak{P}_{i,2} = \{v_{i,2}v_{i,1}v_{i,0}\}$ .

(3) Assume that  $v_{j,0}v_{i,0}v_{k,0} \in \mathfrak{P}_{i,0}$ . Then  $\delta''(v_{i,0}) \leq f(\lambda(v_{j,0}v_{i,0}), \lambda(v_{i,0}v_{k,0})) \leq \lambda(v_{i,0}v_{i,1})$  by Conditions (c) and (a), implying  $v_{i,0} \smile v_{i,2}v_{i,1}v_{i,0}$ , contradicting  $\mathfrak{P}_{i,2} = \{v_{i,2}v_{i,1}v_{i,0}\}$ .

(c) Suppose that  $\alpha = 0$  and  $\beta = 1$ . Suppose that  $(v_{i,2}v_{i,1}v_{i,0} \rightsquigarrow v_{i,1}v_{i,0}) \in \mathfrak{P}_{i,1}$ , then  $v_{i,2}v_{i,1}v_{i,0}$  is not a path in  $p_{\underline{n}}(I)$  and similar to Case (b), we have that  $v_{i,0} \smile (v_{i,2}v_{i,1}v_{i,0} \rightsquigarrow v_{i,1}v_{i,0})$ , a contradiction. Similarly, we have that  $v_{i,2}v_{i,1}v_{i,0} \notin \mathfrak{P}_{i,1}$ . So there exists  $v_{i,1}v_{i,0}v_{j_1,0} \in \mathfrak{P}_{i,1}$ . Then we have that  $(v_{j_1,1}v_{j_1,0}v_{i,0} \rightsquigarrow v_{j_1,0}v_{i,0}) \notin \mathfrak{P}_{i,0}$ ,  $v_{k,0}v_{j_1,0}v_{i,0} \notin \mathfrak{P}_{i,0}$  for any  $v_{k,0}v_{j_1,0} \in E(G)$ , and  $v_{j_1,0}v_{i,0}v_{l,0} \notin \mathfrak{P}_{i,0}$  for any  $v_{i,0}v_{l,0} \in E(G)$ .

(1) Assume that  $v_{k,0}v_{i,0}v_{l,0} \in \mathfrak{P}_{i,0}$  with  $k \neq j_1$ . (The following drawing shows part of  $p_{\underline{n}}(\Sigma_r G)$ )

after setting  $p_{\underline{n}}(v_{i,j}) = v_{i_1,j_1}$  and deleting the corresponding edges whenever  $p_{\underline{n}}(X_{i,j}) = X_{i_1,j_1}$ .

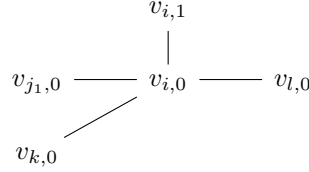

Since  $v_{i,1}v_{i,0}v_{j_1,0} \in \mathfrak{P}_{i,1}$ , we have that  $v_{j_1,0}, v_{i,0} \not\sim v_{j_1,0}v_{i,0}v_{l,0}$  through Conditions (a) and (c). Then since  $p_{\underline{n}}(I) \subseteq P(V'', \delta'')$ , we have that  $v_{l,0} \sim v_{j_1,0}v_{i,0}v_{l,0}$  by Lemma 3.1.26. So we have that  $v_{l,0} \sim v_{k,0}v_{i,0}v_{l,0}$ , contradicting  $v_{k,0}v_{i,0}v_{l,0} \in \mathfrak{P}_{i,0}$ .

(2) Assume that  $(v_{i,0}v_{p_1,0}v_{p_1,1} \rightsquigarrow v_{i,0}v_{p_1,0}) \in \mathfrak{P}_{i,0}$  with  $p_1 \neq j_1$ .

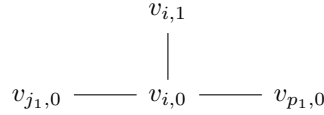

Similar to Case (c)(1), we have that  $v_{p_1,0} \sim v_{j_1,0}v_{i,0}v_{p_1,0}$  and then  $v_{p_1,0} \sim (v_{i,0}v_{p_1,0}v_{p_1,1} \rightsquigarrow v_{i,0}v_{p_1,0})$ , contradicting  $(v_{i,0}v_{p_1,0}v_{p_1,1} \rightsquigarrow v_{i,0}v_{p_1,0}) \in \mathfrak{P}_{i,0}$ .

(3) Assume that  $v_{i,0}v_{p_1,0}v_{p_2,p_2} \in \mathfrak{P}_{i,0}$  with  $p_1 \neq j_1$ .

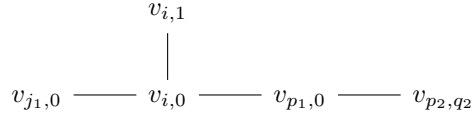

Similar to Case (c)(1), we have  $v_{p_1,0} \sim v_{j_1,0}v_{i,0}v_{p_1,0}$ . As  $v_{i,0}v_{p_1,0}v_{p_2,q_2} \in \mathfrak{P}_{i,0}$ , we have  $v_{p_1,0} \not\sim v_{i,0}v_{p_1,0}v_{p_2,q_2}$ . Then  $f(\lambda(v_{i,0}v_{p_1,0}), \lambda(v_{p_1,0}v_{p_2,q_2})) < \delta''(v_{p_1,0}) \leq \lambda(v_{i,0}v_{p_1,0})$  and hence  $q_2 = 0$ . As  $v_{i,0} \sim v_{i,0}v_{p_1,0}v_{p_2,q_2}$  and  $v_{i,0} \not\sim v_{i,1}v_{i,0}v_{j_1,0}$ , we have  $f(\lambda(v_{i,1}v_{i,0}), \lambda(v_{i,0}v_{j_1,0})) < \lambda(v_{i,0}v_{p_1,0})$ .

(i) Assume that  $j_1 \neq p_2$ . Then  $v_{j_1,0}v_{i,0}v_{p_1,0}v_{p_2,q_2}$  is a 3-path in  $G$ . As  $f(\lambda(v_{i,1}v_{i,0}), \lambda(v_{i,0}v_{j_1,0})) < \lambda(v_{i,0}v_{p_1,0})$ , we have that  $f(\lambda(v_{i,0}v_{p_1,0}), \lambda(v_{p_1,0}v_{p_2,q_2})) \geq \lambda(v_{i,0}v_{p_1,0})$  by Condition (d), contradicting  $v_{p_1,0} \sim v_{j_1,0}v_{i,0}v_{p_1,0}$  and  $v_{p_1,0} \not\sim v_{i,0}v_{p_1,0}v_{p_2,q_2}$ .

(ii) Assume that  $j_1 = p_2$ .

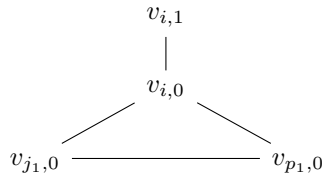

Then  $v_{i,0}v_{j_1,0}v_{p_1,0}v_{i,0}$  is a 3-cycle in  $G$  and  $f(\lambda(v_{i,1}v_{i,0}), \lambda(v_{i,0}v_{j_1,0})) < \lambda(v_{i,0}v_{p_1,0})$ . So by Condition (e), we have the following 2 cases:

- A. Assume that  $f(\lambda(v_{p_1,0}v_{j_1,0}), \lambda(v_{p_1,0}v_{i,0})) \geq \lambda(v_{p_1,0}v_{i,0})$ . Similar to Case (c)(1), we have that  $v_{p_1,0} \smile v_{j_1,0}v_{i,0}v_{p_1,0}$ . So we have that  $v_{p_1,0} \smile v_{i,0}v_{p_1,0}v_{j_1,0}$ , contradicting  $v_{i,0}v_{p_1,0}v_{j_1,0} \in \mathfrak{P}_{i,0}$ .
- B. Assume now that  $f(\lambda(v_{p_1,0}v_{j_1,0}), \lambda(v_{p_1,0}v_{i,0})) \geq \lambda(v_{p_1,0}v_{j_1,0})$  and  $f(\lambda(v_{j_1,0}v_{i,0}), \lambda(v_{j_1,0}v_{p_1,0})) \leq \max\{\lambda(v_{j_1,0}v_{i,0}), \lambda(v_{j_1,0}v_{p_1,0})\}$ . Then since  $v_{j_1,0} \not\smile v_{j_1,0}v_{i,0}v_{i,1}$  and  $v_{j_1,0} \not\smile v_{j_1,0}v_{p_1,0}v_{i,0}$ , we have that  $v_{j_1,0} \not\smile v_{i,0}v_{j_1,0}v_{p_1,0}$ . Since  $v_{p_1,0} \not\smile v_{i,0}v_{p_1,0}v_{j_1,0}$ , we have that  $v_{p_1,0} \not\smile v_{i,0}v_{j_1,0}v_{p_1,0}$ , contradicting Lemma 3.1.26.

Note that for  $i = 1, \dots, d$ , by definition of  $p_{\underline{n}}(I)$ , there exists a generator where all variables are of the form  $X_{i,i_l}$  with  $i_l \in \{0, 1, 2\}$ , so there exists a vertex  $v_{i,i_j} \in V''$ .  $\square$

Starting here, we discuss the sufficient conditions for  $I_{r,f}((\Sigma_r G)_\lambda)$  to be unmixed if  $r = 3$ .

**Notation 3.2.2.** We consider the next conditions on a weighted 3-path suspension  $(\Sigma_3 G)_\lambda$  of  $G_\omega$ .

(a)  $\lambda(v_i v_j) \leq f(\lambda(v_i v_j), \lambda(v_i v_{i,1})) \leq \lambda(v_i v_{i,1})$  and  $\lambda(v_i v_j) \leq f(\lambda(v_i v_j), \lambda(v_j v_{j,1})) \leq \lambda(v_j v_{j,1})$  for all edges  $v_i v_j \in E((\Sigma_3 G)_\lambda)$ ,

(b)  $\lambda(v_{i,k} v_{i,k+1}) \leq f(\lambda(v_{i,k} v_{i,k+1}), \lambda(v_{i,k+1} v_{i,k+2}))$  for  $i = 1, \dots, d$  and  $k = 0, 1$ ,

(c)  $f(\lambda(v_i v_j), \lambda(v_j v_k)) \leq \min\{f(\lambda(v_i v_j), \lambda(v_j v_{j,1})), f(\lambda(v_k v_j), \lambda(v_j v_{j,1}))\}$  for all 2-paths  $v_i v_j v_k$  in  $G$

(d) for all 4-paths  $v_i v_j v_k v_l v_m$  in  $G$ : if  $f(\lambda(v_{j,1} v_j), \lambda(v_j v_i)) < \lambda(v_j v_k)$  or  $f(\lambda(v_{k,1} v_k), \lambda(v_k v_j)) < \lambda(v_k v_l)$ , then  $f(\lambda(v_i v_j), \lambda(v_j v_k)) \geq \lambda(v_j v_k)$  or  $f(\lambda(v_k v_l), \lambda(v_l v_m)) \geq \lambda(v_k v_l)$ ,

(e) for all 3-cycles  $v_i v_j v_k v_i$  in  $G$ :

(1) if  $f(\lambda(v_i v_{i,1}), \lambda(v_i v_j)) < f(\lambda(v_i v_{i,1}), \lambda(v_i v_k))$  or there exists  $v_i v_l \in E(G)$  with  $j \neq l \neq k$  such that  $f(\lambda(v_i v_{i,1}), \lambda(v_i v_j)) < f(\lambda(v_i v_l), \lambda(v_i v_k))$ , then  $f(\lambda(v_j v_i), \lambda(v_j v_k)) \leq \max\{\lambda(v_j v_i), \lambda(v_j v_k)\}$  and  $f(\lambda(v_k v_i), \lambda(v_k v_j)) \geq \lambda(v_k v_j)$ , and

(2) if  $f(\lambda(v_i v_{i,1}), \lambda(v_i v_j)) < \lambda(v_i v_k)$ , then

(i)  $f(\lambda(v_k v_i), \lambda(v_k v_j)) \geq \lambda(v_k v_i)$ , and

(ii) for any  $v_j v_{l_1, l_2} \in E((\Sigma_3 G)_\lambda)$  with  $v_i \neq v_{l_1, l_2} \neq v_k$ ,

$$\begin{cases} f(\lambda(v_j v_i), \lambda(v_j v_{l_1, l_2})) \leq \max\{\lambda(v_j v_i), f(\lambda(v_j v_k), \lambda(v_j v_{l_1, l_2}))\}, \text{ and} \\ f(\lambda(v_j v_i), \lambda(v_j v_{l_1, l_2})) \leq \max\{f(\lambda(v_j v_i), \lambda(v_j v_k)), f(\lambda(v_j v_k), \lambda(v_j v_{l_1, l_2}))\}, \end{cases}$$

and

(iii)

$$\left\{ \begin{array}{l} f(\lambda(v_k v_j), \lambda(v_k v_{l_1, l_2})) \leq \max\{\lambda(v_k v_j), f(\lambda(v_k v_i), \lambda(v_k v_{l_1, l_2}))\} \\ \quad \forall v_k v_{l_1, l_2} \in E((\Sigma_3 G)_\lambda) \text{ with } v_i \neq v_{l_1, l_2} \neq v_k, \\ \text{or } f(\lambda(v_j v_i), \lambda(v_j v_k)) \geq \lambda(v_j v_i), \end{array} \right.$$

(f) for all 4-cycles  $v_i v_j v_k v_l v_i$ : if  $f(\lambda(v_i, v_j), \lambda(v_i v_j)) < \lambda(v_i v_l)$ , then either

(1)

$$f(\lambda(v_k v_j), \lambda(v_k v_l)) \geq \lambda(v_k v_l) \text{ and } f(\lambda(v_j v_i), \lambda(v_j v_k)) \geq \lambda(v_j v_i),$$

or

(2) (i)  $f(\lambda(v_l v_i), \lambda(v_l v_k)) \geq \min\{\lambda(v_l v_i), \lambda(v_l v_k)\}$ , and

(ii)  $f(\lambda(v_j v_i), \lambda(v_j v_k)) \leq \max\{\lambda(v_j v_i), \lambda(v_j v_k)\}$ , and

(iii)

$$\left\{ \begin{array}{l} \text{either } f(\lambda(v_k v_j), \lambda(v_k v_l)) \geq \lambda(v_k v_l), \\ \text{or } f(\lambda(v_l v_i), \lambda(v_l v_k)) \geq \lambda(v_l v_k) \text{ and} \\ \quad \text{if } v_j v_l \in E(G), \text{ then } f(\lambda(v_j v_i), \lambda(v_j v_k)) \leq \max\{\lambda(v_j v_k), f(\lambda(v_j v_i), \lambda(v_j v_l))\}, \\ \text{or } f(\lambda(v_k v_j), \lambda(v_k v_l)) \geq \lambda(v_k v_j) \text{ and } f(\lambda(v_l v_i), \lambda(v_l v_k)) \geq \lambda(v_l v_i) \text{ and} \\ \quad \text{if } v_j v_l \in E(G), \text{ then } f(\lambda(v_j v_i), \lambda(v_j v_k)) \leq \max\{\lambda(v_j v_k), f(\lambda(v_j v_i), \lambda(v_j v_l))\}, \end{array} \right.$$

and

(iv)

$$\left\{ \begin{array}{l} \text{either } f(\lambda(v_j v_i), \lambda(v_j v_k)) \geq \lambda(v_j v_i), \\ \text{or } f(\lambda(v_l v_i), \lambda(v_l v_k)) \geq \lambda(v_l v_i), \\ \text{or } f(\lambda(v_l v_i), \lambda(v_l v_k)) \geq \min\{\lambda(v_l v_i), \lambda(v_l v_k)\} \text{ and } f(\lambda(v_k v_j), \lambda(v_k v_l)) \leq \lambda(v_k v_l), \\ \text{or } \forall v_k v_{l_1, l_2} \in E((\Sigma_3 G)_\lambda) \text{ with } v_j \neq v_{l_1, l_2} \neq v_l : \\ \quad \text{either } f(\lambda(v_k v_j), \lambda(v_k v_l)) \leq \max\{\lambda(v_k v_j), f(\lambda(v_k v_l), \lambda(v_k v_{l_1, l_2}))\}, \\ \quad \text{or } f(\lambda(v_k v_j), \lambda(v_k v_{l_1, l_2})) \leq \max\{\lambda(v_k v_j), f(\lambda(v_k v_l), \lambda(v_k v_{l_1, l_2}))\}, \end{array} \right.$$

and

$$(v) \quad \left\{ \begin{array}{l} \text{either } f(\lambda(v_k v_j), \lambda(v_k v_l)) \geq \lambda(v_k v_l), \\ \text{or } f(\lambda(v_l v_i), \lambda(v_l v_k)) \geq \lambda(v_l v_i), \\ \text{or } \forall v_j v_{l_1, l_2} \in E((\Sigma_3 G)_\lambda) \text{ with } v_i \neq v_{l_1, l_2} \neq v_k : \\ \quad \text{either } f(\lambda(v_j v_i), \lambda(v_j v_k)) \leq \max\{\lambda(v_j v_k), f(\lambda(v_j v_i), \lambda(v_j v_{l_1, l_2}))\}, \\ \quad \text{or } f(\lambda(v_j v_k), \lambda(v_j v_{l_1, l_2})) \leq \max\{\lambda(v_j v_k), f(\lambda(v_j v_i), \lambda(v_j v_{l_1, l_2}))\}. \end{array} \right.$$

The next results show that  $p_{\underline{n}}(I)$  is unmixed in the setting of Notation 3.2.2. See Proposition 3.2.43 for the full conclusion.

**Proposition 3.2.3.** Let  $(\Sigma_3 G)_\lambda$  be a weighted 3-path suspension of  $G_\omega$  that satisfies the conditions from Notation 3.2.2. Let  $I := I_{3,f}((\Sigma_3 G)_\lambda)$  and  $\underline{n} \in \mathbb{N}^d$ . Let  $\mathfrak{P} := (V'', \delta'')$  with  $V'' \subseteq V((\Sigma_3 G)_\lambda)$  and  $\delta'' : V'' \rightarrow \mathbb{N}$  be such that  $P(V'', \delta'')$  occurs in an m-irreducible decomposition of  $p_{\underline{n}}(I)$  and  $P(V'' \setminus \{v_{i,j}\}, \delta''|_{V'' \setminus \{v_{i,j}\}})$  does not occur in any m-irreducible decomposition of  $p_{\underline{n}}(I)$  for any  $v_{i,j} \in V''$ . Then for  $i = 1, \dots, d$ , we have  $v_{i,\alpha} \notin V''$  or  $v_{i,\beta} \notin V''$  for any  $(\alpha, \beta) \in \{(1, 2), (1, 3), (2, 3)\}$ .

*Proof.* Proof by contradiction: assume that there exist such  $v_{i,\alpha} \in V''$  and  $v_{i,\beta} \in V''$ . Then  $\mathfrak{P}_{i,\alpha} \neq \emptyset$  by Lemma 3.1.30. So

$$\delta''(v_{i,\alpha}) \leq \max\{\lambda(v_{i,\alpha} v_{i,\alpha-1}), f(\lambda(v_{i,\alpha+1} v_{i,\alpha}), \lambda(v_{i,\alpha} v_{i,\alpha-1}))\} = f(\lambda(v_{i,\alpha+1} v_{i,\alpha}), \lambda(v_{i,\alpha} v_{i,\alpha-1})),$$

by Notation 3.2.2(b). Then for any  $(P_r \rightsquigarrow \wp) \in \mathfrak{P}_{i,\beta}$  we have that  $v_{i,\alpha} \smile (P_r \rightsquigarrow \wp)$ , contradiction by the definition of  $\mathfrak{P}_{i,\beta}$  and  $\alpha \neq \beta$ .  $\square$

**Proposition 3.2.4.** Let  $(\Sigma_3 G)_\lambda$  be a weighted 3-path suspension of  $G_\omega$  that satisfies the conditions from Notation 3.2.2. Let  $I := I_{3,f}((\Sigma_3 G)_\lambda)$  and  $\underline{n} \in \mathbb{N}^d$ . Let  $\mathfrak{P} := (V'', \delta'')$  with  $V'' \subseteq V((\Sigma_3 G)_\lambda)$  and  $\delta'' : V'' \rightarrow \mathbb{N}$  be such that  $P(V'', \delta'')$  occurs in an m-irreducible decomposition of  $p_{\underline{n}}(I)$  and  $P(V'' \setminus \{v_{i,j}\}, \delta''|_{V'' \setminus \{v_{i,j}\}})$  does not occur in any m-irreducible decomposition of  $p_{\underline{n}}(I)$  for any  $v_{i,j} \in V''$ . Then for  $i = 1, \dots, d$ , we have  $v_{i,0} \notin V''$  or  $v_{i,3} \notin V''$ .

*Proof.* Proof by contradiction: assume that  $v_{i,0} \in V''$  and  $v_{i,3} \in V''$ . Then  $\mathfrak{P}_{i,3} = \{v_{i,3} v_{i,2} v_{i,1} v_{i,0}\}$  and  $\mathfrak{P}_{i,0} \neq \emptyset$ , by Lemma 3.1.30. So we have the following 3 cases:

(a) Assume that  $v_{i,2} v_{i,1} v_{i,0} v_{j,0} \in \mathfrak{P}_{i,0}$ ,  $v_{i,1} v_{i,0} v_{j,0} v_{k,l} \in \mathfrak{P}_{i,0}$ , or  $(v_{i,1} v_{i,0} v_{j,0} v_{j,1} \rightsquigarrow v_{i,1} v_{i,0} v_{j,0}) \in \mathfrak{P}_{i,0}$ . Then we have that  $\delta''(v_{i,0}) \leq f(\lambda(v_{i,0} v_{j,0}), \lambda(v_{i,0} v_{i,1})) \leq \lambda(v_{i,0} v_{i,1})$  by Notation 3.2.2(a), implying  $v_{i,0} \smile v_{i,3} v_{i,2} v_{i,1} v_{i,0}$ , contradicting  $\mathfrak{P}_{i,3} = \{v_{i,3} v_{i,2} v_{i,1} v_{i,0}\}$ .

(b) Assume that  $v_{i,0}v_{j,0}v_{k,0}v_{l,m} \in \mathfrak{P}_{i,0}$ ,  $v_{i,0}v_{j,0}v_{j,1}v_{j,2} \in \mathfrak{P}_{i,0}$ ,  $(v_{i,0}v_{j,0}v_{j,1}v_{j,2} \rightsquigarrow v_{i,0}v_{j,0}v_{j,1}) \in \mathfrak{P}_{i,0}$ , or  $(v_{i,0}v_{j,0}v_{j,1}v_{j,2} \rightsquigarrow v_{i,0}v_{j,0}) \in \mathfrak{P}_{i,0}$ . Then  $\delta''(v_{i,0}) \leq \lambda(v_{i,0}v_{j,0}) \leq f(\lambda(v_{i,0}v_{j,0}), \lambda(v_{i,0}v_{i,1})) \leq \lambda(v_{i,0}v_{i,1})$  by Notation 3.2.2(a). So we have that  $v_{i,0} \smile v_{i,3}v_{i,2}v_{i,1}v_{i,0}$ , contradicting  $\mathfrak{P}_{i,3} = \{v_{i,3}v_{i,2}v_{i,1}v_{i,0}\}$ .

(c) Assume that  $v_{j,0}v_{i,0}v_{k,0}v_{l,m} \in \mathfrak{P}_{i,0}$  or  $(v_{j,0}v_{i,0}v_{k,1}v_{k,0} \rightsquigarrow v_{j,0}v_{i,0}v_{k,0}) \in \mathfrak{P}_{i,0}$ . Then  $\delta''(v_{i,0}) \leq f(\lambda(v_{j,0}v_{i,0}), \lambda(v_{i,0}v_{k,0})) \leq \lambda(v_{i,0}v_{i,1})$  by Notations 3.2.2(c) and (a), implying  $v_{i,0} \smile v_{i,3}v_{i,2}v_{i,1}v_{i,0}$ , contradicting  $\mathfrak{P}_{i,3} = \{v_{i,3}v_{i,2}v_{i,1}v_{i,0}\}$ .  $\square$

Propositions 3.2.5 to 3.2.15 will be used to prove a result similar to the one in Proposition 3.2.4.

**Proposition 3.2.5.** Let  $(\Sigma_3 G)_\lambda$  be a weighted 3-path suspension of  $G_\omega$  that satisfies the conditions from Notation 3.2.2. Let  $I := I_{3,f}((\Sigma_3 G)_\lambda)$  and  $\underline{n} \in \mathbb{N}^d$ . Let  $\mathfrak{P} := (V'', \delta'')$  with  $V'' \subseteq V((\Sigma_3 G)_\lambda)$  and  $\delta'' : V'' \rightarrow \mathbb{N}$  be such that  $P(V'', \delta'')$  occurs in an m-irreducible decomposition of  $p_{\underline{n}}(I)$  and  $P(V'' \setminus \{v_{i,j}\}, \delta''|_{V'' \setminus \{v_{i,j}\}})$  does not occur in any m-irreducible decomposition of  $p_{\underline{n}}(I)$  for any  $v_{i,j} \in V''$ . Assume that  $v_{i,2}v_{i,1}v_{i,0}v_{j_1,0} \in \mathfrak{P}_{i,2}$  for some  $v_{i,0}v_{j_1,0} \in E(G)$ , then  $(v_{i,1}v_{i,0}v_{p_1,0}v_{p_1,1} \rightsquigarrow v_{i,1}v_{i,0}v_{p_1,0}) \notin \mathfrak{P}_{i,0}$  for any  $v_{i,0}v_{p_1,0} \in E(G)$  such that  $p_1 \neq j_1$ .

*Proof.* Proof by contradiction: assume that  $(v_{i,1}v_{i,0}v_{p_1,0}v_{p_1,1} \rightsquigarrow v_{i,1}v_{i,0}v_{p_1,0}) \in \mathfrak{P}_{i,0}$  for some  $v_{i,0}v_{p_1,0} \in E(G)$  such that  $p_1 \neq j_1$ .

$$\begin{array}{ccccc}
 & & v_{i,2} & & \\
 & & | & & \\
 & & v_{i,1} & & \\
 & & | & & \\
 v_{j_1,0} & \text{---} & v_{i,0} & \text{---} & v_{p_1,0}
 \end{array}$$

Then we have that  $v_{p_1,0} \not\prec (v_{j_1,0}v_{i,0}v_{p_1,0}v_{p_1,1} \rightsquigarrow v_{j_1,0}v_{i,0}v_{p_1,0})$ . Since  $v_{i,2}v_{i,1}v_{i,0}v_{j_1,0} \in \mathfrak{P}_{i,2}$ , through Notation 3.2.2(c) we have that  $v_{j_1,0}, v_{i,0} \not\prec (v_{j_1,0}v_{i,0}v_{p_1,0}v_{p_1,1} \rightsquigarrow v_{j_1,0}v_{i,0}v_{p_1,0})$ , contradicting Lemma 3.1.26.  $\square$

**Proposition 3.2.6.** Let  $(\Sigma_3 G)_\lambda$  be a weighted 3-path suspension of  $G_\omega$  that satisfies the conditions from Notation 3.2.2. Let  $I := I_{3,f}((\Sigma_3 G)_\lambda)$  and  $\underline{n} \in \mathbb{N}^d$ . Let  $\mathfrak{P} := (V'', \delta'')$  with  $V'' \subseteq V((\Sigma_3 G)_\lambda)$  and  $\delta'' : V'' \rightarrow \mathbb{N}$  be such that  $P(V'', \delta'')$  occurs in an m-irreducible decomposition of  $p_{\underline{n}}(I)$  and  $P(V'' \setminus \{v_{i,j}\}, \delta''|_{V'' \setminus \{v_{i,j}\}})$  does not occur in any m-irreducible decomposition of  $p_{\underline{n}}(I)$  for any

$v_{i,j} \in V''$ . Assume that  $v_{i,2}v_{i,1}v_{i,0}v_{j_1,0} \in \mathfrak{P}_{i,2}$  for a  $v_{i,0}v_{j_1,0} \in E(G)$ , then  $v_{i,1}v_{i,0}v_{p_1,0}v_{p_2,q_2} \notin \mathfrak{P}_{i,0}$  for any 2-path  $v_i v_{p_1,0} v_{p_2,q_2}$  in  $\Sigma_3 G$  such that  $p_1 \neq j_1$  and  $v_{p_2,q_2} \neq v_{j_1,0}$ .

*Proof.* Proof by contradiction: assume that  $v_{i,1}v_{i,0}v_{p_1,0}v_{p_2,q_2} \in \mathfrak{P}_{i,0}$  for some 2-path  $v_i v_{p_1,0} v_{p_2,q_2}$  in  $\Sigma_3 G$  such that  $p_1 \neq j_1$  and  $v_{p_2,q_2} \neq v_{j_1,0}$ .

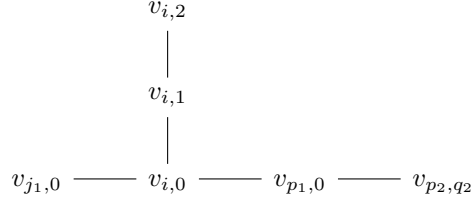

Since  $v_{i,2}v_{i,1}v_{i,0}v_{j_1,0} \in \mathfrak{P}_{i,2}$ , we have that  $v_{j_1,0}, v_{i,0} \not\prec v_{j_1,0}v_{i,0}v_{p_1,0}v_{p_2,q_2}$  by Notation 3.2.2(c). Note that  $v_{i,1}v_{i,0}v_{p_1,0}v_{p_2,q_2} \in \mathfrak{P}_{i,0}$ , so  $v_{p_1,0}, v_{p_2,q_2} \not\prec v_{j_1,0}v_{i,0}v_{p_1,0}v_{p_2,q_2}$ , contradicting  $p_{\underline{n}}(I) \subseteq P(V'', \delta'')$  and Lemma 3.1.26.  $\square$

**Proposition 3.2.7.** Let  $(\Sigma_3 G)_\lambda$  be a weighted 3-path suspension of  $G_\omega$  that satisfies the conditions from Notation 3.2.2. Let  $I := I_{3,f}((\Sigma_3 G)_\lambda)$  and  $\underline{n} \in \mathbb{N}^d$ . Let  $\mathfrak{P} := (V'', \delta'')$  with  $V'' \subseteq V((\Sigma_3 G)_\lambda)$  and  $\delta'' : V'' \rightarrow \mathbb{N}$  be such that  $P(V'', \delta'')$  occurs in an m-irreducible decomposition of  $p_{\underline{n}}(I)$  and  $P(V'' \setminus \{v_{i,j}\}, \delta''|_{V'' \setminus \{v_{i,j}\}})$  does not occur in any m-irreducible decomposition of  $p_{\underline{n}}(I)$  for any  $v_{i,j} \in V''$ . Assume that  $v_{i,2}v_{i,1}v_{i,0}v_{j_1,0} \in \mathfrak{P}_{i,2}$  for a  $v_{i,0}v_{j_1,0} \in E(G)$ , then  $v_{i,1}v_{i,0}v_{p_1,0}v_{p_2,q_2} \notin \mathfrak{P}_{i,0}$  for any 2-path  $v_i v_{p_1,0} v_{p_2,q_2}$  in  $\Sigma_3 G$  such that  $p_1 \neq j_1$  and  $v_{p_2,q_2} = v_{j_1,0}$ .

*Proof.* Proof by contradiction: assume that  $v_{i,1}v_{i,0}v_{p_1,0}v_{p_2,q_2} \in \mathfrak{P}_{i,0}$  for some 2-path  $v_i v_{p_1,0} v_{p_2,q_2}$  in  $\Sigma_3 G$  such that  $p_1 \neq j_1$  and  $v_{p_2,q_2} = v_{j_1,0}$ . Then  $v_{i,0}v_{j_1,0}v_{p_1,0}v_{i,0}$  is a 3-cycle in  $G_\omega$ .

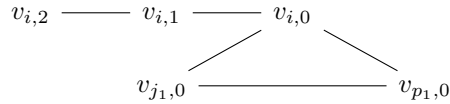

Since  $v_{i,2}v_{i,1}v_{i,0}v_{j_1,0} \in \mathfrak{P}_{i,2}$ , we have that  $v_{i,0} \not\prec v_{i,1}v_{i,0}v_{j_1,0}v_{p_1,0}$  and  $f(\lambda(v_{i,0}v_{i,1}), \lambda(v_{i,0}v_{j_1,0})) < f(\lambda(v_{i,0}v_{i,1}), \lambda(v_{i,0}v_{p_1,0}))$ . Then  $f(\lambda(v_{j_1,0}v_{i,0}), \lambda(v_{j_1,0}v_{j_1,p_1})) \leq \max\{\lambda(v_{j_1,0}v_{i,0}), \lambda(v_{j_1,0}v_{j_1,p_1})\}$  and  $f(\lambda(v_{p_1,0}v_{j_1,0}), \lambda(v_{p_1,0}v_{i,0})) \geq \lambda(v_{p_1,0}v_{j_1,0})$  by Notation 3.2.2(e)(1). Hence we can show  $v_{j_1,0}, v_{p_1,0} \not\prec v_{i,1}v_{i,0}v_{j_1,0}v_{p_1,0}$  by way of contradiction. By similar to the proof of Proposition 3.2.3, we have that  $v_{i,1} \notin V''$ , so  $v_{i,1} \not\prec v_{i,1}v_{i,0}v_{j_1,0}v_{p_1,0}$ , contradicting Lemma 3.1.26.  $\square$

**Proposition 3.2.8.** Let  $(\Sigma_3 G)_\lambda$  be a weighted 3-path suspension of  $G_\omega$  that satisfies the conditions from Notation 3.2.2. Let  $I := I_{3,f}((\Sigma_3 G)_\lambda)$  and  $\underline{n} \in \mathbb{N}^d$ . Let  $\mathfrak{P} := (V'', \delta'')$  with  $V'' \subseteq V((\Sigma_3 G)_\lambda)$  and  $\delta'' : V'' \rightarrow \mathbb{N}$  be such that  $P(V'', \delta'')$  occurs in an m-irreducible decomposition of  $p_{\underline{n}}(I)$  and  $P(V'' \setminus \{v_{i,j}\}, \delta''|_{V'' \setminus \{v_{i,j}\}})$  does not occur in any m-irreducible decomposition of  $p_{\underline{n}}(I)$  for any  $v_{i,j} \in V''$ . Assume that  $v_{i,2}v_{i,1}v_{i,0}v_{j_1,0} \in \mathfrak{P}_{i,2}$  for some  $v_{i,0}v_{j_1,0} \in E(G)$ , then  $(v_{k,0}v_{i,0}v_{p_1,0}v_{p_1,1} \rightsquigarrow v_{k,0}v_{i,0}v_{p_1,0}) \notin \mathfrak{P}_{i,0}$  for any 3-path  $v_{k,0}v_{i,0}v_{p_1,0}$  in  $G$  such that  $k \neq j_1 \neq p_1$ .

*Proof.* Proof by contradiction: assume that  $(v_{k,0}v_{i,0}v_{p_1,0}v_{p_1,1} \rightsquigarrow v_{k,0}v_{i,0}v_{p_1,0}) \in \mathfrak{P}_{i,0}$  for some 3-path  $v_{k,0}v_{i,0}v_{p_1,0}$  in  $G$  such that  $k \neq j_1 \neq p_1$ .

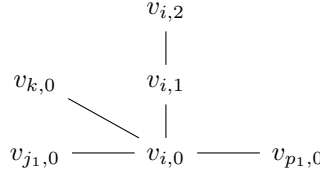

So we have that  $v_{p_1,0}, v_{p_2,q_2} \not\sim (v_{j_1,0}v_{i,0}v_{p_1,0}v_{p_1,1} \rightsquigarrow v_{j_1,0}v_{i,0}v_{p_1,0})$ . Then it follows that  $v_{j_1,0} \smile (v_{j_1,0}v_{i,0}v_{p_1,0}v_{p_1,1} \rightsquigarrow v_{j_1,0}v_{i,0}v_{p_1,0})$  or  $v_{i,0} \smile (v_{j_1,0}v_{i,0}v_{p_1,0}v_{p_1,1} \rightsquigarrow v_{j_1,0}v_{i,0}v_{p_1,0})$  by Lemma 3.1.26. Hence  $v_{j_1,0} \smile v_{i,2}v_{i,1}v_{i,0}v_{j_1,0}$  or  $v_{i,0} \smile v_{i,2}v_{i,1}v_{i,0}v_{j_1,0}$  by Notation 3.2.2(c), contradicting the condition  $v_{i,2}v_{i,1}v_{i,0}v_{j_1,0} \in \mathfrak{P}_{i,2}$ .  $\square$

**Proposition 3.2.9.** Let  $(\Sigma_3 G)_\lambda$  be a weighted 3-path suspension of  $G_\omega$  that satisfies the conditions from Notation 3.2.2. Let  $I := I_{3,f}((\Sigma_3 G)_\lambda)$  and  $\underline{n} \in \mathbb{N}^d$ . Let  $\mathfrak{P} := (V'', \delta'')$  with  $V'' \subseteq V((\Sigma_3 G)_\lambda)$  and  $\delta'' : V'' \rightarrow \mathbb{N}$  be such that  $P(V'', \delta'')$  occurs in an m-irreducible decomposition of  $p_{\underline{n}}(I)$  and  $P(V'' \setminus \{v_{i,j}\}, \delta''|_{V'' \setminus \{v_{i,j}\}})$  does not occur in any m-irreducible decomposition of  $p_{\underline{n}}(I)$  for any  $v_{i,j} \in V''$ . Assume that  $v_{i,2}v_{i,1}v_{i,0}v_{j_1,0} \in \mathfrak{P}_{i,2}$  for a  $v_{i,0}v_{j_1,0} \in E(G)$ , then  $v_{k,0}v_{i,0}v_{p_1,0}v_{p_2,q_2} \notin \mathfrak{P}_{i,0}$  for any 3-path  $v_{k,0}v_{i,0}v_{p_1,0}v_{p_2,q_2}$  in  $\Sigma_3 G$  such that  $k \neq j_1 \neq p_1$  and  $v_{j_1,0} \neq v_{p_2,q_2}$ .

*Proof.* Proof by contradiction: assume that  $v_{k,0}v_{i,0}v_{p_1,0}v_{p_2,q_2} \notin \mathfrak{P}_{i,0}$  for a 3-path  $v_{k,0}v_{i,0}v_{p_1,0}v_{p_2,q_2}$  in  $\Sigma_3 G$  such that  $k \neq j_1 \neq p_1$  and  $v_{j_1,0} \neq v_{p_2,q_2}$ .

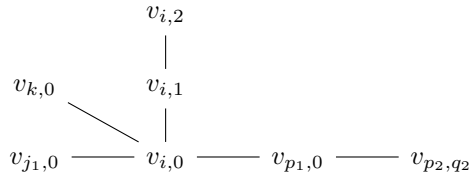



Then we have that  $v_{p_1,0}, v_{p_2,q_2} \not\sim v_{j_1,0}v_{i,0}v_{p_1,0}v_{p_2,q_2}$ . So we have that  $v_{j_1,0} \smile v_{j_1,0}v_{i,0}v_{p_1,0}v_{p_2,q_2}$  or  $v_{i,0} \smile v_{j_1,0}v_{i,0}v_{p_1,0}v_{p_2,q_2}$  by Lemma 3.1.26. Hence  $v_{j_1,0} \smile v_{i,2}v_{i,1}v_{i,0}v_{j_1,0}$  or  $v_{i,0} \smile v_{i,2}v_{i,1}v_{i,0}v_{j_1,0}$  by Notation 3.2.2(c), contradicting  $v_{i,2}v_{i,1}v_{i,0}v_{j_1,0} \in \mathfrak{P}_{i,2}$ .  $\square$

**Proposition 3.2.10.** Let  $(\Sigma_3 G)_\lambda$  be a weighted 3-path suspension of  $G_\omega$  that satisfies the conditions from Notation 3.2.2. Let  $I := I_{3,f}((\Sigma_3 G)_\lambda)$  and  $\underline{n} \in \mathbb{N}^d$ . Let  $\mathfrak{P} := (V'', \delta'')$  with  $V'' \subseteq V((\Sigma_3 G)_\lambda)$  and  $\delta'' : V'' \rightarrow \mathbb{N}$  be such that  $P(V'', \delta'')$  occurs in an m-irreducible decomposition of  $p_{\underline{n}}(I)$  and  $P(V'' \setminus \{v_{i,j}\}, \delta''|_{V'' \setminus \{v_{i,j}\}})$  does not occur in any m-irreducible decomposition of  $p_{\underline{n}}(I)$  for any  $v_{i,j} \in V''$ . Assume that  $v_{i,2}v_{i,1}v_{i,0}v_{j_1,0} \in \mathfrak{P}_{i,2}$  for a  $v_{i,0}v_{j_1,0} \in E(G)$ , then  $v_{k,0}v_{i,0}v_{p_1,0}v_{p_2,q_2} \notin \mathfrak{P}_{i,0}$  for any 3-path  $v_{k,0}v_{i,0}v_{p_1,0}v_{p_2,q_2}$  in  $G$  such that  $k \neq j_1 \neq p_1$  and  $v_{j_1,0} = v_{p_2,q_2}$ .

*Proof.* Proof by contradiction: assume that  $v_{k,0}v_{i,0}v_{p_1,0}v_{p_2,q_2} \in \mathfrak{P}_{i,0}$  for a 3-path  $v_{k,0}v_{i,0}v_{p_1,0}v_{p_2,q_2}$  in  $G$  such that  $k \neq j_1 \neq p_1$  and  $v_{j_1,0} = v_{p_2,q_2}$ . Then  $v_{i,0}v_{p_1,0}v_{j_1,0}v_{i,0}$  is a 3-cycle in  $G_\omega$ .

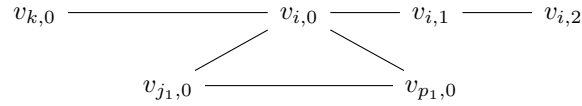

Since  $v_{i,0} \not\sim v_{i,2}v_{i,1}v_{i,0}v_{j_1,0}$ , we have that  $v_{i,0} \not\sim v_{k,0}v_{i,0}v_{j_1,0}v_{p_1,0}$  by Notation 3.2.2(c). Since  $v_{k,0} \not\sim v_{k,0}v_{i,0}v_{p_1,0}v_{p_2,q_2}$ , we have that  $v_{k,0} \not\sim v_{k,0}v_{i,0}v_{j_1,0}v_{p_1,0}$ . Since  $v_{i,0} \not\sim v_{i,2}v_{i,1}v_{i,0}v_{j_1,0}$  and  $v_{i,0} \smile v_{k,0}v_{i,0}v_{j_1,0}v_{p_1,0}$ , we have

$$f(\lambda(v_{i,1}v_{i,0}), \lambda(v_{i,0}v_{j_1,0})) < \delta''(v_{i,0}) \leq f(\lambda(v_{k,0}v_{i,0}), \lambda(v_{i,0}v_{p_1,0})).$$

By Notation 3.2.2(e)(1), we have that  $f(\lambda(v_{j_1,0}v_{i,0}), \lambda(v_{j_1,0}v_{j_1,p_1})) \leq \max\{\lambda(v_{j_1,0}v_{i,0}), \lambda(v_{j_1,0}v_{j_1,p_1})\}$  and  $f(\lambda(v_{p_1,0}v_{j_1,0}), \lambda(v_{p_1,0}v_{i,0})) \geq \lambda(v_{p_1,0}v_{j_1,0})$ . Hence similar to the proof of Proposition 3.2.7,  $v_{j_1,0}, v_{p_1,0} \not\sim v_{k,0}v_{i,0}v_{j_1,0}v_{p_1,0}$ , contradicting Lemma 3.1.26.  $\square$

**Proposition 3.2.11.** Let  $(\Sigma_3 G)_\lambda$  be a weighted 3-path suspension of  $G_\omega$  that satisfies the conditions from Notation 3.2.2. Let  $I := I_{3,f}((\Sigma_3 G)_\lambda)$  and  $\underline{n} \in \mathbb{N}^d$ . Let  $\mathfrak{P} := (V'', \delta'')$  with  $V'' \subseteq V((\Sigma_3 G)_\lambda)$  and  $\delta'' : V'' \rightarrow \mathbb{N}$  be such that  $P(V'', \delta'')$  occurs in an m-irreducible decomposition of  $p_{\underline{n}}(I)$  and  $P(V'' \setminus \{v_{i,j}\}, \delta''|_{V'' \setminus \{v_{i,j}\}})$  does not occur in any m-irreducible decomposition of  $p_{\underline{n}}(I)$  for any  $v_{i,j} \in V''$ . Assume that  $v_{i,2}v_{i,1}v_{i,0}v_{j_1,0} \in \mathfrak{P}_{i,2}$  for some  $v_{i,0}v_{j_1,0} \in E(G)$ , then  $(v_{i,0}v_{p_1,0}v_{p_1,1}v_{p_1,2} \rightsquigarrow v_{i,0}v_{p_1,1}v_{p_1,0}) \notin \mathfrak{P}_{i,0}$  for any  $v_{i,0}v_{p_1,0} \in E(G)$  such that  $p_1 \neq j_1$ .

*Proof.* Proof by contradiction: assume that  $(v_{i,0}v_{p_1,0}v_{p_1,1}v_{p_1,2} \rightsquigarrow v_{i,0}v_{p_1,1}v_{p_1,0}) \in \mathfrak{P}_{i,0}$  for some  $v_{i,0}v_{p_1,0} \in E(G)$  such that  $p_1 \neq j_1$ .

$$\begin{array}{ccccc} v_{i,2} & \text{---} & v_{i,1} & & v_{p_1,1} \\ & & | & & | \\ v_{j_1,0} & \text{---} & v_{i,0} & \text{---} & v_{p_1,0} \end{array}$$

By Notation 3.2.2(b) we have

$$\lambda(v_{p_1,0}v_{p_1,1}) \leq f(\lambda(v_{p_1,0}v_{p_1,1}), \lambda(v_{p_1,1}v_{p_1,2})) < f(\lambda(v_{p_1,0}v_{p_1,1}), \lambda(v_{p_1,1}v_{p_1,2})) + \lambda(v_{p_1,1}v_{p_1,2}).$$

So we have that  $v_{p_1,1} \not\sim v_{j_1,0}v_{i,0}v_{p_1,0}v_{p_1,1}$ . Also, we have that  $v_{i,0} \not\sim v_{j_1,0}v_{i,0}v_{p_1,0}v_{p_1,1}$  by Notation 3.2.2(c), and  $v_{j_1,0}, v_{p_1,0} \not\sim v_{j_1,0}v_{i,0}v_{p_1,0}v_{p_1,1}$ , contradicting Lemma 3.1.26.  $\square$

**Proposition 3.2.12.** Let  $(\Sigma_3 G)_\lambda$  be a weighted 3-path suspension of  $G_\omega$  that satisfies the conditions from Notation 3.2.2. Let  $I := I_{3,f}((\Sigma_3 G)_\lambda)$  and  $\underline{n} \in \mathbb{N}^d$ . Let  $\mathfrak{P} := (V'', \delta'')$  with  $V'' \subseteq V((\Sigma_3 G)_\lambda)$  and  $\delta'' : V'' \rightarrow \mathbb{N}$  be such that  $P(V'', \delta'')$  occurs in an m-irreducible decomposition of  $p_{\underline{n}}(I)$  and  $P(V'' \setminus \{v_{i,j}\}, \delta''|_{V'' \setminus \{v_{i,j}\}})$  does not occur in any m-irreducible decomposition of  $p_{\underline{n}}(I)$  for any  $v_{i,j} \in V''$ . Assume that  $v_{i,2}v_{i,1}v_{i,0}v_{j_1,0} \in \mathfrak{P}_{i,2}$  for some  $v_{i,0}v_{j_1,0} \in E(G)$ , then  $(v_{i,0}v_{p_1,0}v_{p_1,1}v_{p_1,2} \rightsquigarrow v_{i,0}v_{p_1,0}) \notin \mathfrak{P}_{i,0}$  for any  $v_{i,0}v_{p_1,0} \in E(G)$  such that  $p_1 \neq j_1$ .

*Proof.* Proof by contradiction: assume that we have  $(v_{i,0}v_{p_1,0}v_{p_1,1}v_{p_1,2} \rightsquigarrow v_{i,0}v_{p_1,0}) \in \mathfrak{P}_{i,0}$  for some  $v_{i,0}v_{p_1,0} \in E(G)$  such that  $p_1 \neq j_1$ .

$$\begin{array}{ccccc} v_{i,2} & \text{---} & v_{i,1} & & \\ & & | & & \\ v_{j_1,0} & \text{---} & v_{i,0} & \text{---} & v_{p_1,0} \end{array}$$

By Notation 3.2.2(b) we have that

$$\begin{aligned} & f(\lambda(v_{i,0}v_{p_1,0}), \lambda(v_{p_1,0}v_{p_1,1})) + \lambda(v_{p_1,0}v_{p_1,1}) \\ & \leq f(\lambda(v_{i,0}v_{p_1,0}), \lambda(v_{p_1,0}v_{p_1,1})) + f(\lambda(v_{p_1,0}v_{p_1,1}), \lambda(v_{p_1,1}v_{p_1,2})) \\ & < f(\lambda(v_{i,0}v_{p_1,0}), \lambda(v_{p_1,0}v_{p_1,1})) + f(\lambda(v_{p_1,0}v_{p_1,1}), \lambda(v_{p_1,1}v_{p_1,2})) + \lambda(v_{p_1,1}v_{p_1,2}), \end{aligned}$$

we have that  $v_{p_1,0} \not\sim (v_{j_1,0}v_{i,0}v_{p_1,0}v_{p_1,1} \rightsquigarrow v_{j_1,0}v_{i,0}v_{p_1,0})$ . Also, note that  $v_{i,0} \not\sim (v_{j_1,0}v_{i,0}v_{p_1,0}v_{p_1,1} \rightsquigarrow$

$v_{j_1,0}v_{i,0}v_{p_1,0}$ ) by Notation 3.2.2(c), and  $v_{j_1,0} \not\sim (v_{j_1,0}v_{i,0}v_{p_1,0}v_{p_1,1} \rightsquigarrow v_{j_1,0}v_{i,0}v_{p_1,0})$ , contradicting Lemma 3.1.26.  $\square$

**Proposition 3.2.13.** Let  $(\Sigma_3 G)_\lambda$  be a weighted 3-path suspension of  $G_\omega$  that satisfies the conditions from Notation 3.2.2. Let  $I := I_{3,f}((\Sigma_3 G)_\lambda)$  and  $\underline{n} \in \mathbb{N}^d$ . Let  $\mathfrak{P} := (V'', \delta'')$  with  $V'' \subseteq V((\Sigma_3 G)_\lambda)$  and  $\delta'' : V'' \rightarrow \mathbb{N}$  be such that  $P(V'', \delta'')$  occurs in an m-irreducible decomposition of  $p_{\underline{n}}(I)$  and  $P(V'' \setminus \{v_{i,j}\}, \delta''|_{V'' \setminus \{v_{i,j}\}})$  does not occur in any m-irreducible decomposition of  $p_{\underline{n}}(I)$  for any  $v_{i,j} \in V''$ . Assume that  $v_{i,2}v_{i,1}v_{i,0}v_{j_1,0} \in \mathfrak{P}_{i,2}$  for some  $v_{i,0}v_{j_1,0} \in E(G)$ , then  $(v_{i,0}v_{p_1,0}v_{p_2,0}v_{p_2,1} \rightsquigarrow v_{i,0}v_{p_1,0}v_{p_2,0}) \notin \mathfrak{P}_{i,0}$  for any 2-path  $v_{i,0}v_{p_1,0}v_{p_2,0}$  in  $G$  such that  $p_1 \neq j_1 \neq p_2$ .

*Proof.* Proof by contradiction: assume that  $(v_{i,0}v_{p_1,0}v_{p_2,0}v_{p_2,1} \rightsquigarrow v_{i,0}v_{p_1,0}v_{p_2,0}) \in \mathfrak{P}_{i,0}$  for some 2-path  $v_{i,0}v_{p_1,0}v_{p_2,0}$  in  $G$  such that  $p_1 \neq j_1 \neq p_2$ .

$$\begin{array}{ccccccc}
 & & v_{i,2} & & & & \\
 & & | & & & & \\
 & & v_{i,1} & & & & \\
 & & | & & & & \\
 v_{j_1,0} & \text{---} & v_{i,0} & \text{---} & v_{p_1,0} & \text{---} & v_{p_2,0}
 \end{array}$$

By Notation 3.2.2(a),

$$\lambda(v_{p_1,0}v_{p_2,0}) \leq f(\lambda(v_{p_1,0}v_{p_2,0}), \lambda(v_{p_2,0}v_{p_2,1})) < f(\lambda(v_{p_1,0}v_{p_2,0}), \lambda(v_{p_2,0}v_{p_2,1})) + \lambda(v_{p_2,0}v_{p_2,1}).$$

So we have that  $v_{p_2,0} \not\sim v_{j_1,0}v_{i,0}v_{p_1,0}v_{p_2,0}$ . Also, we have that  $v_{i,0} \not\sim v_{j_1,0}v_{i,0}v_{p_1,0}v_{p_2,0}$  by Notation 3.2.2(c), and  $v_{j_1,0}, v_{p_1,0} \not\sim v_{j_1,0}v_{i,0}v_{p_1,0}v_{p_2,0}$ , contradicting Lemma 3.1.26.  $\square$

**Proposition 3.2.14.** Let  $(\Sigma_3 G)_\lambda$  be a weighted 3-path suspension of  $G_\omega$  that satisfies the conditions from Notation 3.2.2. Let  $I := I_{3,f}((\Sigma_3 G)_\lambda)$  and  $\underline{n} \in \mathbb{N}^d$ . Let  $\mathfrak{P} := (V'', \delta'')$  with  $V'' \subseteq V((\Sigma_3 G)_\lambda)$  and  $\delta'' : V'' \rightarrow \mathbb{N}$  be such that  $P(V'', \delta'')$  occurs in an m-irreducible decomposition of  $p_{\underline{n}}(I)$  and  $P(V'' \setminus \{v_{i,j}\}, \delta''|_{V'' \setminus \{v_{i,j}\}})$  does not occur in any m-irreducible decomposition of  $p_{\underline{n}}(I)$  for any  $v_{i,j} \in V''$ . Assume that  $v_{i,2}v_{i,1}v_{i,0}v_{j_1,0} \in \mathfrak{P}_{i,2}$  for some  $v_{i,0}v_{j_1,0} \in E(G)$ , then  $(v_{i,0}v_{p_1,0}v_{p_2,0}v_{p_2,1} \rightsquigarrow v_{i,0}v_{p_1,0}v_{p_2,0}) \notin \mathfrak{P}_{i,0}$  for any 2-path  $v_{i,0}v_{p_1,0}v_{p_2,0}$  in  $G$  such that  $p_1 \neq j_1 = p_2$ .

*Proof.* Proof by contradiction: assume that  $(v_{i,0}v_{p_1,0}v_{p_2,0}v_{p_2,1} \rightsquigarrow v_{i,0}v_{p_1,0}v_{p_2,0}) \in \mathfrak{P}_{i,0}$  for some

2-path  $v_{i,0}v_{p_1,0}v_{p_2,0}$  in  $G$  such that  $p_1 \neq j_1 = p_2$ .

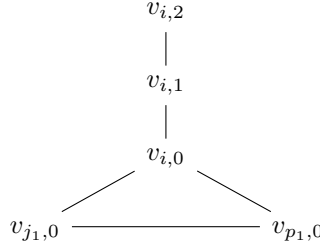

By Notation 3.2.2(a),

$$\lambda(v_{i,0}v_{j_1,0}) \leq f(\lambda(v_{j_1,1}v_{j_1,0}), \lambda(v_{j_1,0}v_{i,0})) < f(\lambda(v_{j_1,1}v_{j_1,0}), \lambda(v_{j_1,0}v_{i,0})) + \lambda(v_{j_1,1}v_{j_1,2}).$$

So we have that  $v_{j_1,0} \not\sim (v_{j_1,1}v_{j_1,0}v_{i,0}v_{i,1} \rightsquigarrow v_{j_1,0}v_{i,0}v_{i,1})$ . Additionally, we also have that  $v_{i,1}, v_{i,0} \not\sim (v_{j_1,1}v_{j_1,0}v_{i,0}v_{i,1} \rightsquigarrow v_{j_1,0}v_{i,0}v_{i,1})$ , contradicting Lemma 3.1.26.  $\square$

**Proposition 3.2.15.** Let  $(\Sigma_3 G)_\lambda$  be a weighted 3-path suspension of  $G_\omega$  that satisfies the conditions from Notation 3.2.2. Let  $I := I_{3,f}((\Sigma_3 G)_\lambda)$  and  $\underline{n} \in \mathbb{N}^d$ . Let  $\mathfrak{P} := (V'', \delta'')$  with  $V'' \subseteq V((\Sigma_3 G)_\lambda)$  and  $\delta'' : V'' \rightarrow \mathbb{N}$  be such that  $P(V'', \delta'')$  occurs in an m-irreducible decomposition of  $p_{\underline{n}}(I)$  and  $P(V'' \setminus \{v_{i,j}\}, \delta''|_{V'' \setminus \{v_{i,j}\}})$  does not occur in any m-irreducible decomposition of  $p_{\underline{n}}(I)$  for any  $v_{i,j} \in V''$ . Assume that  $v_{i,2}v_{i,1}v_{i,0}v_{j_1,0} \in \mathfrak{P}_{i,2}$  for a  $v_{i,0}v_{j_1,0} \in E(G)$ , then  $v_{i,0}v_{p_1,0}v_{p_2,0}v_{p_3,0} \notin \mathfrak{P}_{i,0}$  for any 3-path  $v_{i,0}v_{p_1,0}v_{p_2,0}v_{p_3,0}$  in  $\Sigma_3 G$  such that  $p_1 \neq j_1$ .

*Proof.* Proof by contradiction: assume that  $v_{i,0}v_{p_1,0}v_{p_2,0}v_{p_3,0} \in \mathfrak{P}_{i,0}$  such that  $p_1 \neq j_1$ .

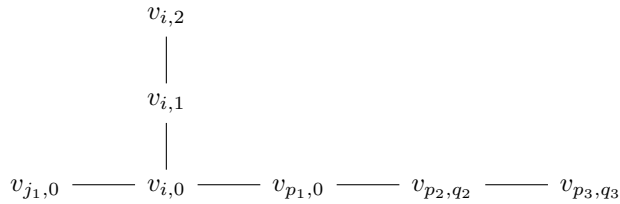

Then  $v_{p_1,0} \not\sim v_{j_1,0}v_{i,0}v_{p_1,0}v_{p_2,0}$  and  $v_{p_2,0} \not\sim v_{i,0}v_{p_1,0}v_{p_2,0}v_{p_3,0}$ . Since  $v_{i,2}v_{i,1}v_{i,0}v_{j_1,0} \in \mathfrak{P}_{i,2}$ , we have that  $v_{j_1,0}, v_{i,0} \not\sim v_{j_1,0}v_{i,0}v_{p_1,0}v_{p_2,0}$  by Notation 3.2.2(c). So we have that  $v_{p_2,0} \sim v_{j_1,0}v_{i,0}v_{p_1,0}v_{p_2,0}$  by Lemma 3.1.26. Hence

$$f(\lambda(v_{p_1,0}v_{p_2,0}), \lambda(v_{p_2,0}v_{p_3,0})) < \delta''(v_{p_2,0}) \leq \lambda(v_{p_1,0}v_{p_2,0}).$$

Thus, by Notation 3.2.2(b) we have that  $q_2 = 0$  and then  $q_3 = 0$  by Notation 3.2.2(a). Since  $v_{i,0} \smile v_{i,0}v_{p_1,0}v_{p_2,q_2}v_{p_3,q_3}$  and  $v_{i,0} \not\smile v_{i,2}v_{i,1}v_{i,0}v_{j_1,0}$ , we have that  $f(\lambda(v_{i,1}v_{i,0}), \lambda(v_{i,0}v_{j_1,0})) < \lambda(v_{i,0}v_{p_1,0})$ .

(a) Assume that  $p_2 \neq j_1 \neq p_3$ . Then  $v_{j_1,0}v_{i,0}v_{p_1,0}v_{p_2,q_2}v_{p_3,q_3}$  is a 4-path in  $G$ . So by Notations 3.2.2(d) and (c) we have

$$\lambda(v_{i,0}v_{p_1,0}) \leq f(\lambda(v_{j_1,0}v_{i,0}), \lambda(v_{i,0}v_{p_1,0})) \leq f(\lambda(v_{i,1}v_{i,0}), \lambda(v_{i,0}v_{j_1,0})),$$

contradicting  $f(\lambda(v_{i,1}v_{i,0}), \lambda(v_{i,0}v_{j_1,0})) < \lambda(v_{i,0}v_{p_1,0})$ .

(b) Assume that  $j_1 = p_2$ .

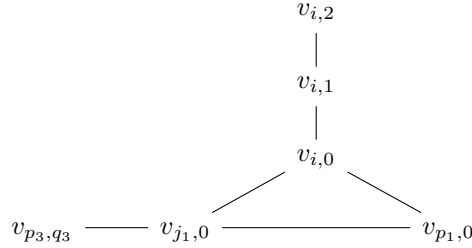

Then by Notation 3.2.2(e)(2)(i), we have that  $v_{p_1,0} \not\smile v_{p_3,q_3}v_{j_1,0}v_{i,0}v_{p_1,0}$ . Observe that  $v_{p_3,q_3}, v_{i,0} \not\smile v_{p_3,q_3}v_{j_1,0}v_{i,0}v_{p_1,0}$  and  $v_{i,1}, v_{i,0} \not\smile v_{i,1}v_{i,0}v_{j_1,0}v_{p_1,0}$ . By Notation 3.2.2(e)(2)(ii), we have that  $v_{j_1,0} \not\smile v_{p_3,q_3}v_{j_1,0}v_{i,0}v_{p_1,0}$ , contradicting Lemma 3.1.26.

(c) Assume that  $j_1 = p_3$ . Then  $v_{i,0}v_{j_1,0}v_{p_2,0}v_{p_1,0}v_{i,0}$  is a 4-cycle in  $G$ .

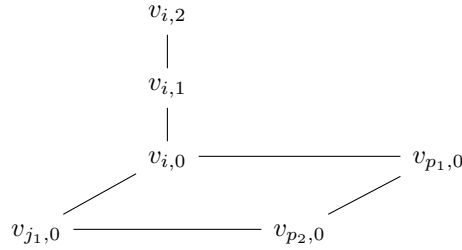

So we have the following 3 cases:

(1)  $f(\lambda(v_{p_2,0}v_{j_1,0}), \lambda(v_{p_2,0}v_{p_1,0})) \geq \lambda(v_{p_2,0}v_{p_1,0})$  by Notation 3.2.2(f)(1) or (f)(2)(iii). Then we have that  $v_{p_2,0} \not\smile v_{j_1,0}v_{i,0}v_{p_1,0}v_{p_2,0}$ . But  $v_{j_1,0}, v_{i,0}, v_{p_1,0} \not\smile v_{j_1,0}v_{i,0}v_{p_1,0}v_{p_2,0}$ , contradicting Lemma 3.1.26.

(2)  $f(\lambda(v_{j_1,0}v_{i,0}), \lambda(v_{j_1,0}v_{p_2,0})) \leq \max\{\lambda(v_{j_1,0}v_{i,0}), \lambda(v_{j_1,0}v_{p_2,0})\}$  and

$$f(\lambda(v_{p_1,0}v_{i,0}), \lambda(v_{p_1,0}v_{p_2,0})) \geq \lambda(v_{p_1,0}v_{p_2,0}),$$

by Notations 3.2.2(f)(2)(ii) and (f)(2)(iii). Then we have that  $v_{j_1,0} \not\sim v_{i,0}v_{j_1,0}v_{p_2,0}v_{p_1,0}$  and  $v_{p_1,0} \not\sim v_{i,0}v_{j_1,0}v_{p_2,0}v_{p_1,0}$ . But  $v_{i,0}, v_{p_2,0} \not\sim v_{i,0}v_{j_1,0}v_{p_2,0}v_{p_1,0}$ , contradicting Lemma 3.1.26.

(3)  $f(\lambda(v_{j_1,0}v_{i,0}), \lambda(v_{j_1,0}v_{p_2,0})) \leq \max\{\lambda(v_{j_1,0}v_{i,0}), \lambda(v_{j_1,0}v_{p_2,0})\}$  and

$$f(\lambda(v_{p_2,0}v_{j_1,0}), \lambda(v_{p_2,0}v_{p_1,0})) \geq \lambda(v_{p_2,0}v_{j_1,0}) \text{ and } f(\lambda(v_{p_1,0}v_{i,0}), \lambda(v_{p_1,0}v_{p_2,0})) \geq \lambda(v_{p_1,0}v_{i,0}),$$

by Notations 3.2.2(f)(2)(ii) and (f)(2)(iii). Then  $v_{j_1,0} \not\sim v_{p_2,0}v_{j_1,0}v_{i,0}v_{p_1,0}$ ,  $v_{p_2,0} \not\sim v_{p_2,0}v_{j_1,0}v_{i,0}v_{p_1,0}$  and  $v_{p_1,0} \not\sim v_{p_2,0}v_{j_1,0}v_{i,0}v_{p_1,0}$ . But  $v_{i,0} \not\sim v_{p_2,0}v_{j_1,0}v_{i,0}v_{p_1,0}$ , contradicting Lemma 3.1.26.  $\square$

**Proposition 3.2.16.** Let  $(\Sigma_3 G)_\lambda$  be a weighted 3-path suspension of  $G_\omega$  that satisfies the conditions from Notation 3.2.2. Let  $I := I_{3,f}((\Sigma_3 G)_\lambda)$  and  $\underline{n} \in \mathbb{N}^d$ . Let  $\mathfrak{P} := (V'', \delta'')$  with  $V'' \subseteq V((\Sigma_3 G)_\lambda)$  and  $\delta'' : V'' \rightarrow \mathbb{N}$  be such that  $P(V'', \delta'')$  occurs in an m-irreducible decomposition of  $p_{\underline{n}}(I)$  and  $P(V'' \setminus \{v_{i,j}\}, \delta''|_{V'' \setminus \{v_{i,j}\}})$  does not occur in any m-irreducible decomposition of  $p_{\underline{n}}(I)$  for any  $v_{i,j} \in V''$ . Then for  $i = 1, \dots, d$ , we have  $v_{i,0} \notin V''$  or  $v_{i,2} \notin V''$ .

*Proof.* Proof by contradiction: assume that  $v_{i,0} \in V''$  and  $v_{i,2} \in V''$ . Then similar to the proof of Proposition 3.2.4,  $v_{i,3}v_{i,2}v_{i,1}v_{i,0}, (v_{i,3}v_{i,2}v_{i,1}v_{i,0} \rightsquigarrow v_{i,2}v_{i,1}v_{i,0}) \notin \mathfrak{P}_{i,2}$ . Then  $v_{i,2}v_{i,1}v_{i,0}v_{j_1,0} \in \mathfrak{P}_{i,2}$  for some  $v_{i,0}v_{j_1,0} \in E(G)$ . Then one can check that  $(P_r \rightsquigarrow \wp) \notin \mathfrak{P}_{i,0}$  for any path  $\wp$  in  $p_{\underline{n}}(I)$  with  $v_{i,0}, v_{j_1,0} \in V(\wp)$  or with  $v_{i,0}, v_{i,2} \in V(\wp)$ . Combining  $v_{i,2}v_{i,1}v_{i,0}v_{j_1,0} \in \mathfrak{P}_{i,2}$  with Propositions 3.2.5 to 3.2.15, we have  $\mathfrak{P}_{i,0} = \emptyset$ , contradicting Lemma 3.1.26.  $\square$

**Proposition 3.2.17.** Let  $(\Sigma_3 G)_\lambda$  be a weighted 3-path suspension of  $G_\omega$  that satisfies the conditions from Notation 3.2.2. Let  $I := I_{3,f}((\Sigma_3 G)_\lambda)$  and  $\underline{n} \in \mathbb{N}^d$ . Let  $\mathfrak{P} := (V'', \delta'')$  with  $V'' \subseteq V((\Sigma_3 G)_\lambda)$  and  $\delta'' : V'' \rightarrow \mathbb{N}$  be such that  $P(V'', \delta'')$  occurs in an m-irreducible decomposition of  $p_{\underline{n}}(I)$  and  $P(V'' \setminus \{v_{i,j}\}, \delta''|_{V'' \setminus \{v_{i,j}\}})$  does not occur in any m-irreducible decomposition of  $p_{\underline{n}}(I)$  for any  $v_{i,j} \in V''$ . Assume that  $v_{i,2}v_{i,1}v_{i,0}v_{j_1,0} \in \mathfrak{P}_{i,1}$  for some  $v_{i,0}v_{j_1,0} \in E(G)$ , then  $\mathfrak{P}_{i,0} = \emptyset$ .

*Proof.* One can check that  $(P_r \rightsquigarrow \wp) \notin \mathfrak{P}_{i,0}$  for any path  $\wp$  in  $p_{\underline{n}}(I)$  with  $v_{i,0}, v_{j_1,0} \in V(\wp)$  or with  $v_{i,0}, v_{i,2} \in V(\wp)$ . So one can also check that the remaining 11 cases are identical to the ones in Proposition 3.2.5 to 3.2.15 and their corresponding proofs.  $\square$

**Proposition 3.2.18.** Let  $(\Sigma_3 G)_\lambda$  be a weighted 3-path suspension of  $G_\omega$  that satisfies the conditions from Notation 3.2.2. Let  $I := I_{3,f}((\Sigma_3 G)_\lambda)$  and  $\underline{n} \in \mathbb{N}^d$ . Let  $\mathfrak{P} := (V'', \delta'')$  with  $V'' \subseteq V((\Sigma_3 G)_\lambda)$  and  $\delta'' : V'' \rightarrow \mathbb{N}$  be such that  $P(V'', \delta'')$  occurs in an m-irreducible decomposition of  $p_{\underline{n}}(I)$  and  $P(V'' \setminus \{v_{i,j}\}, \delta''|_{V'' \setminus \{v_{i,j}\}})$  does not occur in any m-irreducible decomposition of  $p_{\underline{n}}(I)$  for any  $v_{i,j} \in V''$ . Assume that  $(v_{i,1}v_{i,0}v_{j_1,0}v_{j_1,1} \rightsquigarrow v_{i,1}v_{i,0}v_{j_1,0}) \in \mathfrak{P}_{i,1}$ , then  $\mathfrak{P}_{i,0} = \emptyset$ .

*Proof.* Note that  $\varphi \notin \mathfrak{P}_{i,0}$  for any path  $\varphi$  in  $p_{\underline{n}}(I)$  with  $v_{i,0}, v_{j_1,0} \in V(\varphi)$  or with  $v_{i,0}, v_{i,1} \in V(\varphi)$ .

(a) Assume that  $(v_{k,0}v_{i,0}v_{p_1,0}v_{p_1,1} \rightsquigarrow v_{k,0}v_{i,0}v_{p_1,0}) \in \mathfrak{P}_{i,0}$  for some  $k \neq j_1 \neq p_1$ .

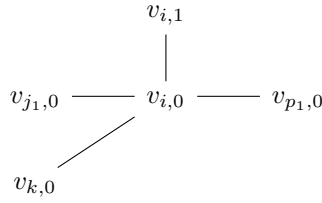

Then  $v_{j_1,0}, v_{k,0} \not\sim (v_{j_1,1}v_{j_1,0}v_{i,0}v_{k,0} \rightsquigarrow v_{j_1,0}v_{i,0}v_{k,0})$ . Also, we have that  $v_{i,0} \not\sim (v_{j_1,1}v_{j_1,0}v_{i,0}v_{k,0} \rightsquigarrow v_{j_1,0}v_{i,0}v_{k,0})$  by Notation 3.2.2(c), contradicting Lemma 3.1.26.

(b) Assume that  $v_{k,0}v_{i,0}v_{p_1,0}v_{p_2,q_2} \in \mathfrak{P}_{i,0}$  for some  $k \neq j_1 \neq p_1$ .

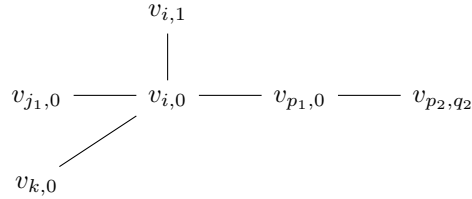

Then this case is similar to Case (a). Note that in this case, we may have that  $v_{j_2,k_2} = v_{p_2,q_2}$ .

(c) Assume that  $(v_{i,0}v_{p_1,0}v_{p_1,1}v_{p_1,2} \rightsquigarrow v_{i,0}v_{p_1,0}v_{p_1,1}) \in \mathfrak{P}_{i,0}$  or  $(v_{i,0}v_{p_1,0}v_{p_1,1}v_{p_1,2} \rightsquigarrow v_{i,0}v_{p_1,0}) \in \mathfrak{P}_{i,0}$  for some  $p_1 \neq j_1$ .

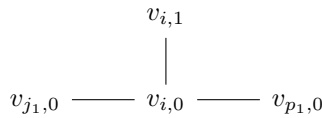

Then  $v_{p_1,0} \not\sim (v_{p_1,0}v_{i,0}v_{j_1,0}v_{j_1,1} \rightsquigarrow v_{p_1,0}v_{i,0}v_{j_1,0})$  by Notation 3.2.2(a). Also, note that  $v_{i,0} \not\sim (v_{p_1,0}v_{i,0}v_{j_1,0}v_{j_1,1} \rightsquigarrow v_{p_1,0}v_{i,0}v_{j_1,0})$  by Notation 3.2.2(c), and that  $v_{j_1,0} \not\sim (v_{p_1,0}v_{i,0}v_{j_1,0}v_{j_1,1} \rightsquigarrow v_{p_1,0}v_{i,0}v_{j_1,0})$ , contradicting Lemma 3.1.26.

(d) Assume that  $(v_{i,0}v_{p_1,0}v_{p_2,0}v_{p_2,1} \rightsquigarrow v_{i,0}v_{p_1,0}v_{p_2,0}) \in \mathfrak{P}_{i,0}$  for some  $p_1 \neq j_1 \neq p_2$ .

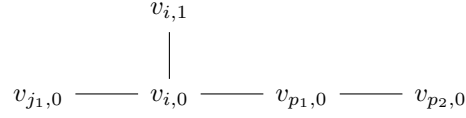

Then we have that  $v_{p_2,0} \not\prec v_{j_1,0}v_{i,0}v_{p_1,0}v_{p_2,0}$  by Notation 3.2.2(a), and  $v_{i,0} \not\prec v_{j_1,0}v_{i,0}v_{p_1,0}v_{p_2,0}$  by Notation 3.2.2(c) and  $v_{p_1,0}, v_{j_1,0} \not\prec v_{j_1,0}v_{i,0}v_{p_1,0}v_{p_2,0}$ , contradicting Lemma 3.1.26.

(e) Assume that  $(v_{i,0}v_{p_1,0}v_{p_2,0}v_{p_2,1} \rightsquigarrow v_{i,0}v_{p_1,0}v_{p_2,0}) \in \mathfrak{P}_{i,0}$  for some  $p_1 \neq j_1 = p_2$ .

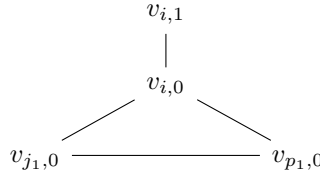

Since  $v_{i,0}v_{j_1,0}v_{p_1,0}v_{i,0}$  is a 3-cycle in  $G$  and  $f(\lambda(v_{i,1}v_{i,0}), \lambda(v_{i,0}v_{j_1,0})) < \lambda(v_{i,0}v_{p_1,0})$ , we have that  $f(\lambda(v_{p_1,0}v_{i,0}), \lambda(v_{p_1,0}v_{j_1,0})) \geq \lambda(v_{p_1,0}v_{i,0})$ . So we have  $v_{p_1,0} \not\prec (v_{p_1,0}v_{i,0}v_{j_1,0}v_{j_1,1} \rightsquigarrow v_{p_1,0}v_{i,0}v_{j_1,0})$ . Since  $v_{j_1,0} \not\prec (v_{i,1}v_{i,0}v_{j_1,0}v_{j_1,1} \rightsquigarrow v_{i,1}v_{i,0}v_{j_1,0})$ , we have  $v_{j_1,0} \not\prec (v_{p_1,0}v_{i,0}v_{j_1,0}v_{j_1,1} \rightsquigarrow v_{p_1,0}v_{i,0}v_{j_1,0})$ . Also, we have that  $v_{i,0} \not\prec (v_{p_1,0}v_{i,0}v_{j_1,0}v_{j_1,1} \rightsquigarrow v_{p_1,0}v_{i,0}v_{j_1,0})$  by Notation 3.2.2(c). Hence we have that  $v_{p_1,0}, v_{i,0}, v_{j_1,0} \not\prec (v_{p_1,0}v_{i,0}v_{j_1,0}v_{j_1,1} \rightsquigarrow v_{p_1,0}v_{i,0}v_{j_1,0})$ , contradicting Lemma 3.1.26.

(f) Assume that  $v_{i,0}v_{p_1,0}v_{p_2,q_2}v_{p_3,q_3} \in \mathfrak{P}_{i,0}$  for some  $j_1 \neq p_1$  and  $v_{p_2,q_2} \neq v_{j_1,0} \neq v_{p_3,q_3}$ .

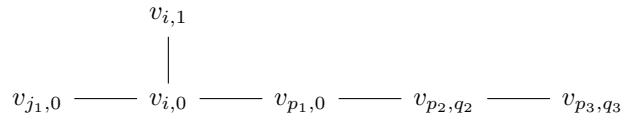

By way of contradiction, we get that  $v_{j_1,0}, v_{i,0}, v_{p_1,0} \not\prec v_{j_1,0}v_{i,0}v_{p_1,0}v_{p_2,q_2}$ , so we have that  $v_{p_2,q_2} \smile v_{j_1,0}v_{i,0}v_{p_1,0}v_{p_2,q_2}$ . Since  $v_{p_2,q_2} \not\prec v_{i,0}v_{p_1,0}v_{p_2,q_2}v_{p_3,q_3}$ , we have  $f(\lambda(v_{p_1,0}v_{p_2,q_2}), \lambda(v_{p_2,q_2}v_{p_3,q_3})) < \lambda(v_{p_1,0}v_{p_2,q_2})$ . So we have that  $q_3 = 0$  and then  $q_2 = 0$ . So we have that  $v_{j_1,0}v_{i,0}v_{p_1,0}v_{p_2,q_2}v_{p_3,q_3}$  is a 4-path in  $G$ . Hence by Notation 3.2.2(d),

$$f(\lambda(v_{j_1,0}v_{i,0}), \lambda(v_{i,0}v_{p_1,0})) \geq \lambda(v_{i,0}v_{p_1,0}) > f(\lambda(v_{i,1}v_{i,0}), \lambda(v_{i,0}v_{j_1,0})),$$

contradicting Notation 3.2.2(c).



(g) Assume that  $v_{i,0}v_{p_1,0}v_{p_2,q_2}v_{p_3,q_3} \in \mathfrak{P}_{i,0}$  for some  $v_{j_1,0} = v_{p_2,q_2}$ .

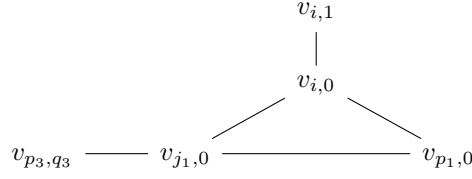

Then similar to Case (e), we have that  $v_{p_1,0}, v_{i,0}, v_{j_1,0} \not\prec (v_{p_1,0}v_{i,0}v_{j_1,0}v_{j_1,1} \rightsquigarrow v_{p_1,0}v_{i,0}v_{j_1,0})$ , contradicting Lemma 3.1.26.

(h) Assume that  $v_{i,0}v_{p_1,0}v_{p_2,q_2}v_{p_3,q_3} \in \mathfrak{P}_{i,0}$  for some  $v_{j_1,0} = v_{p_3,q_3}$ .

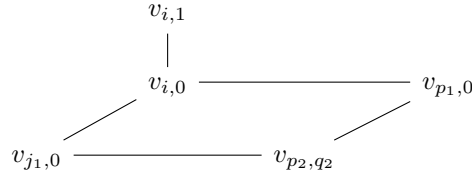

Since  $v_{i,0}v_{j_1,0}v_{p_2,q_2}v_{p_1,0}v_{i,0}$  is a 4-cycle in  $G$ , we have the following 2 cases by Notation 3.2.2(f):

(1)  $f(\lambda(v_{p_2,q_2}v_{j_1,0}), \lambda(v_{p_2,q_2}v_{p_1,0})) \geq \lambda(v_{p_2,q_2}v_{p_1,0})$  by Notation 3.2.2(f)(1). Then we have that  $v_{p_2,q_2} \not\prec v_{p_2,q_2}v_{p_1,0}v_{i,0}v_{j_1,0}$ . Since

$$\lambda(v_{j_1,1}v_{j_1,0}) + f(\lambda(v_{j_1,1}v_{j_1,0}), \lambda(v_{j_1,0}v_{i,0})) > f(\lambda(v_{j_1,1}v_{j_1,0}), \lambda(v_{j_1,0}v_{i,0})) \geq \lambda(v_{i,0}v_{j_1,0}),$$

by Notation 3.2.2(a), we have that  $v_{j_1,0} \not\prec v_{p_2,q_2}v_{p_1,0}v_{i,0}v_{j_1,0}$ . Also,  $v_{i,0} \not\prec v_{p_2,q_2}v_{p_1,0}v_{i,0}v_{j_1,0}$  by condition (c) and  $v_{p_1,0} \not\prec v_{p_2,q_2}v_{p_1,0}v_{i,0}v_{j_1,0}$ , contradicting Lemma 3.1.26.

(2)  $f(\lambda(v_{p_1,0}v_{i,0}), \lambda(v_{p_1,0}v_{p_2,q_2})) \geq \min\{\lambda(v_{p_1,0}v_{i,0}), \lambda(v_{p_1,0}v_{p_2,q_2})\}$  by Notation 3.2.2(f)(2)(i). As  $v_{j_1,0} \not\prec (v_{i,1}v_{i,0}v_{j_1,0}v_{j_1,1} \rightsquigarrow v_{i,1}v_{i,0}v_{j_1,0})$ , we have that  $v_{j_1,0} \not\prec (v_{p_1,0}v_{i,0}v_{j_1,0}v_{j_1,0} \rightsquigarrow v_{p_1,0}v_{i,0}v_{j_1,0})$ . Also, since  $v_{i,0} \not\prec (v_{p_1,0}v_{i,0}v_{j_1,0}v_{j_1,0} \rightsquigarrow v_{p_1,0}v_{i,0}v_{j_1,0})$  by Notation 3.2.2(c), we have that  $v_{p_1,0} \not\prec (v_{p_1,0}v_{i,0}v_{j_1,0}v_{j_1,0} \rightsquigarrow v_{p_1,0}v_{i,0}v_{j_1,0})$ . So we have that  $v_{p_1,0} \smile (v_{p_1,0}v_{i,0}v_{j_1,0}v_{j_1,0} \rightsquigarrow v_{p_1,0}v_{i,0}v_{j_1,0})$  by Lemma 3.1.26. So we have that  $v_{p_1,0} \not\prec v_{p_1,0}v_{p_2,q_2}v_{j_1,0}v_{i,0}$ . Since

$$\begin{aligned}
 f(\lambda(v_{i,0}v_{j_1,0}), \lambda(v_{j_1,0}v_{p_2,q_2})) &\leq f(\lambda(v_{j_1,1}v_{j_1,0}), \lambda(v_{j_1,0}v_{i,0})) \\
 &< \lambda(v_{j_1,1}v_{j_1,0}) + f(\lambda(v_{j_1,1}v_{j_1,0}), \lambda(v_{j_1,0}v_{i,0}))
 \end{aligned}$$

by Notation 3.2.2(c), we have that  $v_{j_1,0} \not\sim v_{p_1,0}v_{p_2,q_2}v_{j_1,0}v_{i,0}$ . Also,  $v_{i,0} \not\sim v_{p_1,0}v_{p_2,q_2}v_{j_1,0}v_{i,0}$  by Notation 3.2.2(a) and  $v_{p_2,q_2} \not\sim v_{p_1,0}v_{p_2,q_2}v_{j_1,0}v_{i,0}$ , contradicting Lemma 3.1.26.  $\square$

**Proposition 3.2.19.** Let  $(\Sigma_3 G)_\lambda$  be a weighted 3-path suspension of  $G_\omega$  that satisfies the conditions from Notation 3.2.2. Let  $I := I_{3,f}((\Sigma_3 G)_\lambda)$  and  $\underline{n} \in \mathbb{N}^d$ . Let  $\mathfrak{P} := (V'', \delta'')$  with  $V'' \subseteq V((\Sigma_3 G)_\lambda)$  and  $\delta'' : V'' \rightarrow \mathbb{N}$  be such that  $P(V'', \delta'')$  occurs in an m-irreducible decomposition of  $p_{\underline{n}}(I)$  and  $P(V'' \setminus \{v_{i,j}\}, \delta''|_{V'' \setminus \{v_{i,j}\}})$  does not occur in any m-irreducible decomposition of  $p_{\underline{n}}(I)$  for any  $v_{i,j} \in V''$ . Assume that  $v_{i,2}v_{i,1}v_{i,0}v_{j_1,0} \in \mathfrak{P}_{i,1}$  for some  $v_{i,0}v_{j_1,0} \in E(G)$ , then  $\wp \notin \mathfrak{P}_{i,0}$  for any path  $\wp \in p_{\underline{n}}(I)$  with  $v_{i,0}, v_{j_1,0} \in V(\wp)$  or with  $v_{i,0}, v_{i,1} \in V(\wp)$

*Proof.* It is straightforward to show this statement.  $\square$

**Proposition 3.2.20.** Let  $(\Sigma_3 G)_\lambda$  be a weighted 3-path suspension of  $G_\omega$  that satisfies the conditions from Notation 3.2.2. Let  $I := I_{3,f}((\Sigma_3 G)_\lambda)$  and  $\underline{n} \in \mathbb{N}^d$ . Let  $\mathfrak{P} := (V'', \delta'')$  with  $V'' \subseteq V((\Sigma_3 G)_\lambda)$  and  $\delta'' : V'' \rightarrow \mathbb{N}$  be such that  $P(V'', \delta'')$  occurs in an m-irreducible decomposition of  $p_{\underline{n}}(I)$  and  $P(V'' \setminus \{v_{i,j}\}, \delta''|_{V'' \setminus \{v_{i,j}\}})$  does not occur in any m-irreducible decomposition of  $p_{\underline{n}}(I)$  for any  $v_{i,j} \in V''$ . Assume that  $v_{i,1}v_{i,0}v_{j_1,0}v_{j_2,k_2} \in \mathfrak{P}_{i,1}$ , then  $(v_{k,0}v_{i,0}v_{p_1,0}v_{p_1,1} \rightsquigarrow v_{k,0}v_{i,0}v_{p_1,0}) \notin \mathfrak{P}_{i,0}$  for any  $v_{j_2,k_2} \neq v_{k,0} \neq v_{j_1,0}$  and  $j_1 \neq p_1$ .

*Proof.* Proof by contradiction: assume that  $(v_{k,0}v_{i,0}v_{p_1,0}v_{p_1,1} \rightsquigarrow v_{k,0}v_{i,0}v_{p_1,0}) \in \mathfrak{P}_{i,0}$  for some  $v_{j_2,k_2} \neq v_{k,0} \neq v_{j_1,0}$  and  $j_1 \neq p_1$ .

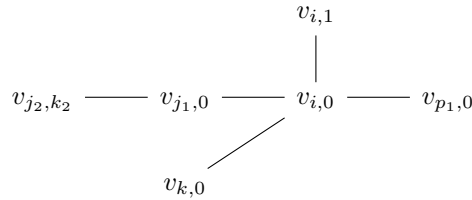

Then  $v_{j_2,k_2}, v_{j_1,0}, v_{k,0} \not\sim v_{j_2,k_2}v_{j_1,0}v_{i,0}v_{k,0}$ . Also, we have that  $v_{i,0} \not\sim v_{j_2,k_2}v_{j_1,0}v_{i,0}v_{k,0}$  by Notation 3.2.2(c), contradicting Lemma 3.1.26. Note that in this case, we may have that  $v_{j_2,k_2} = v_{p_1,0}$ .  $\square$

**Proposition 3.2.21.** Let  $(\Sigma_3 G)_\lambda$  be a weighted 3-path suspension of  $G_\omega$  that satisfies the conditions from Notation 3.2.2. Let  $I := I_{3,f}((\Sigma_3 G)_\lambda)$  and  $\underline{n} \in \mathbb{N}^d$ . Let  $\mathfrak{P} := (V'', \delta'')$  with  $V'' \subseteq V((\Sigma_3 G)_\lambda)$  and  $\delta'' : V'' \rightarrow \mathbb{N}$  be such that  $P(V'', \delta'')$  occurs in an m-irreducible decomposition of  $p_{\underline{n}}(I)$  and  $P(V'' \setminus \{v_{i,j}\}, \delta''|_{V'' \setminus \{v_{i,j}\}})$  does not occur in any m-irreducible decomposition of  $p_{\underline{n}}(I)$  for any

$v_{i,j} \in V''$ . Assume that  $v_{i,1}v_{i,0}v_{j_1,0}v_{j_2,k_2} \in \mathfrak{P}_{i,1}$ , then  $v_{k,0}v_{i,0}v_{p_1,0}v_{p_2,q_2} \notin \mathfrak{P}_{i,0}$  for any  $v_{j_2,k_2} \neq v_{k,0} \neq v_{j_1,0}$  and  $j_1 \neq p_1$ .

*Proof.* Proof by contradiction: assume that  $v_{k,0}v_{i,0}v_{p_1,0}v_{p_2,q_2} \in \mathfrak{P}_{i,0}$  for some  $v_{j_2,k_2} \neq v_{k,0} \neq v_{j_1,0}$  and  $j_1 \neq p_1$ .

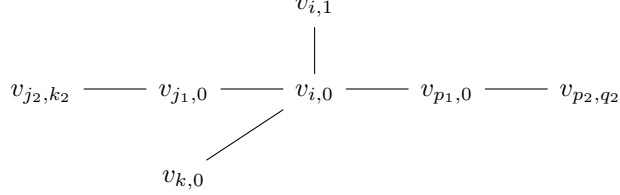

Then the proof is similar to the proof of Proposition 3.2.20. Note that in this case, we may have that  $v_{j_2,k_2} = v_{p_1,0}$ , etc.  $\square$

**Proposition 3.2.22.** Let  $(\Sigma_3 G)_\lambda$  be a weighted 3-path suspension of  $G_\omega$  that satisfies the conditions from Notation 3.2.2. Let  $I := I_{3,f}((\Sigma_3 G)_\lambda)$  and  $\underline{n} \in \mathbb{N}^d$ . Let  $\mathfrak{P} := (V'', \delta'')$  with  $V'' \subseteq V((\Sigma_3 G)_\lambda)$  and  $\delta'' : V'' \rightarrow \mathbb{N}$  be such that  $P(V'', \delta'')$  occurs in an m-irreducible decomposition of  $p_{\underline{n}}(I)$  and  $P(V'' \setminus \{v_{i,j}\}, \delta''|_{V'' \setminus \{v_{i,j}\}})$  does not occur in any m-irreducible decomposition of  $p_{\underline{n}}(I)$  for any  $v_{i,j} \in V''$ . Assume that  $v_{i,1}v_{i,0}v_{j_1,0}v_{j_2,k_2} \in \mathfrak{P}_{i,1}$ , then  $v_{k,0}v_{i,0}v_{p_1,0}v_{p_2,q_2} \notin \mathfrak{P}_{i,0}$  for any  $v_{j_2,k_2} = v_{k,0}$  and  $j_1 \neq p_1$  and  $v_{j_1,0} \neq v_{p_2,q_2}$ .

*Proof.* Proof by contradiction: assume that  $v_{k,0}v_{i,0}v_{p_1,0}v_{p_2,q_2} \in \mathfrak{P}_{i,0}$  for some  $v_{j_2,k_2} = v_{k,0}$  and  $j_1 \neq p_1$  and  $v_{j_1,0} \neq v_{p_2,q_2}$ .

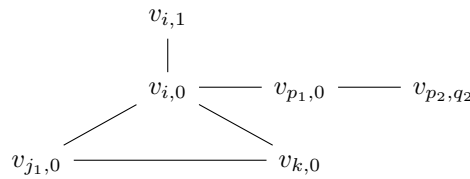

Then by way of contradiction, we get that  $v_{j_1,0} \smile v_{j_1,0}v_{i,0}v_{p_1,0}v_{p_2,q_2}$  and  $v_{p_1,0} \smile v_{p_1,0}v_{i,0}v_{j_1,0}v_{k,0}$ . Since  $v_{p_1,0} \not\smile v_{k,0}v_{i,0}v_{p_1,0}v_{p_2,q_2}$ , we have that  $f(\lambda(v_{i,0}v_{p_1,0}), \lambda(v_{p_1,0}v_{p_2,q_2})) < \lambda(v_{i,0}v_{p_1,0})$  and then  $q_2 = 0$ . So we have that  $v_{k,0}v_{j_1,0}v_{i,0}v_{p_1,0}v_{p_2,q_2}$  is a 4-path in  $G$ . Hence  $f(\lambda(v_{k,0}v_{j_1,0}), \lambda(v_{j_1,0}v_{i,0})) \geq \lambda(v_{j_1,0}v_{i,0})$ , contradicting  $v_{j_1,0} \smile v_{j_1,0}v_{i,0}v_{p_1,0}v_{p_2,q_2}$  and  $v_{j_1,0} \not\smile v_{i,1}v_{i,0}v_{j_1,0}v_{k,0}$ .  $\square$

**Proposition 3.2.23.** Let  $(\Sigma_3 G)_\lambda$  be a weighted 3-path suspension of  $G_\omega$  that satisfies the conditions from Notation 3.2.2. Let  $I := I_{3,f}((\Sigma_3 G)_\lambda)$  and  $\underline{n} \in \mathbb{N}^d$ . Let  $\mathfrak{P} := (V'', \delta'')$  with  $V'' \subseteq V((\Sigma_3 G)_\lambda)$  and  $\delta'' : V'' \rightarrow \mathbb{N}$  be such that  $P(V'', \delta'')$  occurs in an m-irreducible decomposition of  $p_{\underline{n}}(I)$  and

$P(V'' \setminus \{v_{i,j}\}, \delta''|_{V'' \setminus \{v_{i,j}\}})$  does not occur in any m-irreducible decomposition of  $p_{\underline{n}}(I)$  for any  $v_{i,j} \in V''$ . Assume that  $v_{i,1}v_{i,0}v_{j_1,0}v_{j_2,k_2} \in \mathfrak{P}_{i,1}$ , then  $v_{k,0}v_{i,0}v_{p_1,0}v_{p_2,q_2} \notin \mathfrak{P}_{i,0}$  for any  $v_{j_2,k_2} = v_{k,0}$  and  $j_1 \neq p_1$  and  $v_{j_1,0} = v_{p_2,q_2}$ .

*Proof.* Proof by contradiction: assume that  $v_{k,0}v_{i,0}v_{p_1,0}v_{p_2,q_2} \in \mathfrak{P}_{i,0}$  for some  $v_{j_2,k_2} = v_{k,0}$  and  $j_1 \neq p_1$  and  $v_{j_1,0} = v_{p_2,q_2}$ .

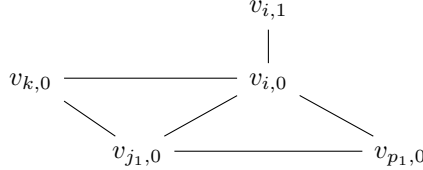

Then  $v_{k,0}, v_{j_1,0} \not\prec v_{k,0}v_{j_1,0}v_{i,0}v_{p_1,0}$ . Since  $f(\lambda(v_{k,0}v_{i,0}), \lambda(v_{i,0}v_{p_1,0})) > f(\lambda(v_{i,1}v_{i,0}), \lambda(v_{i,0}v_{j_1,0}))$  and  $v_{i,0}v_{j_1,0}v_{p_1,0}v_{i,0}$  is a 3-cycle in  $G$ , we have that  $f(\lambda(v_{p_1,0}v_{i,0}), \lambda(v_{p_1,0}v_{j_1,0})) \geq \lambda(v_{p_1,0}v_{i,0})$  by Notation 3.2.2(e)(1). So we have that  $v_{p_1,0} \not\prec v_{k,0}v_{j_1,0}v_{i,0}v_{p_1,0}$ . Also, we have that  $v_{i,0} \not\prec v_{k,0}v_{j_1,0}v_{i,0}v_{p_1,0}$  by Notation 3.2.2(c), contradicting Lemma 3.1.26.  $\square$

**Proposition 3.2.24.** Let  $(\Sigma_3 G)_\lambda$  be a weighted 3-path suspension of  $G_\omega$  that satisfies the conditions from Notation 3.2.2. Let  $I := I_{3,f}((\Sigma_3 G)_\lambda)$  and  $\underline{n} \in \mathbb{N}^d$ . Let  $\mathfrak{P} := (V'', \delta'')$  with  $V'' \subseteq V((\Sigma_3 G)_\lambda)$  and  $\delta'' : V'' \rightarrow \mathbb{N}$  be such that  $P(V'', \delta'')$  occurs in an m-irreducible decomposition of  $p_{\underline{n}}(I)$  and  $P(V'' \setminus \{v_{i,j}\}, \delta''|_{V'' \setminus \{v_{i,j}\}})$  does not occur in any m-irreducible decomposition of  $p_{\underline{n}}(I)$  for any  $v_{i,j} \in V''$ . Assume that  $v_{i,1}v_{i,0}v_{j_1,0}v_{j_2,k_2} \in \mathfrak{P}_{i,1}$ , then  $(v_{i,0}v_{p_1,0}v_{p_1,1}v_{p_1,2} \rightsquigarrow v_{i,0}v_{p_1,0}v_{p_1,1}) \notin \mathfrak{P}_{i,0}$  for any  $p_1 \neq j_1$  and  $v_{p_1,0} \neq v_{j_2,k_2}$ .

*Proof.* Proof by contradiction: assume that  $(v_{i,0}v_{p_1,0}v_{p_1,1}v_{p_1,2} \rightsquigarrow v_{i,0}v_{p_1,0}v_{p_1,1}) \in \mathfrak{P}_{i,0}$  for some  $p_1 \neq j_1$  and  $v_{p_1,0} \neq v_{j_2,k_2}$ .

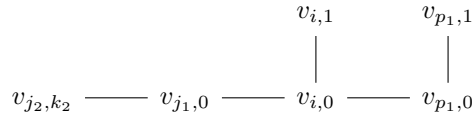

By Notation 3.2.2(a), we have  $v_{p_1,0} \not\prec v_{j_2,k_2}v_{j_1,0}v_{i,0}v_{p_1,0}$ . Also, note that  $v_{i,0} \not\prec v_{j_2,k_2}v_{j_1,0}v_{i,0}v_{p_1,0}$  by Notation 3.2.2(c), and that  $v_{j_2,k_2}, v_{j_1,0} \not\prec v_{j_2,k_2}v_{j_1,0}v_{i,0}v_{p_1,0}$ , contradicting Lemma 3.1.26.  $\square$

**Proposition 3.2.25.** Let  $(\Sigma_3 G)_\lambda$  be a weighted 3-path suspension of  $G_\omega$  that satisfies the conditions from Notation 3.2.2. Let  $I := I_{3,f}((\Sigma_3 G)_\lambda)$  and  $\underline{n} \in \mathbb{N}^d$ . Let  $\mathfrak{P} := (V'', \delta'')$  with  $V'' \subseteq V((\Sigma_3 G)_\lambda)$  and  $\delta'' : V'' \rightarrow \mathbb{N}$  be such that  $P(V'', \delta'')$  occurs in an m-irreducible decomposition of  $p_{\underline{n}}(I)$  and

$P(V'' \setminus \{v_{i,j}\}, \delta''|_{V'' \setminus \{v_{i,j}\}})$  does not occur in any m-irreducible decomposition of  $p_{\underline{n}}(I)$  for any  $v_{i,j} \in V''$ . Assume that  $v_{i,1}v_{i,0}v_{j_1,0}v_{j_2,k_2} \in \mathfrak{P}_{i,1}$ , then  $(v_{i,0}v_{p_1,0}v_{p_1,1}v_{p_1,2} \rightsquigarrow v_{i,0}v_{p_1,0}v_{p_1,1}) \notin \mathfrak{P}_{i,0}$  for any  $p_1 \neq j_1$  and  $v_{p_1,0} = v_{j_2,k_2}$ .

*Proof.* Proof by contradiction: assume that  $(v_{i,0}v_{p_1,0}v_{p_1,1}v_{p_1,2} \rightsquigarrow v_{i,0}v_{p_1,0}v_{p_1,1}) \in \mathfrak{P}_{i,0}$  for some  $p_1 \neq j_1$  and  $v_{p_1,0} = v_{j_2,k_2}$ .

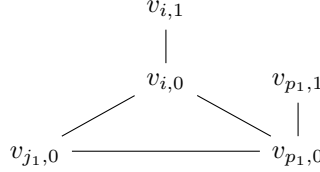

By Notation 3.2.2(b), we have

$$\lambda(v_{p_1,1}v_{p_1,0}) \leq f(\lambda(v_{p_1,2}v_{p_1,1}), \lambda(v_{p_1,1}v_{p_1,0})) < f(\lambda(v_{p_1,2}v_{p_1,1}), \lambda(v_{p_1,1}v_{p_1,0})) + \lambda(v_{p_1,2}v_{p_1,1}).$$

So we have that  $v_{p_1,1} \not\sim v_{i,0}v_{j_1,0}v_{p_1,0}v_{p_1,1}$  and  $v_{p_1,1} \not\sim v_{j_1,0}v_{i,0}v_{p_1,0}v_{p_1,1}$ . Since  $v_{i,0}v_{p_1,0}v_{j_1,0}v_{i,0}$  is a 3-cycle in  $G$  and  $f(\lambda(v_{i,1}v_{i,0}), \lambda(v_{i,0}v_{j_1,0})) < \lambda(v_{i,0}v_{p_1,0})$ , we have the following 2 cases by Notation 3.2.2(e)(2)(iii):

(a)  $f(\lambda(v_{p_1,0}v_{j_1,0}), \lambda(v_{p_1,0}v_{p_1,1})) \leq \max\{\lambda(v_{p_1,0}v_{j_1,0}), f(\lambda(v_{p_1,0}v_{i,0}), \lambda(v_{p_1,0}v_{p_1,1}))\}$ . Then  $v_{p_1,0} \not\sim v_{i,0}v_{j_1,0}v_{p_1,0}v_{p_1,1}$ . Also, we have that  $v_{i,0} \not\sim v_{i,0}v_{j_1,0}v_{p_1,0}v_{p_1,1}$  by Notation 3.2.2(a) and  $v_{j_1,0} \not\sim v_{i,0}v_{j_1,0}v_{p_1,0}v_{p_1,1}$ , contradicting Lemma 3.1.26.

(b)  $f(\lambda(v_{j_1,0}v_{i,0}), \lambda(v_{j_1,0}v_{p_1,0})) \geq \lambda(v_{j_1,0}v_{i,0})$ . Then  $v_{j_1,0} \not\sim v_{j_1,0}v_{i,0}v_{p_1,0}v_{p_1,1}$ . Also, we have that  $v_{i,0} \not\sim v_{j_1,0}v_{i,0}v_{p_1,0}v_{p_1,1}$  by Notation 3.2.2(c) and  $v_{p_1,0} \not\sim v_{j_1,0}v_{i,0}v_{p_1,0}v_{p_1,1}$ , contradicting Lemma 3.1.26.  $\square$

**Proposition 3.2.26.** Let  $(\Sigma_3 G)_\lambda$  be a weighted 3-path suspension of  $G_\omega$  that satisfies the conditions from Notation 3.2.2. Let  $I := I_{3,f}((\Sigma_3 G)_\lambda)$  and  $\underline{n} \in \mathbb{N}^d$ . Let  $\mathfrak{P} := (V'', \delta'')$  with  $V'' \subseteq V((\Sigma_3 G)_\lambda)$  and  $\delta'' : V'' \rightarrow \mathbb{N}$  be such that  $P(V'', \delta'')$  occurs in an m-irreducible decomposition of  $p_{\underline{n}}(I)$  and  $P(V'' \setminus \{v_{i,j}\}, \delta''|_{V'' \setminus \{v_{i,j}\}})$  does not occur in any m-irreducible decomposition of  $p_{\underline{n}}(I)$  for any  $v_{i,j} \in V''$ . Assume that  $v_{i,1}v_{i,0}v_{j_1,0}v_{j_2,k_2} \in \mathfrak{P}_{i,1}$ , then  $(v_{i,0}v_{p_1,0}v_{p_1,1}v_{p_1,2} \rightsquigarrow v_{i,0}v_{p_1,0}) \notin \mathfrak{P}_{i,0}$  for any  $p_1 \neq j_1$  and  $v_{p_1,0} \neq v_{j_2,k_2}$ .

*Proof.* Proof by contradiction: assume that  $(v_{i,0}v_{p_1,0}v_{p_1,1}v_{p_1,2} \rightsquigarrow v_{i,0}v_{p_1,0}) \in \mathfrak{P}_{i,0}$  for some  $p_1 \neq j_1$

and  $v_{p_1,0} \neq v_{j_2,k_2}$ .

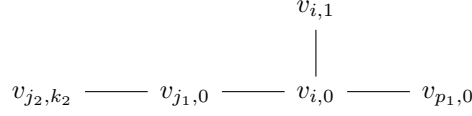

Since

$$\begin{aligned}
 \lambda(v_{i,0}v_{p_1,0}) &\leq f(\lambda(v_{p_1,1}v_{p_1,0}), \lambda(v_{i,0}v_{p_1,0})) \\
 &< f(\lambda(v_{p_1,1}v_{p_1,0}), \lambda(v_{i,0}v_{p_1,0})) + f(\lambda(v_{p_1,2}v_{p_1,1}), \lambda(v_{p_1,1}v_{p_1,0})) + \lambda(v_{p_1,2}v_{p_1,1}),
 \end{aligned}$$

we have that  $v_{p_1,0} \not\sim v_{j_2,k_2}v_{j_1,0}v_{i,0}v_{p_1,0}$ . Also, we have that  $v_{i,0} \not\sim v_{j_2,k_2}v_{j_1,0}v_{i,0}v_{p_1,0}$  by Notation 3.2.2(c), and  $v_{j_2,k_2}, v_{j_1,0} \not\sim v_{j_2,k_2}v_{j_1,0}v_{i,0}v_{p_1,0}$ , contradicting Lemma 3.1.26.  $\square$

**Proposition 3.2.27.** Let  $(\Sigma_3 G)_\lambda$  be a weighted 3-path suspension of  $G_\omega$  that satisfies the conditions from Notation 3.2.2. Let  $I := I_{3,f}((\Sigma_3 G)_\lambda)$  and  $\underline{n} \in \mathbb{N}^d$ . Let  $\mathfrak{P} := (V'', \delta'')$  with  $V'' \subseteq V((\Sigma_3 G)_\lambda)$  and  $\delta'' : V'' \rightarrow \mathbb{N}$  be such that  $P(V'', \delta'')$  occurs in an m-irreducible decomposition of  $p_{\underline{n}}(I)$  and  $P(V'' \setminus \{v_{i,j}\}, \delta''|_{V'' \setminus \{v_{i,j}\}})$  does not occur in any m-irreducible decomposition of  $p_{\underline{n}}(I)$  for any  $v_{i,j} \in V''$ . Assume that  $v_{i,1}v_{i,0}v_{j_1,0}v_{j_2,k_2} \in \mathfrak{P}_{i,1}$ , then  $(v_{i,0}v_{p_1,0}v_{p_1,1}v_{p_1,2} \rightsquigarrow v_{i,0}v_{p_1,0}) \notin \mathfrak{P}_{i,0}$  for any  $p_1 \neq j_1$  and  $v_{p_1,0} = v_{j_2,k_2}$ .

*Proof.* Proof by contradiction: assume that  $(v_{i,0}v_{p_1,0}v_{p_1,1}v_{p_1,2} \rightsquigarrow v_{i,0}v_{p_1,0}) \in \mathfrak{P}_{i,0}$  for some  $p_1 \neq j_1$  and  $v_{p_1,0} = v_{j_2,k_2}$ .

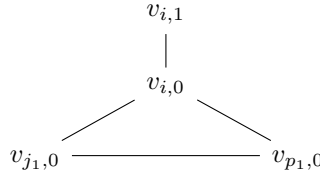

Since  $v_{i,0}v_{p_1,0}v_{j_1,0}v_{i,0}$  is a 3-cycle in  $G$  and  $\lambda(v_{i,0}v_{p_1,0}) > f(\lambda(v_{i,1}v_{i,0}), \lambda(v_{i,0}v_{j_1,0}))$ , we have the following 2 cases by Notation 3.2.2(e)(2)(iii):

(a)  $f(\lambda(v_{p_1,0}v_{j_1,0}), \lambda(v_{p_1,0}v_{p_1,1})) \leq \max\{\lambda(v_{p_1,0}v_{j_1,0}), f(\lambda(v_{p_1,0}v_{i,0}), \lambda(v_{p_1,0}v_{p_1,1}))\}$ .

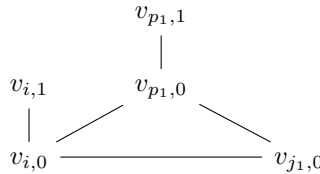

Assume that  $f(\lambda(v_{p_1,0}v_{i,0}), \lambda(v_{p_1,0}v_{p_1,1})) < f(\lambda(v_{p_1,0}v_{j_1,0}), \lambda(v_{p_1,0}v_{p_1,1}))$ . Since  $v_{p_1,0}v_{i,0}v_{j_1,0}v_{p_1,0}$  is a 3-cycle in  $G$ , we have that  $f(\lambda(v_{j_1,0}v_{p_1,0}), \lambda(v_{j_1,0}v_{i,0})) \geq \lambda(v_{j_1,0}v_{i,0})$  by Notation 3.2.2(e)(1). Assume that  $f(\lambda(v_{p_1,0}v_{i,0}), \lambda(v_{p_1,0}v_{p_1,1})) \geq f(\lambda(v_{p_1,0}v_{j_1,0}), \lambda(v_{p_1,0}v_{p_1,1}))$ . Then by Notation 3.2.2(b),

$$\begin{aligned} & f(\lambda(v_{p_1,0}v_{j_1,0}), \lambda(v_{p_1,1}v_{p_1,0})) + \lambda(v_{p_1,1}v_{p_1,0}) \\ & \leq f(\lambda(v_{p_1,0}v_{i,0}), \lambda(v_{p_1,1}v_{p_1,0})) + f(\lambda(v_{p_1,2}v_{p_1,1}), \lambda(v_{p_1,1}v_{p_1,0})) \\ & < f(\lambda(v_{p_1,0}v_{i,0}), \lambda(v_{p_1,1}v_{p_1,0})) + f(\lambda(v_{p_1,2}v_{p_1,1}), \lambda(v_{p_1,1}v_{p_1,0})) + \lambda(v_{p_1,2}v_{p_1,1}). \end{aligned}$$

Thus,  $v_{p_1,0} \not\prec (v_{i,0}v_{j_1,0}v_{p_1,0}v_{p_1,1} \rightsquigarrow v_{i,0}v_{j_1,0}v_{p_1,0})$ . Also,  $v_{i,0} \not\prec (v_{i,0}v_{j_1,0}v_{p_1,0}v_{p_1,1} \rightsquigarrow v_{i,0}v_{j_1,0}v_{p_1,0})$  by Notation 3.2.2(a) and  $v_{j_1,0} \not\prec (v_{i,0}v_{j_1,0}v_{p_1,0}v_{p_1,1} \rightsquigarrow v_{i,0}v_{j_1,0}v_{p_1,0})$ , contradicting Lemma 3.1.26.

(b)  $f(\lambda(v_{j_1,0}v_{i,0}), \lambda(v_{j_1,0}v_{p_1,0})) \geq \lambda(v_{j_1,0}v_{i,0})$ . Then  $v_{j_1,0} \not\prec (v_{j_1,0}v_{i,0}v_{p_1,0}v_{p_1,1} \rightsquigarrow v_{j_1,0}v_{i,0}v_{p_1,0})$ . By Notation 3.2.2(b) we have

$$\begin{aligned} & f(\lambda(v_{p_1,0}v_{i,0}), \lambda(v_{p_1,1}v_{p_1,0})) + \lambda(v_{p_1,1}v_{p_1,0}) \\ & \leq f(\lambda(v_{p_1,0}v_{i,0}), \lambda(v_{p_1,1}v_{p_1,0})) + f(\lambda(v_{p_1,2}v_{p_1,1}), \lambda(v_{p_1,1}v_{p_1,0})) \\ & < f(\lambda(v_{p_1,0}v_{i,0}), \lambda(v_{p_1,1}v_{p_1,0})) + f(\lambda(v_{p_1,2}v_{p_1,1}), \lambda(v_{p_1,1}v_{p_1,0})) + \lambda(v_{p_1,2}v_{p_1,1}). \end{aligned}$$

So we have that  $v_{p_1,0} \not\prec (v_{j_1,0}v_{i,0}v_{p_1,0}v_{p_1,1} \rightsquigarrow v_{j_1,0}v_{i,0}v_{p_1,0})$ . Additionally, we also have that  $v_{i,0} \not\prec (v_{j_1,0}v_{i,0}v_{p_1,0}v_{p_1,1} \rightsquigarrow v_{j_1,0}v_{i,0}v_{p_1,0})$  by Notation 3.2.2(c), contradicting Lemma 3.1.26.  $\square$

**Proposition 3.2.28.** Let  $(\Sigma_3 G)_\lambda$  be a weighted 3-path suspension of  $G_\omega$  that satisfies the conditions from Notation 3.2.2. Let  $I := I_{3,f}((\Sigma_3 G)_\lambda)$  and  $\underline{n} \in \mathbb{N}^d$ . Let  $\mathfrak{P} := (V'', \delta'')$  with  $V'' \subseteq V((\Sigma_3 G)_\lambda)$  and  $\delta'' : V'' \rightarrow \mathbb{N}$  be such that  $P(V'', \delta'')$  occurs in an m-irreducible decomposition of  $p_{\underline{n}}(I)$  and  $P(V'' \setminus \{v_{i,j}\}, \delta''|_{V'' \setminus \{v_{i,j}\}})$  does not occur in any m-irreducible decomposition of  $p_{\underline{n}}(I)$  for any  $v_{i,j} \in V''$ . Assume that  $v_{i,1}v_{i,0}v_{j_1,0}v_{j_2,k_2} \in \mathfrak{P}_{i,1}$ , then  $(v_{i,0}v_{p_1,0}v_{p_2,0}v_{p_2,1} \rightsquigarrow v_{i,0}v_{p_1,0}v_{p_2,0}) \notin \mathfrak{P}_{i,0}$  for any  $v_{j_2,k_2} \neq v_{p_1,0} \neq v_{j_1,0}$  and  $v_{j_2,k_2} \neq v_{p_2,q_2} \neq v_{j_1,0}$ .

*Proof.* Proof by contradiction: assume that  $(v_{i,0}v_{p_1,0}v_{p_2,0}v_{p_2,1} \rightsquigarrow v_{i,0}v_{p_1,0}v_{p_2,0}) \in \mathfrak{P}_{i,0}$  for some  $v_{j_2,k_2} \neq v_{p_1,0} \neq v_{j_1,0}$  and  $v_{j_2,k_2} \neq v_{p_2,q_2} \neq v_{j_1,0}$ .

$$\begin{array}{ccccccc} & & & v_{i,1} & & & \\ & & & | & & & \\ v_{j_2,k_2} & \text{---} & v_{j_1,0} & \text{---} & v_{i,0} & \text{---} & v_{p_1,0} & \text{---} & v_{p_2,0} \end{array}$$

By way of contradiction, we get that  $v_{j_1,0} \smile v_{j_1,0}v_{i,0}v_{p_1,0}v_{p_2,q_2}$ . Since  $v_{j_1,0} \not\smile v_{i,1}v_{i,0}v_{j_1,0}v_{j_2,k_2}$ , we have that  $f(\lambda(v_{j_2,k_2}v_{j_1,0}), \lambda(v_{j_1,0}v_{i,0})) < \lambda(v_{j_1,0}v_{i,0})$ . Then  $k_2 = 0$ , and so  $v_{j_2,k_2}v_{j_1,0}v_{i,0}v_{p_1,0}v_{p_2,0}$  is a 4-path in  $G$ . Since  $f(\lambda(v_{i,1}v_{i,0}), \lambda(v_{i,0}v_{j_1,0})) < \lambda(v_{i,0}v_{p_1,0})$ , we have  $f(\lambda(v_{i,0}v_{p_1,0}), \lambda(v_{p_1,0}v_{p_2,0})) \geq \lambda(v_{i,0}v_{p_1,0})$  by Notation 3.2.2(d). So we have that  $v_{p_1,0} \smile (v_{i,0}v_{p_1,0}v_{p_2,0}v_{p_2,1} \rightsquigarrow v_{i,0}v_{p_1,0}v_{p_2,0})$ , contradicting  $(v_{i,0}v_{p_1,0}v_{p_2,0}v_{p_2,1} \rightsquigarrow v_{i,0}v_{p_1,0}v_{p_2,0}) \in \mathfrak{P}_{i,0}$ .  $\square$

**Proposition 3.2.29.** Let  $(\Sigma_3 G)_\lambda$  be a weighted 3-path suspension of  $G_\omega$  that satisfies the conditions from Notation 3.2.2. Let  $I := I_{3,f}((\Sigma_3 G)_\lambda)$  and  $\underline{n} \in \mathbb{N}^d$ . Let  $\mathfrak{P} := (V'', \delta'')$  with  $V'' \subseteq V((\Sigma_3 G)_\lambda)$  and  $\delta'' : V'' \rightarrow \mathbb{N}$  be such that  $P(V'', \delta'')$  occurs in an m-irreducible decomposition of  $p_{\underline{n}}(I)$  and  $P(V'' \setminus \{v_{i,j}\}, \delta''|_{V'' \setminus \{v_{i,j}\}})$  does not occur in any m-irreducible decomposition of  $p_{\underline{n}}(I)$  for any  $v_{i,j} \in V''$ . Assume that  $v_{i,1}v_{i,0}v_{j_1,0}v_{j_2,k_2} \in \mathfrak{P}_{i,1}$ , then  $(v_{i,0}v_{p_1,0}v_{p_2,0}v_{p_2,1} \rightsquigarrow v_{i,0}v_{p_1,0}v_{p_2,0}) \notin \mathfrak{P}_{i,0}$  for any  $j_1 = p_2$ .

*Proof.* Proof by contradiction: assume  $(v_{i,0}v_{p_1,0}v_{p_2,0}v_{p_2,1} \rightsquigarrow v_{i,0}v_{p_1,0}v_{p_2,0}) \in \mathfrak{P}_{i,0}$  for some  $j_1 = p_2$ .

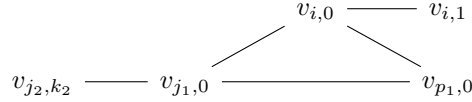

By way of contradiction, we get that  $v_{j_2,k_2}, v_{j_1,0}, v_{i,0} \not\smile v_{j_2,k_2}v_{j_1,0}v_{i,0}v_{p_1,0}$ . Since  $v_{i,0}v_{j_1,0}v_{p_1,0}v_{i,0}$  is a 3-cycle in  $G$  and  $\lambda(v_{i,0}v_{p_1,0}) > f(\lambda(v_{i,1}v_{i,0}), \lambda(v_{i,0}v_{j_1,0}))$ , we have that  $f(\lambda(v_{p_1,0}v_{i,0}), \lambda(v_{p_1,0}v_{j_1,0})) \geq \lambda(v_{p_1,0}v_{i,0})$  by Notation 3.2.2(e)(2)(i). So we have that  $v_{p_1,0} \not\smile v_{j_2,k_2}v_{j_1,0}v_{i,0}v_{p_1,0}$ , contradicting Lemma 3.1.26.  $\square$

**Proposition 3.2.30.** Let  $(\Sigma_3 G)_\lambda$  be a weighted 3-path suspension of  $G_\omega$  that satisfies the conditions from Notation 3.2.2. Let  $I := I_{3,f}((\Sigma_3 G)_\lambda)$  and  $\underline{n} \in \mathbb{N}^d$ . Let  $\mathfrak{P} := (V'', \delta'')$  with  $V'' \subseteq V((\Sigma_3 G)_\lambda)$  and  $\delta'' : V'' \rightarrow \mathbb{N}$  be such that  $P(V'', \delta'')$  occurs in an m-irreducible decomposition of  $p_{\underline{n}}(I)$  and  $P(V'' \setminus \{v_{i,j}\}, \delta''|_{V'' \setminus \{v_{i,j}\}})$  does not occur in any m-irreducible decomposition of  $p_{\underline{n}}(I)$  for any  $v_{i,j} \in V''$ . Assume that  $v_{i,1}v_{i,0}v_{j_1,0}v_{j_2,k_2} \in \mathfrak{P}_{i,1}$ , then  $(v_{i,0}v_{p_1,0}v_{p_2,0}v_{p_2,1} \rightsquigarrow v_{i,0}v_{p_1,0}v_{p_2,0}) \notin \mathfrak{P}_{i,0}$  for any  $v_{j_2,k_2} = v_{p_1,0}$ .

*Proof.* Proof by contradiction: assume that  $(v_{i,0}v_{p_1,0}v_{p_2,0}v_{p_2,1} \rightsquigarrow v_{i,0}v_{p_1,0}v_{p_2,0}) \in \mathfrak{P}_{i,0}$  for some  $v_{j_2,k_2} = v_{p_1,0}$ .

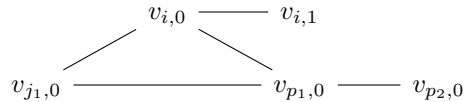



It is straightforward to show  $v_{i,0}, v_{j_1,0}, v_{p_2,0} \not\sim v_{i,0}v_{j_1,0}v_{p_1,0}v_{p_2,0}$  and  $v_{i,0}, v_{p_2,0} \not\sim v_{j_1,0}v_{i,0}v_{p_1,0}v_{p_2,0}$ . Then  $v_{p_1,0} \smile v_{i,0}v_{j_1,0}v_{p_1,0}v_{p_2,0}$ . Since  $v_{i,0}v_{j_1,0}v_{p_1,0}v_{i,0}$  is a 3-cycle and  $f(\lambda(v_{i,1}v_{i,0}), \lambda(v_{i,0}v_{j_1,0})) < \lambda(v_{i,0}v_{p_1,0})$ , we have the following 2 cases by Notation 3.2.2(e)(2)(iii):

(a)  $f(\lambda(v_{p_1,0}v_{j_1,0}), \lambda(v_{p_1,0}v_{p_2,0})) \leq \max\{\lambda(v_{p_1,0}v_{j_1,0}), f(\lambda(v_{p_1,0}v_{i,0}), \lambda(v_{p_1,0}v_{p_2,0}))\}$ . So we have that  $v_{p_1,0} \smile v_{i,1}v_{i,0}v_{j_1,0}v_{p_1,0}$  or that  $v_{p_1,0} \smile (v_{i,0}v_{p_1,0}v_{p_2,0}v_{p_2,1} \rightsquigarrow v_{i,0}v_{p_1,0}v_{p_2,0})$  since  $v_{p_1,0} \smile v_{i,0}v_{j_1,0}v_{p_1,0}v_{p_2,0}$ , a contradiction.

(b)  $f(\lambda(v_{j_1,0}v_{i,0}), \lambda(v_{j_1,0}v_{p_1,0})) \geq \lambda(v_{j_1,0}v_{i,0})$ . Then we have that  $v_{j_1,0} \not\sim v_{j_1,0}v_{i,0}v_{p_1,0}v_{p_2,0}$ . So we have that  $v_{p_1,0} \smile v_{j_1,0}v_{i,0}v_{p_1,0}v_{p_2,0}$ . So we have that  $v_{p_1,0} \smile (v_{i,0}v_{p_1,0}v_{p_2,0}v_{p_2,1} \rightsquigarrow v_{i,0}v_{p_1,0}v_{p_2,0})$ , a contradiction.  $\square$

**Proposition 3.2.31.** Let  $(\Sigma_3 G)_\lambda$  be a weighted 3-path suspension of  $G_\omega$  that satisfies the conditions from Notation 3.2.2. Let  $I := I_{3,f}((\Sigma_3 G)_\lambda)$  and  $\underline{n} \in \mathbb{N}^d$ . Let  $\mathfrak{P} := (V'', \delta'')$  with  $V'' \subseteq V((\Sigma_3 G)_\lambda)$  and  $\delta'' : V'' \rightarrow \mathbb{N}$  be such that  $P(V'', \delta'')$  occurs in an m-irreducible decomposition of  $p_{\underline{n}}(I)$  and  $P(V'' \setminus \{v_{i,j}\}, \delta''|_{V'' \setminus \{v_{i,j}\}})$  does not occur in any m-irreducible decomposition of  $p_{\underline{n}}(I)$  for any  $v_{i,j} \in V''$ . Assume that  $v_{i,1}v_{i,0}v_{j_1,0}v_{j_2,k_2} \in \mathfrak{P}_{i,1}$ , then  $(v_{i,0}v_{p_1,0}v_{p_2,0}v_{p_2,1} \rightsquigarrow v_{i,0}v_{p_1,0}v_{p_2,0}) \notin \mathfrak{P}_{i,0}$  for any  $v_{j_2,k_2} = v_{p_2,0}$  and  $j_1 \neq p_1$ .

*Proof.* Proof by contradiction: assume that  $(v_{i,0}v_{p_1,0}v_{p_2,0}v_{p_2,1} \rightsquigarrow v_{i,0}v_{p_1,0}v_{p_2,0}) \in \mathfrak{P}_{i,0}$  for some  $v_{j_2,k_2} = v_{p_2,0}$  and  $j_1 \neq p_1$ .

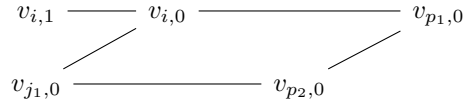

Then

$$\begin{aligned}
 f(\lambda(v_{p_2,0}v_{j_1,0}), \lambda(v_{p_2,0}v_{p_1,0})) &\leq f(\lambda(v_{p_2,0}v_{p_1,0}), \lambda(v_{p_2,0}v_{p_2,1})) \\
 &< f(\lambda(v_{p_2,0}v_{p_1,0}), \lambda(v_{p_2,0}v_{p_2,1})) + \lambda(v_{p_2,0}v_{p_2,1}).
 \end{aligned}$$

So we have that  $v_{p_2,0} \not\sim v_{p_1,0}v_{p_2,0}v_{j_1,0}v_{i,0}$ . By way of contradiction, we get that  $v_{i,0}, v_{j_1,0}, v_{p_2,0} \not\sim v_{p_1,0}v_{p_2,0}v_{j_1,0}v_{i,0}$ . So we have that  $v_{p_1,0} \smile v_{p_1,0}v_{p_2,0}v_{j_1,0}v_{i,0}$ . Since  $v_{i,0}v_{j_1,0}v_{p_2,0}v_{p_1,0}$  is a 4-cycle and  $f(\lambda(v_{i,1}v_{i,0}), \lambda(v_{j_1,0}v_{i,0})) < \lambda(v_{i,0}v_{p_1,0})$ , we have the following 2 cases by Notation 3.2.2(f):

(a)  $f(\lambda(v_{j_1,0}v_{i,0}), \lambda(v_{j_1,0}v_{p_2,0})) \geq \lambda(v_{j_1,0}v_{i,0})$  by Notation 3.2.2(f)(1). So  $v_{j_1,0} \not\sim v_{j_1,0}v_{i,0}v_{p_1,0}v_{p_2,0}$ .

By way of contradiction,  $v_{i,0}, v_{p_1,0}, v_{p_2,0} \not\sim v_{j_1,0}v_{i,0}v_{p_1,0}v_{p_2,0}$ , contradicting Lemma 3.1.26.

(b)  $f(\lambda(v_{p_1,0}v_{i,0}), \lambda(v_{p_1,0}v_{p_2,0})) \geq \min\{\lambda(v_{p_1,0}v_{i,0}), \lambda(v_{p_1,0}v_{p_2,0})\}$  by Notation 3.2.2(f)(2)(i). Then since  $v_{p_1,0} \smile v_{p_1,0}v_{p_2,0}v_{j_1,0}v_{i,0}$ , we have that  $v_{p_1,0} \not\sim v_{p_1,0}v_{i,0}v_{j_1,0}v_{p_2,0}$ . But by way of contradiction, we get that  $v_{i,0}, v_{j_1,0}, v_{p_2,0} \not\sim v_{p_1,0}v_{i,0}v_{j_1,0}v_{p_2,0}$ , contradicting Lemma 3.1.26.  $\square$

**Proposition 3.2.32.** Let  $(\Sigma_3 G)_\lambda$  be a weighted 3-path suspension of  $G_\omega$  that satisfies the conditions from Notation 3.2.2. Let  $I := I_{3,f}((\Sigma_3 G)_\lambda)$  and  $\underline{n} \in \mathbb{N}^d$ . Let  $\mathfrak{P} := (V'', \delta'')$  with  $V'' \subseteq V((\Sigma_3 G)_\lambda)$  and  $\delta'' : V'' \rightarrow \mathbb{N}$  be such that  $P(V'', \delta'')$  occurs in an m-irreducible decomposition of  $p_{\underline{n}}(I)$  and  $P(V'' \setminus \{v_{i,j}\}, \delta''|_{V'' \setminus \{v_{i,j}\}})$  does not occur in any m-irreducible decomposition of  $p_{\underline{n}}(I)$  for any  $v_{i,j} \in V''$ . Assume that  $v_{i,1}v_{i,0}v_{j_1,0}v_{j_2,k_2} \in \mathfrak{P}_{i,1}$ , then  $v_{i,0}v_{p_1,0}v_{p_1,1}v_{p_1,2} \notin \mathfrak{P}_{i,0}$  for any  $v_{j_2,k_2} \neq v_{p_1,0} \neq v_{j_1,0}$ ,  $v_{j_2,k_2} \neq v_{p_2,q_2} \neq v_{j_1,0}$  and  $v_{j_2,k_2} \neq v_{p_3,q_3} \neq v_{j_1,0}$ .

*Proof.* Proof by contradiction: assume that  $v_{i,0}v_{p_1,0}v_{p_1,1}v_{p_1,2} \in \mathfrak{P}_{i,0}$  for some  $v_{j_2,k_2} \neq v_{p_1,0} \neq v_{j_1,0}$ ,  $v_{j_2,k_2} \neq v_{p_2,q_2} \neq v_{j_1,0}$ , and  $v_{j_2,k_2} \neq v_{p_3,q_3} \neq v_{j_1,0}$ .

$$\begin{array}{ccccccccc}
 & & & & v_{i,1} & & & & \\
 & & & & | & & & & \\
 v_{j_2,k_2} & \text{---} & v_{j_1,0} & \text{---} & v_{i,0} & \text{---} & v_{p_1,0} & \text{---} & v_{p_2,q_2} & \text{---} & v_{p_3,q_3}
 \end{array}$$

By way of contradiction, we get that  $v_{p_1,0} \smile v_{j_2,k_2}v_{j_1,0}v_{i,0}v_{p_1,0}$ . Since  $v_{p_1,0} \not\sim v_{i,0}v_{p_1,0}v_{p_2,q_2}v_{p_3,q_3}$ , we have that  $q_2 = 0$ . By way of contradiction, we can only have the two cases  $v_{j_1,0} \smile v_{j_1,0}v_{i,0}v_{p_1,0}v_{p_2,q_2}$  or  $v_{p_2,q_2} \smile v_{j_1,0}v_{i,0}v_{p_1,0}v_{p_2,q_2}$ .

(a) Suppose that  $v_{j_1,0} \smile v_{j_1,0}v_{i,0}v_{p_1,0}v_{p_2,q_2}$ . Since  $v_{j_1,0} \not\sim v_{i,1}v_{i,0}v_{j_1,0}v_{j_2,k_2}$ , we have that  $k_2 = 0$  and  $f(\lambda(v_{j_2,k_2}v_{j_1,0}), \lambda(v_{j_1,0}v_{i,0})) < \lambda(v_{j_1,0}v_{i,0})$ . Then  $v_{j_2,k_2}v_{j_1,0}v_{i,0}v_{p_1,0}v_{p_2,q_2}$  is a 4-path in  $G$ . Since  $f(\lambda(v_{i,1}v_{i,0}), \lambda(v_{i,0}v_{j_1,0})) < \lambda(v_{i,0}v_{p_1,0})$ , we have that  $f(\lambda(v_{i,0}v_{p_1,0}), \lambda(v_{p_1,0}v_{p_2,q_2})) \geq \lambda(v_{i,0}v_{p_1,0})$  by Notation 3.2.2(d), contradicting  $v_{p_1,0} \smile v_{j_2,k_2}v_{j_1,0}v_{i,0}v_{p_1,0}$  and  $v_{p_1,0} \not\sim v_{i,0}v_{p_1,0}v_{p_2,q_2}v_{p_3,q_3}$ .

(b) Suppose that  $v_{p_2,q_2} \smile v_{j_1,0}v_{i,0}v_{p_1,0}v_{p_2,q_2}$ . Since  $v_{p_2,q_2} \not\sim v_{i,0}v_{p_1,0}v_{p_2,q_2}v_{p_3,q_3}$ , we have that  $q_3 = 0$  and  $f(\lambda(v_{p_1,0}v_{p_2,q_2}), \lambda(v_{p_2,q_2}v_{p_3,q_3})) < \lambda(v_{p_1,0}v_{p_2,q_2})$ . Then  $v_{j_1,0}v_{i,0}v_{p_1,0}v_{p_2,q_2}v_{p_3,q_3}$  is a 4-path. Since  $f(\lambda(v_{i,1}v_{i,0}), \lambda(v_{i,0}v_{j_1,0})) < \lambda(v_{i,0}v_{p_1,0})$ , we have that  $f(\lambda(v_{j_1,0}v_{i,0}), \lambda(v_{i,0}v_{p_1,0})) \geq \lambda(v_{i,0}v_{p_1,0})$  by Notation 3.2.2(d), contradicting  $v_{i,0} \smile v_{i,0}v_{p_1,0}v_{p_2,q_2}v_{p_3,q_3}$  and  $v_{i,0} \not\sim v_{j_2,k_2}v_{j_1,0}v_{i,0}v_{p_1,0}$ .  $\square$

**Proposition 3.2.33.** Let  $(\Sigma_3 G)_\lambda$  be a weighted 3-path suspension of  $G_\omega$  that satisfies the conditions from Notation 3.2.2. Let  $I := I_{3,f}((\Sigma_3 G)_\lambda)$  and  $\underline{n} \in \mathbb{N}^d$ . Let  $\mathfrak{P} := (V'', \delta'')$  with  $V'' \subseteq V((\Sigma_3 G)_\lambda)$

and  $\delta'' : V'' \rightarrow \mathbb{N}$  be such that  $P(V'', \delta'')$  occurs in an m-irreducible decomposition of  $p_{\underline{n}}(I)$  and  $P(V'' \setminus \{v_{i,j}\}, \delta''|_{V'' \setminus \{v_{i,j}\}})$  does not occur in any m-irreducible decomposition of  $p_{\underline{n}}(I)$  for any  $v_{i,j} \in V''$ . Assume that  $v_{i,1}v_{i,0}v_{j_1,0}v_{j_2,k_2} \in \mathfrak{P}_{i,1}$ , then  $v_{i,0}v_{p_1,0}v_{p_2,q_2}v_{p_3,q_3} \notin \mathfrak{P}_{i,0}$  for any  $v_{j_1,0} = v_{p_2,q_2}$  and  $v_{p_3,q_3} = v_{j_2,k_2}$ .

*Proof.* Proof by contradiction: assume that  $v_{i,0}v_{p_1,0}v_{p_2,q_2}v_{p_3,q_3} \in \mathfrak{P}_{i,0}$  for some  $v_{j_1,0} = v_{p_2,q_2}$  and  $v_{p_3,q_3} = v_{j_2,k_2}$ .

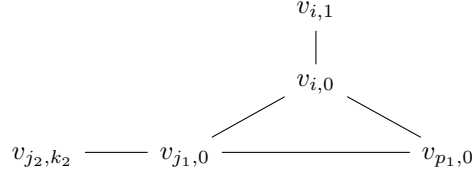

By way of contradiction, we get that  $v_{j_2,k_2}, v_{j_1,0}, v_{i,0} \not\sim v_{j_2,k_2}v_{j_1,0}v_{i,0}v_{p_1,0}$ . Since  $v_{i,0}v_{j_1,0}v_{p_1,0}v_{i,0}$  is a 3-cycle in  $G$  and  $f(\lambda(v_{i,1}v_{i,0}), \lambda(v_{i,0}v_{j_1,0})) < \lambda(v_{i,0}v_{p_1,0})$ , we have that  $f(\lambda(v_{p_1,0}v_{i,0}), \lambda(v_{p_1,0}v_{j_1,0})) \geq \lambda(v_{p_1,0}v_{i,0})$  by Notation 3.2.2(e)(2)(i). So we have that  $v_{p_1,0} \not\sim v_{j_2,k_2}v_{j_1,0}v_{i,0}v_{p_1,0}$ , contradicting Lemma 3.1.26.  $\square$

**Proposition 3.2.34.** Let  $(\Sigma_3 G)_\lambda$  be a weighted 3-path suspension of  $G_\omega$  that satisfies the conditions from Notation 3.2.2. Let  $I := I_{3,f}((\Sigma_3 G)_\lambda)$  and  $\underline{n} \in \mathbb{N}^d$ . Let  $\mathfrak{P} := (V'', \delta'')$  with  $V'' \subseteq V((\Sigma_3 G)_\lambda)$  and  $\delta'' : V'' \rightarrow \mathbb{N}$  be such that  $P(V'', \delta'')$  occurs in an m-irreducible decomposition of  $p_{\underline{n}}(I)$  and  $P(V'' \setminus \{v_{i,j}\}, \delta''|_{V'' \setminus \{v_{i,j}\}})$  does not occur in any m-irreducible decomposition of  $p_{\underline{n}}(I)$  for any  $v_{i,j} \in V''$ . Assume that  $v_{i,1}v_{i,0}v_{j_1,0}v_{j_2,k_2} \in \mathfrak{P}_{i,1}$ , then  $v_{i,0}v_{p_1,0}v_{p_2,q_2}v_{p_3,q_3} \notin \mathfrak{P}_{i,0}$  for any  $v_{j_1,0} = v_{p_2,q_2}$  and  $v_{p_3,q_3} \neq v_{j_2,k_2}$ .

*Proof.* Proof by contradiction: assume that  $v_{i,0}v_{p_1,0}v_{p_2,q_2}v_{p_3,q_3} \in \mathfrak{P}_{i,0}$  for some  $v_{j_1,0} = v_{p_2,q_2}$  and  $v_{p_3,q_3} \neq v_{j_2,k_2}$ .

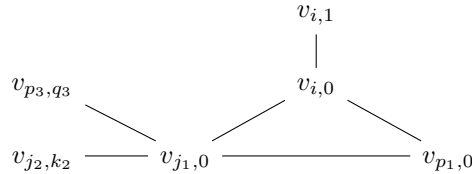

Then the proof is similar to the proof of Proposition 3.2.33.  $\square$

**Proposition 3.2.35.** Let  $(\Sigma_3 G)_\lambda$  be a weighted 3-path suspension of  $G_\omega$  that satisfies the conditions from Notation 3.2.2. Let  $I := I_{3,f}((\Sigma_3 G)_\lambda)$  and  $\underline{n} \in \mathbb{N}^d$ . Let  $\mathfrak{P} := (V'', \delta'')$  with  $V'' \subseteq V((\Sigma_3 G)_\lambda)$  and  $\delta'' : V'' \rightarrow \mathbb{N}$  be such that  $P(V'', \delta'')$  occurs in an m-irreducible decomposition of  $p_{\underline{n}}(I)$  and

$P(V'' \setminus \{v_{i,j}\}, \delta''|_{V'' \setminus \{v_{i,j}\}})$  does not occur in any m-irreducible decomposition of  $p_{\underline{n}}(I)$  for any  $v_{i,j} \in V''$ . Assume that  $v_{i,1}v_{i,0}v_{j_1,0}v_{j_2,k_2} \in \mathfrak{P}_{i,1}$ , then  $v_{i,0}v_{p_1,0}v_{p_2,q_2}v_{p_3,q_3} \notin \mathfrak{P}_{i,0}$  for any  $v_{j_1,0} = v_{p_2,q_2}$  and  $v_{j_2,k_2} = v_{p_1,0}$ .

*Proof.* Proof by contradiction: assume that  $v_{i,0}v_{p_1,0}v_{p_2,q_2}v_{p_3,q_3} \in \mathfrak{P}_{i,0}$  for some  $v_{j_1,0} = v_{p_2,q_2}$  and  $v_{j_2,k_2} = v_{p_1,0}$ .

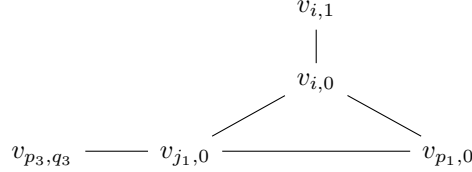

Since  $v_{i,0}v_{j_1,0}v_{p_1,0}v_{i,0}$  is a 3-cycle in  $G$  and  $f(\lambda(v_{i,1}v_{i,0}), \lambda(v_{i,0}v_{j_1,0})) < \lambda(v_{i,0}v_{p_1,0})$ , we have that  $f(\lambda(v_{p_1,0}v_{i,0}), \lambda(v_{p_1,0}v_{j_1,0})) \geq \lambda(v_{p_1,0}v_{i,0})$  and

$$f(\lambda(v_{j_1,0}v_{i,0}), \lambda(v_{j_1,0}v_{p_3,q_3})) \leq \max\{f(\lambda(v_{j_1,0}v_{i,0}), \lambda(v_{j_1,0}v_{p_1,0})), f(\lambda(v_{j_1,0}v_{p_3,q_3}), \lambda(v_{j_1,0}v_{p_1,0}))\},$$

by Notation 3.2.2(e)(2)(ii). So we have that  $v_{p_1,0}, v_{j_1,0} \not\sim v_{p_3,q_3}v_{j_1,0}v_{i,0}v_{p_1,0}$ . Also, we have that  $v_{p_3,q_3}, v_{i,0} \not\sim v_{p_3,q_3}v_{j_1,0}v_{i,0}v_{p_1,0}$ , contradicting Lemma 3.1.26.  $\square$

**Proposition 3.2.36.** Let  $(\Sigma_3 G)_\lambda$  be a weighted 3-path suspension of  $G_\omega$  that satisfies the conditions from Notation 3.2.2. Let  $I := I_{3,f}((\Sigma_3 G)_\lambda)$  and  $\underline{n} \in \mathbb{N}^d$ . Let  $\mathfrak{P} := (V'', \delta'')$  with  $V'' \subseteq V((\Sigma_3 G)_\lambda)$  and  $\delta'' : V'' \rightarrow \mathbb{N}$  be such that  $P(V'', \delta'')$  occurs in an m-irreducible decomposition of  $p_{\underline{n}}(I)$  and  $P(V'' \setminus \{v_{i,j}\}, \delta''|_{V'' \setminus \{v_{i,j}\}})$  does not occur in any m-irreducible decomposition of  $p_{\underline{n}}(I)$  for any  $v_{i,j} \in V''$ . Assume that  $v_{i,1}v_{i,0}v_{j_1,0}v_{j_2,k_2} \in \mathfrak{P}_{i,1}$ , then  $v_{i,0}v_{p_1,0}v_{p_2,q_2}v_{p_3,q_3} \notin \mathfrak{P}_{i,0}$  for any  $v_{j_2,k_2} = v_{p_1,0}$  and  $v_{p_3,q_3} \neq v_{j_1,0}$ .

*Proof.* Proof by contradiction: assume that  $v_{i,0}v_{p_1,0}v_{p_2,q_2}v_{p_3,q_3} \in \mathfrak{P}_{i,0}$  for some  $v_{j_2,k_2} = v_{p_1,0}$  and  $v_{p_3,q_3} \neq v_{j_1,0}$ .

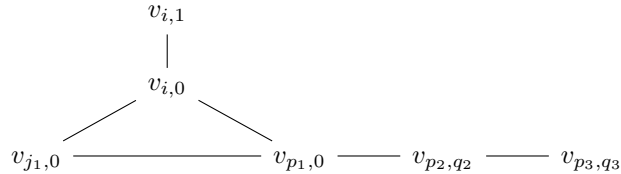

Then by way of contradiction, we get that  $f(\lambda(v_{i,1}v_{i,0}), \lambda(v_{i,0}v_{j_1,0})) < \lambda(v_{i,0}v_{p_1,0})$  and  $v_{i,0}, v_{j_1,0} \not\sim v_{i,0}v_{j_1,0}v_{p_1,0}v_{p_2,q_2}$ . Suppose that  $v_{p_2,q_2} \sim v_{i,0}v_{j_1,0}v_{p_1,0}v_{p_2,q_2}$ . Then as  $v_{p_2,q_2} \not\sim v_{i,0}v_{p_1,0}v_{p_2,q_2}v_{p_3,q_3}$ , we have that  $q_2 = 0$  by Notation 3.2.2(b). Then  $q_3 = 0$  by Notation 3.2.2(a). So we have that

$v_{j_1,0}v_{i,0}v_{p_1,0}v_{p_2,0}v_{p_3,0}$  is a 4-path in  $G$ . Since  $\lambda(v_{p_1,0}v_{p_2,0}) > f(\lambda(v_{p_1,0}v_{p_2,0}), \lambda(v_{p_2,0}v_{p_3,0}))$ , by Notation 3.2.2(d) we have

$$\lambda(v_{i,0}v_{p_1,0}) \leq f(\lambda(v_{j_1,0}v_{i,0}), \lambda(v_{i,0}v_{p_1,0})) \leq f(\lambda(v_{i,1}v_{i,0}), \lambda(v_{i,0}v_{j_1,0})),$$

a contradiction. Hence  $v_{p_2,0} \not\sim v_{i,0}v_{j_1,0}v_{p_1,0}v_{p_2,0}$  and so  $v_{p_1,0} \smile v_{i,0}v_{j_1,0}v_{p_1,0}v_{p_2,0}$ . By Notation 3.2.2(e)(2)(iii), we have the following 2 cases:

(a)  $f(\lambda(v_{p_1,0}v_{j_1,0}), \lambda(v_{p_1,0}v_{p_2,0})) \leq \max\{\lambda(v_{p_1,0}v_{j_1,0}), f(\lambda(v_{p_1,0}v_{i,0}), \lambda(v_{p_1,0}v_{p_2,0}))\}$ . Then since  $v_{p_1,0} \smile v_{i,0}v_{j_1,0}v_{p_1,0}v_{p_2,0}$ , we have that  $v_{p_1,0} \smile v_{i,0}v_{p_1,0}v_{p_2,0}v_{p_3,0}$ , a contradiction.

(b)  $f(\lambda(v_{j_1,0}v_{i,0}), \lambda(v_{j_1,0}v_{p_1,0})) \geq \lambda(v_{j_1,0}v_{i,0})$ . Then we have that  $v_{j_1,0} \not\sim v_{j_1,0}v_{i,0}v_{p_1,0}v_{p_2,0}$ . Also, since  $v_{i,0}, v_{p_2,0} \not\sim v_{j_1,0}v_{i,0}v_{p_1,0}v_{p_2,0}$ , we have that  $v_{p_1,0} \smile v_{j_1,0}v_{i,0}v_{p_1,0}v_{p_2,0}$ . So we have that  $v_{p_1,0} \smile v_{i,0}v_{p_1,0}v_{p_2,0}v_{p_3,0}$ , a contradiction.  $\square$

**Proposition 3.2.37.** Let  $(\Sigma_3 G)_\lambda$  be a weighted 3-path suspension of  $G_\omega$  that satisfies the conditions from Notation 3.2.2. Let  $I := I_{3,f}((\Sigma_3 G)_\lambda)$  and  $\underline{n} \in \mathbb{N}^d$ . Let  $\mathfrak{P} := (V'', \delta'')$  with  $V'' \subseteq V((\Sigma_3 G)_\lambda)$  and  $\delta'' : V'' \rightarrow \mathbb{N}$  be such that  $P(V'', \delta'')$  occurs in an m-irreducible decomposition of  $p_{\underline{n}}(I)$  and  $P(V'' \setminus \{v_{i,j}\}, \delta''|_{V'' \setminus \{v_{i,j}\}})$  does not occur in any m-irreducible decomposition of  $p_{\underline{n}}(I)$  for any  $v_{i,j} \in V''$ . Assume that  $v_{i,1}v_{i,0}v_{j_1,0}v_{j_2,0} \in \mathfrak{P}_{i,1}$ , then  $v_{i,0}v_{p_1,0}v_{p_2,0}v_{p_3,0} \notin \mathfrak{P}_{i,0}$  for any  $v_{j_2,0} = v_{p_1,0}$  and  $v_{p_3,0} = v_{j_1,0}$ .

*Proof.* Proof by contradiction: assume that  $v_{i,0}v_{p_1,0}v_{p_2,0}v_{p_3,0} \in \mathfrak{P}_{i,0}$  for some  $v_{j_2,0} = v_{p_1,0}$  and  $v_{p_3,0} = v_{j_1,0}$ .

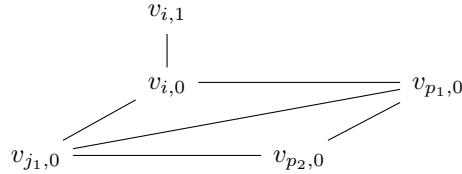

So we have that  $q_2 = 0$ . Since  $v_{i,1}v_{i,0}v_{j_1,0}v_{p_1,0} \in \mathfrak{P}_{i,1}$ , we have that  $f(\lambda(v_{i,1}v_{i,0}), \lambda(v_{i,0}v_{j_1,0})) < \lambda(v_{i,0}v_{p_1,0})$  and that  $v_{i,0}, v_{j_1,0} \not\sim v_{i,0}v_{j_1,0}v_{p_1,0}v_{p_2,0}$ . Since  $v_{i,0}v_{j_1,0}v_{p_1,0}v_{i,0}$  is a 3-cycle in  $G$ , we have that  $f(\lambda(v_{p_1,0}v_{j_1,0}), \lambda(v_{p_1,0}v_{p_2,0})) \leq \max\{\lambda(v_{p_1,0}v_{j_1,0}), f(\lambda(v_{p_1,0}v_{i,0}), \lambda(v_{p_1,0}v_{p_2,0}))\}$  or that  $f(\lambda(v_{j_1,0}v_{i,0}), \lambda(v_{j_1,0}v_{p_1,0})) \geq \lambda(v_{j_1,0}v_{i,0})$  by Notation 3.2.2(e)(2)(iii). So we have that  $v_{p_1,0} \not\sim v_{i,0}v_{j_1,0}v_{p_1,0}v_{p_2,0}$  or  $v_{j_1,0} \not\sim v_{j_1,0}v_{i,0}v_{p_1,0}v_{p_2,0}$ . Hence by way of contradiction, we get that  $v_{p_2,0} \smile v_{i,0}v_{j_1,0}v_{p_1,0}v_{p_2,0}$  or  $v_{p_2,0} \smile v_{j_1,0}v_{i,0}v_{p_1,0}v_{p_2,0}$ . So we have that  $\delta''(v_{p_2,0}) \leq \lambda(v_{p_2,0}v_{p_1,0})$ . Since

$v_{i,0}v_{j_1,0}v_{p_2,0}v_{p_1,0}v_{i,0}$  is a 4-cycle in  $G$  and  $v_{j,0}v_{l,0} \in E(G)$ , we have the following 3 cases by Notation 3.2.2(f):

(a)  $f(\lambda(v_{p_2,0}v_{j_1,0}), \lambda(v_{p_2,0}v_{p_1,0})) \geq \lambda(v_{p_2,0}v_{p_1,0})$  by Notation 3.2.2(f)(1) or (f)(2)(iii). As  $\delta''(v_{p_2,0}) \leq \lambda(v_{p_2,0}v_{p_1,0})$ , we have that  $v_{p_2,0} \smile v_{i,0}v_{p_1,0}v_{p_2,0}v_{j_1,0}$ , a contradiction.

(b)  $f(\lambda(v_{p_1,0}v_{i,0}), \lambda(v_{p_1,0}v_{p_2,0})) \geq \lambda(v_{p_1,0}v_{p_2,0})$  and

$$f(\lambda(v_{j_1,0}v_{i,0}), \lambda(v_{j_1,0}v_{p_2,0})) \leq \max\{\lambda(v_{j_1,0}v_{p_2,0}), f(\lambda(v_{j_1,0}v_{i,0}), \lambda(v_{j_1,0}v_{p_1,0}))\},$$

by Notation 3.2.2(f)(2)(iii). Then  $v_{p_1,0}, v_{j_1,0} \not\prec v_{i,0}v_{j_1,0}v_{p_2,0}v_{p_1,0}$ . But we have that  $v_{i,0}, v_{p_2,0} \not\prec v_{i,0}v_{j_1,0}v_{p_2,0}v_{p_1,0}$ , contradicting Lemma 3.1.26.

(c)  $f(\lambda(v_{p_2,0}v_{j_1,0}), \lambda(v_{p_2,0}v_{p_1,0})) \geq \lambda(v_{p_2,0}v_{j_1,0})$ ,  $f(\lambda(v_{p_1,0}v_{i,0}), \lambda(v_{p_1,0}v_{p_2,0})) \geq \lambda(v_{p_1,0}v_{i,0})$ , and

$$f(\lambda(v_{j_1,0}v_{i,0}), \lambda(v_{j_1,0}v_{p_2,0})) \leq \max\{\lambda(v_{j_1,0}v_{p_2,0}), f(\lambda(v_{j_1,0}v_{i,0}), \lambda(v_{j_1,0}v_{p_1,0}))\},$$

by Notation 3.2.2(f)(2)(iii). Then  $v_{p_2,0}, v_{p_1,0}, v_{j_1,0}, v_{i,0} \not\prec v_{p_2,0}v_{j_1,0}v_{i,0}v_{p_1,0}$ . But we have that  $v_{i,0} \not\prec v_{p_2,0}v_{j_1,0}v_{i,0}v_{p_1,0}$ , contradicting Lemma 3.1.26.  $\square$

**Proposition 3.2.38.** Let  $(\Sigma_3 G)_\lambda$  be a weighted 3-path suspension of  $G_\omega$  that satisfies the conditions from Notation 3.2.2. Let  $I := I_{3,f}((\Sigma_3 G)_\lambda)$  and  $\underline{n} \in \mathbb{N}^d$ . Let  $\mathfrak{P} := (V'', \delta'')$  with  $V'' \subseteq V((\Sigma_3 G)_\lambda)$  and  $\delta'' : V'' \rightarrow \mathbb{N}$  be such that  $P(V'', \delta'')$  occurs in an m-irreducible decomposition of  $p_{\underline{n}}(I)$  and  $P(V'' \setminus \{v_{i,j}\}, \delta''|_{V'' \setminus \{v_{i,j}\}})$  does not occur in any m-irreducible decomposition of  $p_{\underline{n}}(I)$  for any  $v_{i,j} \in V''$ . Assume that  $v_{i,1}v_{i,0}v_{j_1,0}v_{j_2,k_2} \in \mathfrak{P}_{i,1}$ , then  $v_{i,0}v_{p_1,0}v_{p_2,q_2}v_{p_3,q_3} \notin \mathfrak{P}_{i,0}$  for any  $v_{j_2,k_2} = v_{p_2,q_2}$  and  $v_{p_3,q_3} = v_{j_1,0}$ .

*Proof.* Proof by contradiction: assume that  $v_{i,0}v_{p_1,0}v_{p_2,q_2}v_{p_3,q_3} \in \mathfrak{P}_{i,0}$  for some  $v_{j_2,k_2} = v_{p_2,q_2}$  and  $v_{p_3,q_3} = v_{j_1,0}$ .

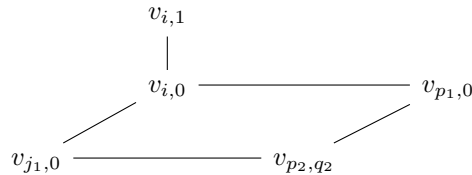

Then by way of contradiction, we get that  $v_{p_1,0} \smile v_{p_1,0}v_{i,0}v_{j_1,0}v_{p_2,q_2}$  and  $v_{p_1,0} \smile v_{p_1,0}v_{p_2,q_2}v_{j_1,0}v_{i,0}$ . Since  $v_{i,0}v_{j_1,0}v_{p_2,q_2}v_{p_1,0}$  is a 4-cycle in  $G$  and  $f(\lambda(v_{i,1}v_{i,0}), \lambda(v_{i,0}v_{j_1,0})) < \lambda(v_{i,0}v_{p_1,0})$ , we have the following 2 cases by Notation 3.2.2(f):

(a)  $f(\lambda(v_{p_2,q_2}v_{j_1,0}), \lambda(v_{p_2,q_2}v_{p_1,0})) \geq \lambda(v_{p_2,q_2}v_{p_1,0})$  and  $f(\lambda(v_{j_1,0}v_{i,0}), \lambda(v_{j_1,0}v_{p_2,q_2})) \geq \lambda(v_{j_1,0}v_{i,0})$  by Notation 3.2.2(f)(1). Then  $v_{p_2,q_2}, v_{j_1,0} \not\prec v_{j_1,0}v_{i,0}v_{p_1,0}v_{p_2,q_2}$ . But  $v_{i,0}, v_{p_1,0} \not\prec v_{j_1,0}v_{i,0}v_{p_1,0}v_{p_2,q_2}$ , contradicting Lemma 3.1.26.

(b)  $f(\lambda(v_{p_1,0}v_{i,0}), \lambda(v_{p_1,0}v_{p_2,0})) \geq \min\{\lambda(v_{p_1,0}v_{i,0}), \lambda(v_{p_1,0}v_{p_2,0})\}$  by Notation 3.2.2(f)(2)(i). Then  $v_{p_1,0} \smile v_{i,0}v_{p_1,0}v_{p_2,q_2}v_{p_3,q_3}$ , a contradiction.  $\square$

**Proposition 3.2.39.** Let  $(\Sigma_3 G)_\lambda$  be a weighted 3-path suspension of  $G_\omega$  that satisfies the conditions from Notation 3.2.2. Let  $I := I_{3,f}((\Sigma_3 G)_\lambda)$  and  $\underline{n} \in \mathbb{N}^d$ . Let  $\mathfrak{P} := (V'', \delta'')$  with  $V'' \subseteq V((\Sigma_3 G)_\lambda)$  and  $\delta'' : V'' \rightarrow \mathbb{N}$  be such that  $P(V'', \delta'')$  occurs in an m-irreducible decomposition of  $p_{\underline{n}}(I)$  and  $P(V'' \setminus \{v_{i,j}\}, \delta''|_{V'' \setminus \{v_{i,j}\}})$  does not occur in any m-irreducible decomposition of  $p_{\underline{n}}(I)$  for any  $v_{i,j} \in V''$ . Assume that  $v_{i,1}v_{i,0}v_{j_1,0}v_{j_2,k_2} \in \mathfrak{P}_{i,1}$ , then  $v_{i,0}v_{p_1,0}v_{p_2,q_2}v_{p_3,q_3} \notin \mathfrak{P}_{i,0}$  for any  $v_{j_2,k_2} = v_{p_2,q_2}$  and  $v_{p_3,q_3} \neq v_{j_1,0} \neq v_{p_1,0}$ .

*Proof.* Proof by contradiction: assume that  $v_{i,0}v_{p_1,0}v_{p_2,q_2}v_{p_3,q_3} \in \mathfrak{P}_{i,0}$  for some  $v_{j_2,k_2} = v_{p_2,q_2}$  and  $v_{p_3,q_3} \neq v_{j_1,0} \neq v_{p_1,0}$ .

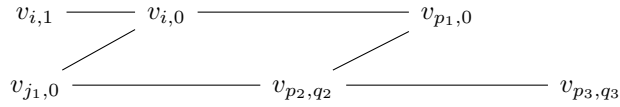

Then  $q_2 = 0$ . Since  $v_{i,0}v_{j_1,0}v_{p_2,q_2}v_{p_1,0}$  is a 4-cycle in  $G$  and  $f(\lambda(v_{i,1}v_{i,0}), \lambda(v_{i,0}v_{j_1,0})) < \lambda(v_{i,0}v_{p_1,0})$ , we have the following 5 cases by Notation 3.2.2(f):

(a)  $f(\lambda(v_{j_1,0}v_{i,0}), \lambda(v_{j_1,0}v_{p_2,q_2})) \geq \lambda(v_{j_1,0}v_{i,0})$  by Notation 3.2.2(f)(1) or (f)(2)(iv). Then we have that  $v_{j_1,0} \not\prec v_{j_1,0}v_{i,0}v_{p_1,0}v_{p_2,q_2}$ . Since  $v_{i,0}, v_{p_1,0} \not\prec v_{j_1,0}v_{i,0}v_{p_1,0}v_{p_2,q_2}$ , we have that  $v_{p_2,q_2} \smile v_{j_1,0}v_{i,0}v_{p_1,0}v_{p_2,q_2}$ . Since  $v_{p_2,q_2} \not\prec v_{i,0}v_{p_1,0}v_{p_2,q_2}v_{p_3,q_3}$ , we have that  $q_3 = 0$  and  $\lambda(v_{p_2,q_2}v_{p_1,0}) > f(\lambda(v_{p_2,q_2}v_{p_1,0}), \lambda(v_{p_2,q_2}v_{p_3,q_3}))$ . So we have that  $v_{j_1,0}v_{i,0}v_{p_1,0}v_{p_2,q_2}v_{p_3,q_3}$  is a 4-path in  $G$ . Hence by Notation 3.2.2(d), we have the following which provides a contradiction

$$\lambda(v_{i,0}v_{p_1,0}) \leq f(\lambda(v_{i,0}v_{j_1,0}), \lambda(v_{i,0}v_{p_1,0})) \leq f(\lambda(v_{i,1}v_{i,0}), \lambda(v_{i,0}v_{j_1,0})).$$

(b)  $f(\lambda(v_{p_1,0}v_{i,0}), \lambda(v_{p_1,0}v_{p_2,q_2})) \geq \lambda(v_{p_1,0}v_{i,0})$  by Notation 3.2.2(f)(2)(iv). Then we have that  $v_{p_1,0} \not\prec v_{p_1,0}v_{i,0}v_{j_1,0}v_{p_2,q_2}$ . But  $v_{i,0}, v_{j_1,0}, v_{p_2,q_2} \not\prec v_{p_1,0}v_{i,0}v_{j_1,0}v_{p_2,q_2}$ , contradicting Lemma 3.1.26.

(c)  $f(\lambda(v_{p_1,0}v_{i,0}), \lambda(v_{p_1,0}v_{p_2,q_2})) \geq \min\{\lambda(v_{p_1,0}v_{i,0}), \lambda(v_{p_1,0}v_{p_2,q_2})\}$  and

$$f(\lambda(v_{p_2,q_2}v_{j_1,0}), \lambda(v_{p_2,q_2}v_{p_1,0})) \leq \lambda(v_{p_2,q_2}v_{p_1,0}),$$

by Notation 3.2.2(f)(2)(iv). By way of contradiction, we get that  $v_{p_1,0} \smile v_{p_1,0}v_{i,0}v_{j_1,0}v_{p_2,q_2}$ . So we have that  $v_{p_1,0} \not\prec v_{p_1,0}v_{p_2,q_2}v_{j_1,0}$ . Since  $v_{i,0}, v_{j_1,0} \not\prec v_{p_1,0}v_{p_2,q_2}v_{j_1,0}$ , we have that  $v_{p_2,q_2} \smile v_{p_1,0}v_{p_2,q_2}v_{j_1,0}$ . Then  $v_{p_2,q_2} \smile v_{p_2,q_2}v_{p_1,0}v_{i,0}v_{j_1,0}$ . Since  $v_{p_2,q_2} \not\prec v_{i,0}v_{p_1,0}v_{p_2,q_2}v_{p_3,q_3}$ , we have that  $q_3 = 0$ . So we have that  $v_{j_1,0}v_{i,0}v_{p_1,0}v_{p_2,q_2}v_{p_3,q_3}$  is a 4-path in  $G$ . Since  $f(\lambda(v_{j_1,0}v_{i,0}), \lambda(v_{i,0}v_{p_1,0})) < \lambda(v_{i,0}v_{p_1,0})$ , we have that  $\lambda(v_{p_1,0}v_{p_2,q_2}) \leq f(\lambda(v_{p_1,0}v_{p_2,q_2}), \lambda(v_{p_2,q_2}v_{p_3,q_3}))$ , contradicting  $v_{p_2,q_2} \smile v_{p_2,q_2}v_{p_1,0}v_{i,0}v_{j_1,0}$  and  $v_{p_2,q_2} \not\prec v_{i,0}v_{p_1,0}v_{p_2,q_2}v_{p_3,q_3}$ .

(d)  $f(\lambda(v_{p_1,0}v_{i,0}), \lambda(v_{p_1,0}v_{p_2,q_2})) \geq \min(\lambda(v_{p_1,0}v_{i,0}), \lambda(v_{p_1,0}v_{p_2,q_2}))$  and

$$f(\lambda(v_{p_2,q_2}v_{j_1,0}), \lambda(v_{p_2,q_2}v_{p_1,0})) \leq \max\{\lambda(v_{p_2,q_2}v_{j_1,0}), f(\lambda(v_{p_2,q_2}v_{p_1,0}), \lambda(v_{p_2,q_2}v_{p_3,q_3}))\},$$

by Notations 3.2.2(f)(2)(i) and (f)(2)(iv). Then  $v_{p_2,q_2} \not\prec v_{p_1,0}v_{p_2,q_2}v_{j_1,0}v_{i,0}$ . Since  $v_{j_1,0}, v_{i,0} \not\prec v_{p_1,0}v_{p_2,q_2}v_{j_1,0}v_{i,0}$ , we have that  $v_{p_1,0} \smile v_{p_1,0}v_{p_2,q_2}v_{j_1,0}v_{i,0}$ . So we have  $v_{p_1,0} \not\prec v_{p_1,0}v_{i,0}v_{j_1,0}v_{p_2,q_2}$ . But  $v_{i,0}, v_{j_1,0}, v_{p_2,q_2} \not\prec v_{p_1,0}v_{i,0}v_{j_1,0}v_{p_2,q_2}$ , contradicting Lemma 3.1.26.

(e)  $f(\lambda(v_{p_2,q_2}v_{j_1,0}), \lambda(v_{p_2,q_2}v_{p_3,q_3})) \leq \max\{\lambda(v_{p_2,q_2}v_{j_1,0}), f(\lambda(v_{p_2,q_2}v_{p_1,0}), \lambda(v_{p_2,q_2}v_{p_3,q_3}))\}$  by Notation 3.2.2(f)(2)(iv). Then  $v_{p_2,q_2} \not\prec v_{i,0}v_{j_1,0}v_{p_2,q_2}v_{p_3,q_3}$ . But we have that  $v_{i,0}, v_{j_1,0}, v_{p_3,q_3} \not\prec v_{i,0}v_{j_1,0}v_{p_2,q_2}v_{p_3,q_3}$ , contradicting Lemma 3.1.26.  $\square$

**Proposition 3.2.40.** Let  $(\Sigma_3 G)_\lambda$  be a weighted 3-path suspension of  $G_\omega$  that satisfies the conditions from Notation 3.2.2. Let  $I := I_{3,f}((\Sigma_3 G)_\lambda)$  and  $\underline{n} \in \mathbb{N}^d$ . Let  $\mathfrak{P} := (V'', \delta'')$  with  $V'' \subseteq V((\Sigma_3 G)_\lambda)$  and  $\delta'' : V'' \rightarrow \mathbb{N}$  be such that  $P(V'', \delta'')$  occurs in an m-irreducible decomposition of  $p_{\underline{n}}(I)$  and  $P(V'' \setminus \{v_{i,j}\}, \delta''|_{V'' \setminus \{v_{i,j}\}})$  does not occur in any m-irreducible decomposition of  $p_{\underline{n}}(I)$  for any  $v_{i,j} \in V''$ . Assume that  $v_{i,1}v_{i,0}v_{j_1,0}v_{j_2,k_2} \in \mathfrak{P}_{i,1}$ , then  $v_{i,0}v_{p_1,0}v_{p_2,q_2}v_{p_3,q_3} \notin \mathfrak{P}_{i,0}$  for any  $v_{j_1,0} = v_{p_3,q_3}$  and  $v_{p_1,0} \neq v_{j_2,k_2} \neq v_{p_2,0}$ .

*Proof.* Proof by contradiction: assume that  $v_{i,0}v_{p_1,0}v_{p_2,q_2}v_{p_3,q_3} \in \mathfrak{P}_{i,0}$  for some  $v_{j_1,0} = v_{p_3,q_3}$  and  $v_{p_1,0} \neq v_{j_2,k_2} \neq v_{p_2,0}$ .

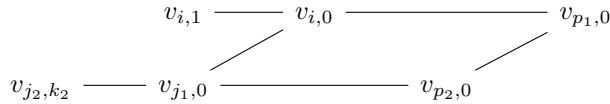



Then by way of contradiction, we get that  $v_{p_1,0} \smile v_{p_1,0}v_{i,0}v_{j_1,0}v_{j_2,k_2}$ . Since  $v_{i,0}v_{j_1,0}v_{p_2,q_2}v_{p_1,0}$  is a 4-cycle in  $G_\omega$  and  $f(\lambda(v_{i,1}v_{i,0}), \lambda(v_{i,0}v_{j_1,0})) < \lambda(v_{i,0}v_{p_1,0})$ , we have the following 4 cases by Notation 3.2.2(f):

(a)  $f(\lambda(v_{p_2,0}v_{j_1,0}), \lambda(v_{p_2,0}v_{p_1,0})) \geq \lambda(v_{p_2,0}v_{p_1,0})$  by Notation 3.2.2(f)(1) or (f)(2)(v). Then  $v_{p_2,0} \not\smile v_{j_1,0}v_{i,0}v_{p_1,0}v_{p_2,0}$ . Note that  $v_{i,0}, v_{p_1,0} \not\smile v_{j_1,0}v_{i,0}v_{p_1,0}v_{p_2,0}$ , so  $v_{j_1,0} \smile v_{j_1,0}v_{i,0}v_{p_1,0}v_{p_2,0}$ . Since  $v_{j_1,0} \not\smile v_{i,1}v_{i,0}v_{j_1,0}v_{j_2,k_2}$ , we have that  $k = 0$  and  $f(\lambda(v_{j_2,k_2}v_{j_1,0}), \lambda(v_{j_1,0}v_{i,0})) < \lambda(v_{j_1,0}v_{i,0})$ . So we have that  $v_{j_2,k_2}v_{j_1,0}v_{i,0}v_{p_1,0}v_{p_2,0}$  is a 4-path in  $G$ . Hence  $\lambda(v_{i,0}v_{p_1,0}) \geq f(\lambda(v_{i,0}v_{p_1,0}), \lambda(v_{p_1,0}v_{p_2,0}))$ , contradicting  $v_{p_1,0} \smile v_{p_1,0}v_{i,0}v_{j_1,0}v_{j_2,k_2}$  and  $v_{p_1,0} \not\smile v_{i,0}v_{p_1,0}v_{p_2,0}v_{j_1,0}$ .

(b)  $f(\lambda(v_{p_1,0}v_{i,0}), \lambda(v_{p_1,0}v_{p_2,0}))$  by Notation 3.2.2(f)(2)(v). Then  $v_{p_1,0} \not\smile v_{p_1,0}v_{i,0}v_{j_1,0}v_{j_2,k_2}$ . But  $v_{i,0}, v_{j_1,0}, v_{j_2,k_2} \not\smile v_{p_1,0}v_{i,0}v_{j_1,0}v_{j_2,k_2}$ , contradicting Lemma 3.1.26.

(c)  $f(\lambda(v_{p_1,0}v_{i,0}), \lambda(v_{p_1,0}v_{p_2,0})) \geq \min\{\lambda(v_{p_1,0}v_{i,0}), \lambda(v_{p_1,0}v_{p_2,0})\}$  and

$$f(\lambda(v_{j_1,0}v_{i,0}), \lambda(v_{j_1,0}v_{p_2,0})) \leq \max\{\lambda(v_{j_1,0}v_{p_2,0}), f(\lambda(v_{j_1,0}v_{i,0}), \lambda(v_{j_1,0}v_{j_2,k_2}))\},$$

by Notations 3.2.2(f)(2)(i) and (f)(2)(v). So we have that  $v_{j_1,0} \not\smile v_{p_1,0}v_{p_2,0}v_{j_1,0}v_{i,0}$ . By way of contradiction we have that  $v_{p_1,0} \smile v_{p_1,0}v_{i,0}v_{j_1,0}v_{j_2,k_2}$ . Since  $v_{p_1,0} \not\smile v_{i,0}v_{p_1,0}v_{p_2,0}v_{j_1,0}$  we have that  $v_{p_1,0} \not\smile v_{p_1,0}v_{p_2,0}v_{j_1,0}v_{i,0}$ . But  $v_{i,0}, v_{p_2,0} \not\smile v_{p_1,0}v_{p_2,0}v_{j_1,0}v_{i,0}$ , contradicting Lemma 3.1.26.

(d)  $f(\lambda(v_{p_1,0}v_{i,0}), \lambda(v_{p_1,0}v_{p_2,0})) \geq \min\{\lambda(v_{p_1,0}v_{i,0}), \lambda(v_{p_1,0}v_{p_2,0})\}$  and

$$f(\lambda(v_{j_1,0}v_{p_2,0}), \lambda(v_{j_1,0}v_{j_2,k_2})) \leq \max\{\lambda(v_{j_1,0}v_{p_2,0}), f(\lambda(v_{j_1,0}v_{i,0}), \lambda(v_{j_1,0}v_{j_2,k_2}))\},$$

by Notations 3.2.2(f)(2)(i) and (f)(2)(v). Then  $v_{j_1,0} \not\smile v_{p_1,0}v_{p_2,0}v_{j_1,0}v_{j_2,k_2}$ . Similar to Case (c), we have that  $v_{p_1,0} \not\smile v_{p_1,0}v_{p_2,0}v_{j_1,0}v_{j_2,k_2}$ . But  $v_{j_2,k_2}, v_{p_2,0} \not\smile v_{p_1,0}v_{p_2,0}v_{j_1,0}v_{j_2,k_2}$ , contradicting Lemma 3.1.26.  $\square$

**Proposition 3.2.41.** Let  $(\Sigma_3 G)_\lambda$  be a weighted 3-path suspension of  $G_\omega$  that satisfies the conditions from Notation 3.2.2. Let  $I := I_{3,f}((\Sigma_3 G)_\lambda)$  and  $\underline{n} \in \mathbb{N}^d$ . Let  $\mathfrak{P} := (V'', \delta'')$  with  $V'' \subseteq V((\Sigma_3 G)_\lambda)$  and  $\delta'' : V'' \rightarrow \mathbb{N}$  be such that  $P(V'', \delta'')$  occurs in an m-irreducible decomposition of  $p_{\underline{n}}(I)$  and  $P(V'' \setminus \{v_{i,j}\}, \delta''|_{V'' \setminus \{v_{i,j}\}})$  does not occur in any m-irreducible decomposition of  $p_{\underline{n}}(I)$  for any  $v_{i,j} \in V''$ . Assume that  $v_{i,1}v_{i,0}v_{j_1,0}v_{j_2,k_2} \in \mathfrak{P}_{i,1}$ , then  $v_{i,0}v_{p_1,0}v_{p_2,q_2}v_{p_3,q_3} \notin \mathfrak{P}_{i,0}$  for any  $v_{j_2,k_2} = v_{p_3,q_3}$  and  $v_{p_1,0} \neq v_{j_1,0} \neq v_{p_2,q_2}$ .

*Proof.* Proof by contradiction: assume that  $v_{i,0}v_{p_1,0}v_{p_2,q_2}v_{p_3,q_3} \in \mathfrak{P}_{i,0}$  for some  $v_{j_2,k_2} = v_{p_3,q_3}$  and  $v_{p_1,0} \neq v_{j_1,0} \neq v_{p_2,q_2}$ .

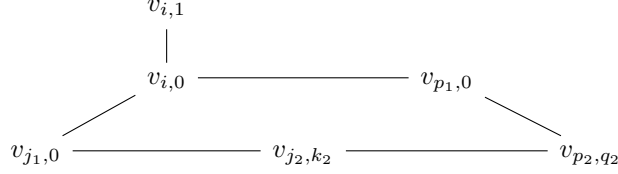

Then  $k_2 = 0 = q_2$  and the proof is similar to the proof of Proposition 3.2.32.  $\square$

**Proposition 3.2.42.** Let  $(\Sigma_3 G)_\lambda$  be a weighted 3-path suspension of  $G_\omega$  that satisfies the conditions from Notation 3.2.2. Let  $I := I_{3,f}((\Sigma_3 G)_\lambda)$  and  $\underline{n} \in \mathbb{N}^d$ . Let  $\mathfrak{P} := (V'', \delta'')$  with  $V'' \subseteq V((\Sigma_3 G)_\lambda)$  and  $\delta'' : V'' \rightarrow \mathbb{N}$  be such that  $P(V'', \delta'')$  occurs in an m-irreducible decomposition of  $p_{\underline{n}}(I)$  and  $P(V'' \setminus \{v_{i,j}\}, \delta''|_{V'' \setminus \{v_{i,j}\}})$  does not occur in any m-irreducible decomposition of  $p_{\underline{n}}(I)$  for any  $v_{i,j} \in V''$ . Then for  $i = 1, \dots, d$ , we have  $v_{i,0} \notin V''$  or  $v_{i,1} \notin V''$ .

*Proof.* Proof by contradiction: assume that  $v_{i,0} \in V''$  and  $v_{i,1} \in V''$ . Then similar to the proof of Proposition 3.2.16, we have that

$$v_{i,3}v_{i,2}v_{i,1}v_{i,0}, (v_{i,3}v_{i,2}v_{i,1}v_{i,0} \rightsquigarrow v_{i,2}v_{i,1}v_{i,0}), (v_{i,3}v_{i,2}v_{i,1}v_{i,0} \rightsquigarrow v_{i,1}v_{i,0}) \notin \mathfrak{P}_{i,1}.$$

Proposition 3.2.17 and Lemma 3.1.30 imply that  $v_{i,2}v_{i,1}v_{i,0}v_{j_1,0} \notin \mathfrak{P}_{i,1}$  for any  $v_{i,0}v_{j_1,0} \in E(G)$ . Proposition 3.2.18 and Lemma 3.1.30 imply that  $(v_{i,1}v_{i,0}v_{j_1,0}v_{j_1,0} \rightsquigarrow v_{i,1}v_{i,0}v_{j_1,0}) \notin \mathfrak{P}_{i,1}$  for any  $v_{i,0}v_{j_1,0} \in E(G)$ . Proposition 3.2.19 to 3.2.41 and Lemma 3.1.30 say that  $v_{i,1}v_{i,0}v_{j_1,0}v_{j_2,k_2} \notin \mathfrak{P}_{i,1}$  for any 3-path  $v_{i,1}v_{i,0}v_{j_1,0}v_{j_2,k_2}$  in  $\Sigma_3 G$ . Thus, we get that  $\mathfrak{P}_{i,1} = \emptyset$ , contradicting Lemma 3.1.30.  $\square$

**Proposition 3.2.43.** Let  $(\Sigma_3 G)_\lambda$  be a weighted 3-path suspension of  $G_\omega$  that satisfies the conditions from Notation 3.2.2. Let  $I := I_{3,f}((\Sigma_3 G)_\lambda)$  and  $\underline{n} \in \mathbb{N}^d$ . Let  $\mathfrak{P} := (V'', \delta'')$  with  $V'' \subseteq V((\Sigma_3 G)_\lambda)$  and  $\delta'' : V'' \rightarrow \mathbb{N}$  be such that  $P(V'', \delta'')$  occurs in an m-irreducible decomposition of  $p_{\underline{n}}(I)$  and  $P(V'' \setminus \{v_{i,j}\}, \delta''|_{V'' \setminus \{v_{i,j}\}})$  does not occur in any m-irreducible decomposition of  $p_{\underline{n}}(I)$  for any  $v_{i,j} \in V''$ . Then there exists at most one  $v_{i,i_j} \in V''$  for  $i = 1, \dots, d$ . Note also that there exists a  $v_{i,i_j} \in V''$  for  $i = 1, \dots, d$ , so  $p_{\underline{n}}(I)$  is unmixed.

*Proof.* It follows from Proposition 3.2.3, 3.2.4, 3.2.16, and 3.2.42  $\square$

We discuss the sufficient conditions for  $I_{r,f}((\Sigma_r G)_\lambda)$  to be unmixed for the remaining cases  $r \geq 4$ .

**Proposition 3.2.44.** Assume that  $r \geq 4$ . Let  $(\Sigma_r G)_\lambda$  be a weighted  $r$ -path suspension of  $G_\omega$  such that  $\lambda(v_i v_j) \leq f(\lambda(v_i v_j), \lambda(v_i v_{i,1})) \leq \lambda(v_i v_{i,1})$  and  $\lambda(v_i v_j) \leq f(\lambda(v_i v_j), \lambda(v_j v_{j,1})) \leq \lambda(v_j v_{j,1})$  for all edges  $v_i v_j \in E((\Sigma_r G)_\lambda)$  and  $\lambda(v_{i,k} v_{i,k+1}) \leq f(\lambda(v_{i,k} v_{i,k+1}), \lambda(v_{i,k+1} v_{i,k+2}))$  for  $i = 1, \dots, d$  and  $k = 0, \dots, r-2$ ,  $f(\lambda(v_i v_j), \lambda(v_j v_k)) \leq \lambda(v_j v_{j,1})$  and for all 2-paths  $v_i v_j v_k$  in  $G$ :

$$f(\lambda(v_i v_j), \lambda(v_j v_k)) \leq f(\lambda(v_i v_j), \lambda(v_j v_{j,1})) = f(\lambda(v_k v_j), \lambda(v_j v_{j,1})).$$

Let  $I := I_{r,f}((\Sigma_r G)_\lambda)$  and  $\underline{n} \in \mathbb{N}^d$ . Let  $\mathfrak{P} := (V'', \delta'')$  with  $V'' \subseteq V((\Sigma_r G)_\lambda)$  and  $\delta'' : V'' \rightarrow \mathbb{N}$  be such that  $P(V'', \delta'')$  occurs in an irredundant  $m$ -irreducible decomposition of  $p_{\underline{n}}(I)$ . Then there exists a unique  $v_{i,i_j} \in V''$  for  $i = 1, \dots, d$ . Note also that there exists a  $v_{i,i_j} \in V''$  for  $i = 1, \dots, d$ , so  $p_{\underline{n}}(I)$  is unmixed.

*Proof.* Suppose there exist  $v_{i,\alpha}, v_{i,\beta} \in V''$  with  $0 \leq \alpha < \beta \leq r$ . Suppose that  $v_{i,\beta} \smile (P_r \rightsquigarrow \wp)$  for some  $r$ -path  $P_r$  and some path  $\wp \in p_{\underline{n}}(I)$ , then we must have that  $v_{i,\alpha} \in V(\wp)$ . But since  $\mathfrak{P}_{i,\alpha} \neq \emptyset$  by Lemma 3.1.30, it is straightforward to show that  $v_{i,\alpha} \smile (P_r \rightsquigarrow \wp)$ . So we have that  $\mathfrak{P}_{i,\beta} = \emptyset$ , contradicting Lemma 3.1.30. Note that for  $i = 1, \dots, d$ , by the definition of  $p_{\underline{n}}(I)$ , we have that there exists a generator where all variables are of the form  $X_{i,i_l}$  with  $i_l \in \{0, \dots, r\}$ , so there exists a vertex  $v_{i,i_j} \in V''$ .  $\square$

**Example 3.2.45.** Let  $r = 4$  and  $f = \min$ . Let  $(\Sigma_4 G)_\lambda$  be a weighted 4-path suspension of  $G_\omega := v_1 \overset{6}{-} v_2 \overset{6}{-} v_3 \overset{3}{-} v_4$  :

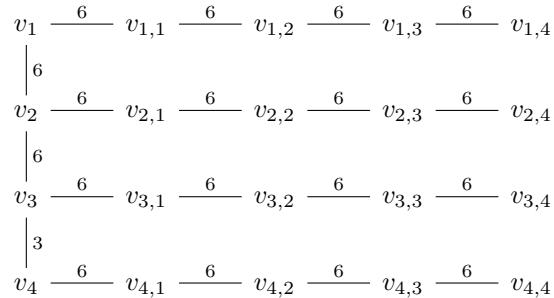

Then  $\mathfrak{P}_1 := \{v_1^6, v_2^6, v_3^6, v_4^3\}$  is a minimal min-weighted 4-path vertex cover of  $(\Sigma_4 G)_\lambda$ . It is depicted in the following drawing, where  $v_i^{i_j} \in \mathfrak{P}_1$  if and only if it is encompassed by a circle. Note that

$|\mathfrak{P}_1| = 4$ .

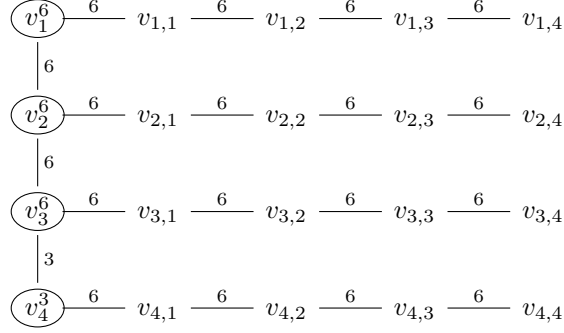

In fact, it is straightforward to show that the cardinality of any minimal min-weighted 4-path vertex cover of  $(\Sigma_4 G)_\lambda$  is at least 4. Also, we can see that there always exists a minimal min-weighted 4-path vertex cover of cardinality 4, generated from the min-weighted 4-path vertex cover  $\{v_1^1, v_2^1, v_3^1, v_4^1\}$ . We see that  $\mathfrak{P}_2 := \{v_1^6, v_{2,2}^6, v_3^6, v_{3,3}^6, v_{4,1}^6\}$  is another minimal min-weighted 4-path vertex cover of  $(\Sigma_4 G)_\lambda$  depicted in the following sketch.

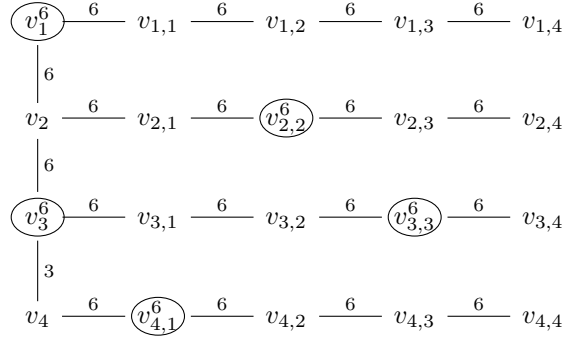

Since  $|\mathfrak{P}_2| = 5$ , we have that  $I_{r,\min}((\Sigma_4 G)_\lambda)$  is mixed by the definition of mixedness and Fact 3.1.7.

**Example 3.2.46.** Let  $r = 4$  and  $f = \min$ . Let  $(\Sigma_4 G)_\lambda$  be a weighted 4-path suspension of

$$G_\omega := v_1 \xrightarrow{6} v_2 \xrightarrow{6} v_3 \xrightarrow{9} v_4 :$$

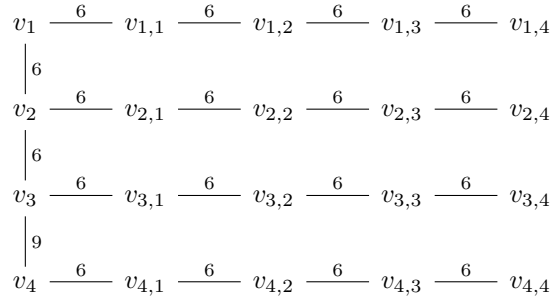

The only difference between the above graph  $(\Sigma_4 G)_\lambda$  and the one from Example 3.2.45 is the weight of  $v_3 v_4$ . Then  $\mathfrak{P}_1 := \{v_1^6, v_2^6, v_3^6, v_4^6\}$  is a minimal min-weighted 4-path vertex cover of  $(\Sigma_4 G)_\lambda$  depicted in the following.

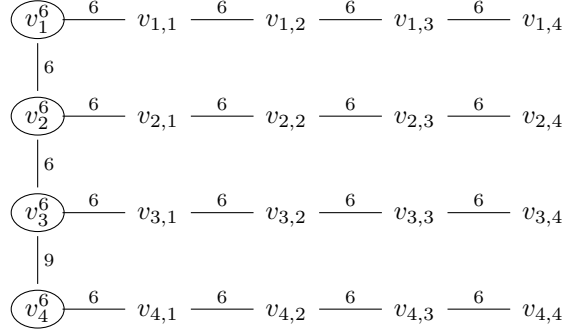

In fact, it is straightforward to show that the cardinality of any minimal min-weighted 4-path vertex cover of  $(\Sigma_4 G)_\lambda$  is at least 4. Also, we can see that there always exists a minimal min-weighted 4-path vertex cover of cardinality 4, generated from the min-weighted 4-path vertex cover  $\{v_1^1, v_2^1, v_3^1, v_4^1\}$ . We see that  $\mathfrak{P}_2 := \{v_1^6, v_2^6, v_3^9, v_{3,1}^6, v_{4,4}^6\}$  is another minimal min-weighted 4-path vertex cover of  $(\Sigma_4 G)_\lambda$  depicted in the following.

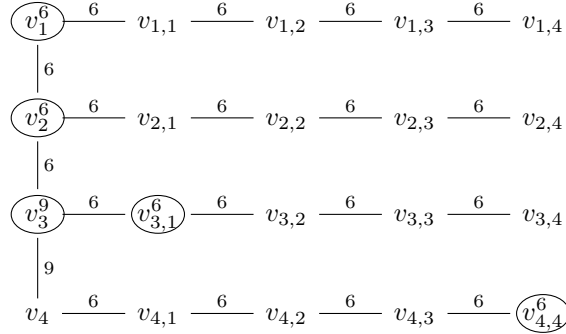

Since  $|\mathfrak{P}_2| = 5$ , we have that  $I_{r,\min}((\Sigma_4 G)_\lambda)$  is mixed by the definition of mixedness and Fact 3.1.7.

From Examples 3.2.45 and 3.2.46, we see that there must be some strict constraints on the weights of  $G$  to make  $I_{r,\min}((\Sigma_4 G)_\lambda)$  be unmixed. We will show that in general when  $r \geq 4$ , if  $I_{r,\min}(\Sigma_4 G_\omega)$  is unmixed, then all edges in  $G$  have the same weight, i.e.,  $\omega = \lambda|_G$  is a constant. This result can be found in Corollary 3.5.3, Proposition 3.2.44, and Theorem 3.3.4.

### 3.3 Necessary Conditions for Unmixedness

In this section, we prove the necessary conditions for which the  $f$ -weighted  $r$ -path ideal of a weighted  $r$ -path suspension is unmixed. We divide the classification into 3 kinds of cases. We first discuss the necessary conditions for  $I_{r,f}((\Sigma_r G)_\lambda)$  to be unmixed for the case  $r = 2$ .

**Lemma 3.3.1.** Let  $(\Sigma_r G)_\lambda$  be a weighted  $r$ -path suspension of  $G_\omega$ . If  $I_{r,f}((\Sigma_r G)_\lambda)$  is unmixed, then  $\lambda(v_i v_j) \leq f(\lambda(v_i v_j), \lambda(v_i v_{i,1})) \leq \lambda(v_i v_{i,1})$  and  $\lambda(v_i v_j) \leq f(\lambda(v_i v_j), \lambda(v_j v_{j,1})) \leq \lambda(v_j v_{j,1})$  for all edges  $v_i v_j \in E(G)$  and  $\lambda(v_{i,k} v_{i,k+1}) \leq f(\lambda(v_{i,k} v_{i,k+1}), \lambda(v_{i,k+1} v_{i,k+2}))$  for  $i = 1, \dots, d$  and  $k = 0, \dots, r-2$ ,  $f(\lambda(v_{i_1} v_{i_2}), \lambda(v_{i_2} v_{i_3})) \leq \lambda(v_{i_2} v_{i_2,1})$ ,  $f(\lambda(v_{i_1} v_{i_2}), \lambda(v_{i_2} v_{i_3})) \leq f(\lambda(v_{i_1} v_{i_2}), \lambda(v_{i_2} v_{i_2,1}))$  and  $f(\lambda(v_{i_1} v_{i_2}), \lambda(v_{i_2} v_{i_3})) \leq f(\lambda(v_{i_3} v_{i_2}), \lambda(v_{i_2} v_{i_2,1}))$  for all 2-paths  $v_{i_1} v_{i_2} v_{i_3}$  in  $G$ .

*Proof.* Since  $\{v_1^1, \dots, v_d^1\}$  is an  $f$ -weighted  $r$ -path vertex cover of  $(\Sigma_r G)_\lambda$ , by Fact 3.1.6, there exists a minimal  $f$ -weighted  $r$ -path vertex cover  $(V''', \delta''')$  of  $(\Sigma_r G)_\lambda$  such that  $(V''', \delta''') \leq \{v_1^1, \dots, v_d^1\}$ . By the minimality of  $V'''$ , we have that  $V''' = \{v_1, \dots, v_d\}$  and so  $|V'''| = d$ . Hence by [7, Theorem 2.7], it suffices to show that if Conditions on weights are not satisfied, then there exists an  $f$ -weighted  $r$ -path vertex cover  $\mathfrak{P} := (V'', \delta'')$  of  $(\Sigma_r G)_\lambda$  such that  $|V''| = d + 1$  and  $\mathfrak{P}_{i,j} \neq \emptyset$  for each  $v_{i,j} \in V''$ .

(a) Suppose that  $a := \lambda(v_{i,s-1} v_{i,s}) > f(\lambda(v_{i,s-1} v_{i,s}), \lambda(v_{i,s} v_{i,s+1}))$  for some  $i \in \{1, \dots, d\}$  and some  $s \in \{1, \dots, r-1\}$ . We use the following diagram as a guide for constructing  $\mathfrak{P}$ , where the column represents  $G$  and rows represent the  $r$ -whiskers in  $\Sigma_r G$ . A vertex encompassed by a circle is in  $V''$ .

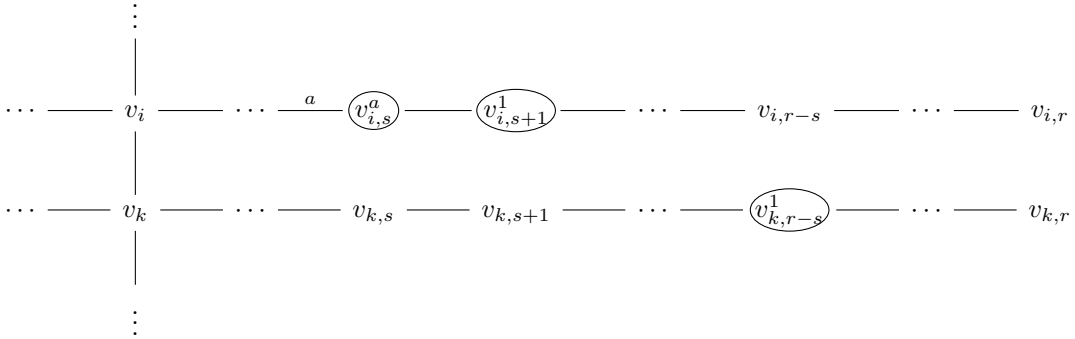

Then it is straightforward to show that

$$\mathfrak{P} := (V'', \delta'') := \{v_{i,s+1}^1, v_{i,s}^a, v_{k,r-s}^1\} \sqcup \{v_m^1 \mid m \in \{1, \dots, d\} \setminus \{i, k\}\}$$

is an  $f$ -weighted  $r$ -path vertex cover of  $(\Sigma_r G)_\lambda$  such that  $|V''| = d + 1$ ,  $v_{i,r} \cdots v_{i,1} v_i \in \mathfrak{P}_{i,s+1}$ ,

$v_{i,s} \cdots v_{i,1} v_i v_k v_{k,1} \cdots v_{k,r-s-1} \in \mathfrak{P}_{i,s}$ ,  $v_{k,r} \cdots v_{k,1} v_k \in \mathfrak{P}_{k,r-s}$ , and  $v_{t,r} \cdots v_{t,1} v_t \in \mathfrak{P}_{t,0}$  for any  $t$  in  $\{1, \dots, d\} \setminus \{i, k\}$ .

(b) Suppose that  $a := \lambda(v_i v_k) > f(\lambda(v_{i,1} v_i), \lambda(v_i v_k))$  for some  $i \in \{1, \dots, d\}$  and some  $v_i v_k \in E(G)$ . The following diagram has the same representation as in (a) except for the elements in  $V''$ .

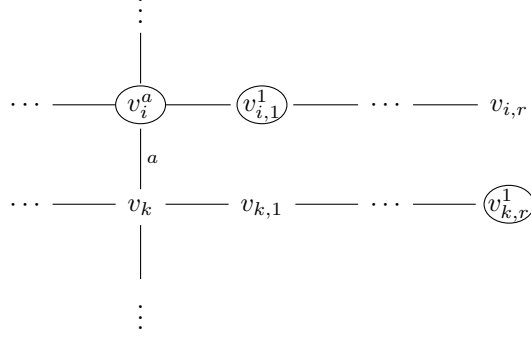

Then it is straightforward to show that

$$\mathfrak{P} := (V'', \delta'') := \{v_{i,1}^1, v_i^a, v_{k,r}^1\} \sqcup \{v_m^1 \mid m \in \{1, \dots, d\} \setminus \{i, k\}\}$$

is an  $f$ -weighted  $r$ -path vertex cover of  $(\Sigma_r G)_\lambda$  such that  $|V''| = d + 1$ ,  $v_{i,1} v_i v_k v_{k,1} \cdots v_{k,r-2} \in \mathfrak{P}_{i,1}$ ,  $v_i v_k v_{k,1} \cdots v_{k,r-1} \in \mathfrak{P}_{i,0}$ ,  $v_{k,r} \cdots v_{k,1} v_k \in \mathfrak{P}_{k,r}$ , and  $v_{t,r} \cdots v_{t,1} v_t \in \mathfrak{P}_{t,0}$  for any  $t \in \{1, \dots, d\} \setminus \{i, k\}$ .

(c) Suppose  $a := f(\lambda(v_{i,1} v_i), \lambda(v_i v_k)) > \lambda(v_i v_{i,1})$  for some  $i \in \{1, \dots, d\}$  and some  $v_i v_k \in E(G)$ .

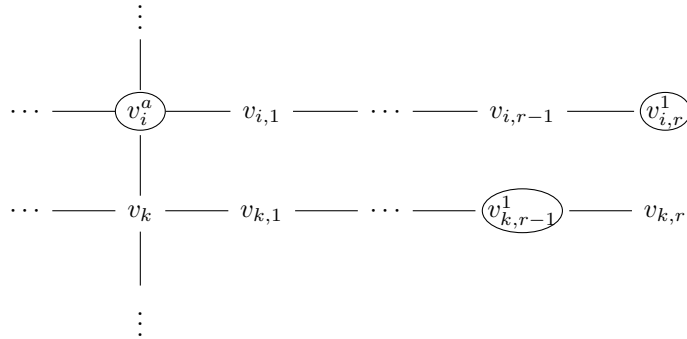

It is straightforward to show that  $\mathfrak{P} := (V'', \delta'') := \{v_{i,r}^1, v_i^a, v_{k,r-1}^1\} \sqcup \{v_m^1 \mid m \in \{1, \dots, d\} \setminus \{i, k\}\}$  is an  $f$ -weighted  $r$ -path vertex cover of  $(\Sigma_r G)_\lambda$  such that  $|V''| = d + 1$ ,  $v_{i,1} v_i v_k v_{k,1} \cdots v_{k,r-2} \in \mathfrak{P}_{i,0}$ ,  $v_i \cdots v_{i,r} \in \mathfrak{P}_{i,r}$ ,  $v_{k,r} \cdots v_{k,1} v_k \in \mathfrak{P}_{k,r-1}$ , and  $v_{t,r} \cdots v_{t,1} v_t \in \mathfrak{P}_{t,0}$  for any  $t \in \{1, \dots, d\} \setminus \{i, k\}$ .

(d) Suppose that  $a := f(\lambda(v_j v_i), \lambda(v_j v_k)) > f(\lambda(v_i v_j), \lambda(v_j v_{j,1}))$  for some 2-path  $v_i v_j v_k$  in  $G$ .

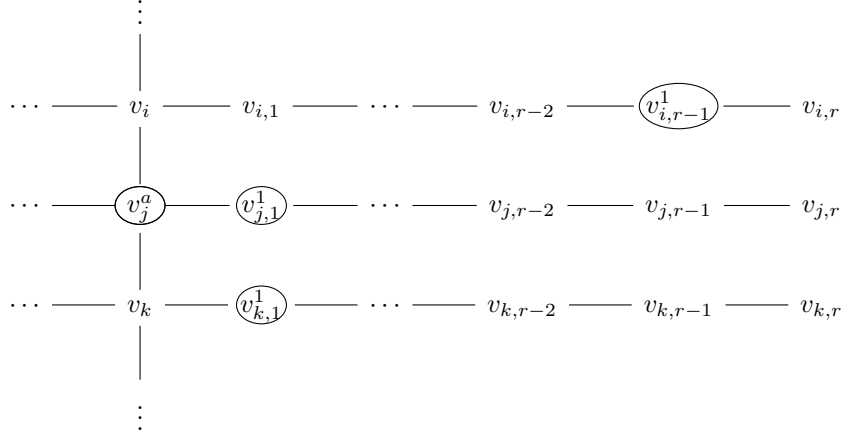

Then it is straightforward to show that

$$\mathfrak{P} := (V'', \delta'') := \{v_{i,r-1}^1, v_j^a, v_{j,1}^1, v_{k,1}^1\} \sqcup \{v_m^1 \mid m \in \{1, \dots, d\} \setminus \{i, j, k\}\}$$

is an  $f$ -weighted  $r$ -path vertex cover of  $(\Sigma_r G)_\lambda$  such that  $|V''| = d + 1$ ,

$$v_{i,r} \cdots v_{i,1} v_i \in \mathfrak{P}_{i,r-1}, \quad v_{i,r-2} \cdots v_i v_j v_k \in \mathfrak{P}_{j,0}, \quad v_{i,r-2} \cdots v_i v_j v_{j,1} \in \mathfrak{P}_{j,1}, \quad v_{k,r} \cdots v_{k,1} v_k \in \mathfrak{P}_{k,1},$$

and  $v_{t,r} \cdots v_{t,1} v_t \in \mathfrak{P}_{t,0}$  for any  $t \in \{1, \dots, d\} \setminus \{i, j, k\}$ .  $\square$

We discuss the necessary conditions for  $I_{r,f}((\Sigma_r G)_\lambda)$  to be unmixed for the case  $r = 2$ .

**Theorem 3.3.2.** *Let  $(\Sigma_2 G)_\lambda$  be a weighted 2-path suspension of  $G_\omega$ . If  $I_{2,f}((\Sigma_2 G)_\lambda)$  is unmixed, then the weight function  $\lambda$  satisfies the constraints in Proposition 3.2.1.*

*Proof.* By Lemma 3.3.1 and its proof, it is enough to show that if the constraints on 3-paths or 3-cycles are not satisfied, then there exists an  $f$ -weighted 2-path vertex cover  $\mathfrak{P} := (V'', \delta'')$  of  $(\Sigma_2 G)_\lambda$  such that  $|V''| = d + 1$  and  $\mathfrak{P}_{i,j} \neq \emptyset$  for each  $v_{i,j} \in V''$ . Without loss of generality, we assume that the weight function  $\lambda$  satisfies constraints in Lemma 3.3.1.

(a) Let  $v_i v_j v_k v_l$  be a 3-path in  $G_\omega$  such that  $f(\lambda(v_{j,1} v_j), \lambda(v_j v_i)) < \lambda(v_j v_k) =: b$ . Suppose that we have  $f(\lambda(v_k v_j), \lambda(v_k v_l)) < \lambda(v_j v_k) = b$ .



(1) Assume that  $f(\lambda(v_{k,1}v_k), \lambda(v_kv_l)) < b$ .

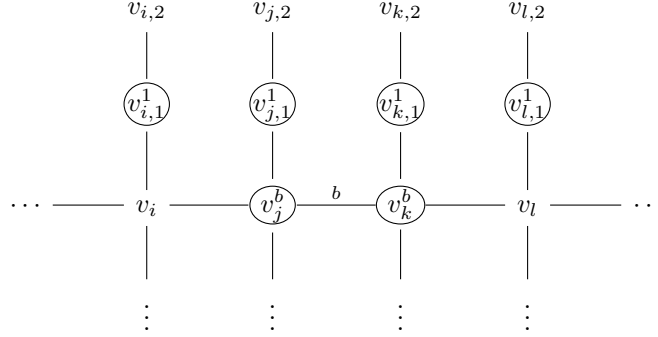

Then it is straightforward to show that

$$\mathfrak{P} := (V'', \delta'') := \{v_{i,1}^1, v_{j,1}^1, v_j^b, v_{k,1}^1, v_k^b, v_{l,1}^1\} \sqcup \{v_m^1 \mid m \in \{1, \dots, d\} \setminus \{i, j, k, l\}\}$$

is an  $f$ -weighted 2-path vertex cover of  $(\Sigma_2 G)_\lambda$ , and

$$v_{i,2}v_{i,1}v_i \in \mathfrak{P}_{i,1}, \quad v_{j,1}v_jv_i \in \mathfrak{P}_{j,1}, \quad v_jv_kv_l \in \mathfrak{P}_{j,0}, \quad v_{k,1}v_kv_l \in \mathfrak{P}_{k,1},$$

$$v_iv_jv_k \in \mathfrak{P}_{k,0}, \quad v_{l,2}v_{l,1}v_l \in \mathfrak{P}_{l,1}, \quad v_{t,2}v_{t,1}v_t \in \mathfrak{P}_{t,0}$$

for any  $t \in \{1, \dots, d\} \setminus \{i, j, k, l\}$ .

(2) Assume that  $f(\lambda(v_{k,1}v_k), \lambda(v_kv_l)) \geq b$ .

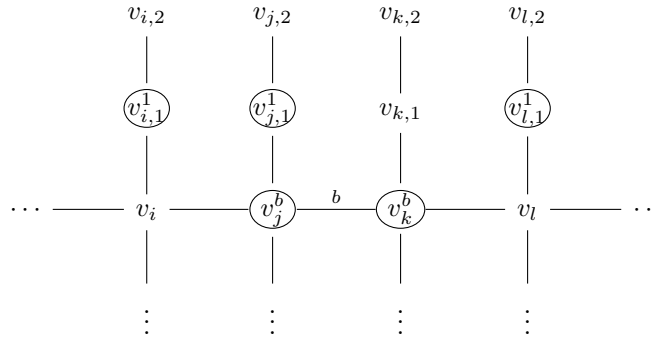

We have that  $\mathfrak{P} := (V'', \delta'') := \{v_{i,1}^1, v_{j,1}^1, v_j^b, v_k^b, v_{l,1}^1\} \sqcup \{v_m^1 \mid m \in \{1, \dots, d\} \setminus \{i, j, k, l\}\}$  is an  $f$ -weighted 2-path vertex cover of  $(\Sigma_2 G)_\lambda$ , and  $v_{i,2}v_{i,1}v_i \in \mathfrak{P}_{i,1}$ ,  $v_{j,1}v_jv_i \in \mathfrak{P}_{j,1}$ ,  $v_jv_kv_l \in \mathfrak{P}_{j,0}$ ,  $v_iv_jv_k \in \mathfrak{P}_{k,0}$ ,  $v_{l,2}v_{l,1}v_l \in \mathfrak{P}_{l,1}$ ,  $v_{t,2}v_{t,1}v_t \in \mathfrak{P}_{t,0}$  for any  $t \in \{1, \dots, d\} \setminus \{i, j, k, l\}$ .

(b) Let  $v_i v_j v_k v_i$  be a 3-cycle in  $G$  with  $f(\lambda(v_{i,1} v_i), \lambda(v_i v_j)) < \lambda(v_i v_k) =: a$ . Suppose that we have  $f(\lambda(v_k v_i), \lambda(v_k v_j)) < \lambda(v_k v_i) = a$  and  $f(\lambda(v_k v_i), \lambda(v_k v_j)) < \lambda(v_k v_j) =: b$ . So we have that  $f(\lambda(v_k v_i), \lambda(v_k v_j)) < \min\{a, b\} =: c$ .

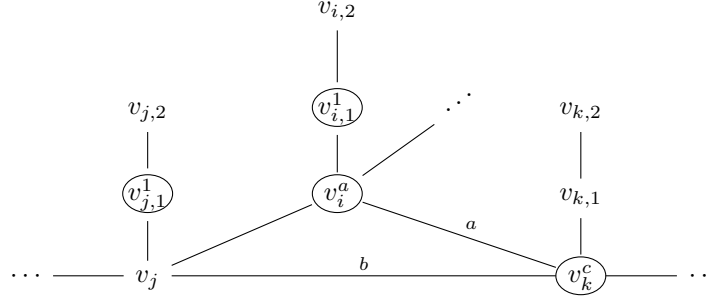

Then it is straightforward to show that

$$\mathfrak{P} := (V'', \delta'') := \{v_{j,1}^1, v_{i,1}^1, v_i^a, v_k^c\} \sqcup \{v_m^1 \mid m \in \{1, \dots, d\} \setminus \{i, j, k\}\}$$

is an  $f$ -weighted 2-path vertex cover of  $(\Sigma_2 G)_\lambda$ , and for any  $t \in \{1, \dots, d\} \setminus \{i, j, k\}$ ,

$$v_{j,2} v_{j,1} v_j \in \mathfrak{P}_{j,1}, \quad v_{i,1} v_i v_j \in \mathfrak{P}_{i,1}, \quad v_i v_k v_j \in \mathfrak{P}_{i,0}, \quad v_{k,2} v_{k,1} v_k \in \mathfrak{P}_{k,0}, \quad v_{t,2} v_{t,1} v_t \in \mathfrak{P}_{t,0}.$$

(c) Let  $v_i v_j v_k v_i$  be a 3-cycle in  $G$  with  $f(\lambda(v_{i,1} v_i), \lambda(v_i v_j)) < \lambda(v_i v_k) =: a$ . Suppose that we have  $f(\lambda(v_k v_i), \lambda(v_k v_j)) < \lambda(v_k v_i) = a$  and  $b := f(\lambda(v_j v_i), \lambda(v_j v_k)) > \max\{\lambda(v_j v_i), \lambda(v_j v_k)\}$ .

(1) Assume that  $f(\lambda(v_{k,1} v_k), \lambda(v_k v_j)) < a$ .

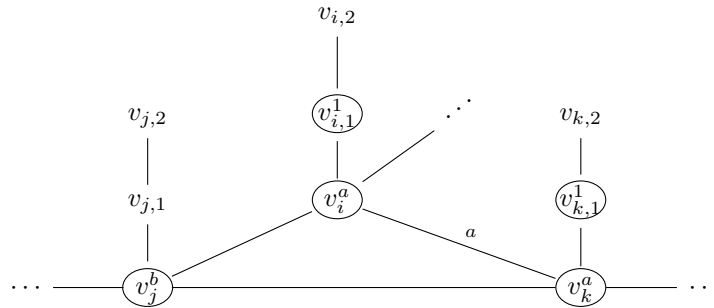

It is straightforward to show that

$$\mathfrak{P} := (V'', \delta'') := \{v_j^b, v_{i,1}^1, v_i^a, v_k^a, v_{k,1}^1\} \sqcup \{v_m^1 \mid m \in \{1, \dots, d\} \setminus \{i, j, k\}\}$$

is an  $f$ -weighted 2-path vertex cover of  $(\Sigma_2 G)_\lambda$ , and

$$v_{j,2}v_{j,1}v_j \in \mathfrak{P}_{j,0}, v_{i,1}v_i v_j \in \mathfrak{P}_{i,1}, v_i v_k v_j \in \mathfrak{P}_{i,0}, v_j v_i v_k \in \mathfrak{P}_{k,0}, v_{k,1}v_k v_j \in \mathfrak{P}_{k,1}, v_{t,2}v_{t,1}v_t \in \mathfrak{P}_{t,0}$$

for any  $t \in \{1, \dots, d\} \setminus \{i, j, k\}$ .

(2) Assume that  $f(\lambda(v_{k,1}v_k), \lambda(v_k v_j)) \geq a$ .

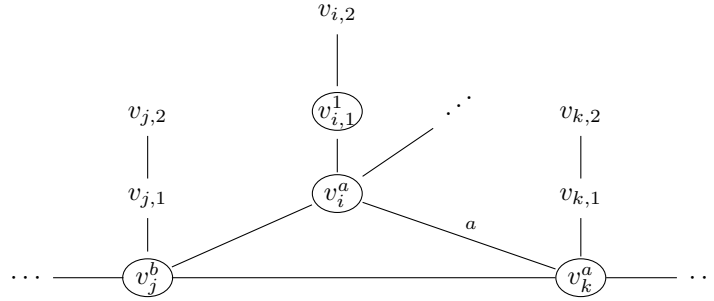

It is straightforward to show that

$$\mathfrak{P} := (V'', \delta'') := \{v_j^b, v_{i,1}^1, v_i^a, v_k^a\} \sqcup \{v_m^1 \mid m \in \{1, \dots, d\} \setminus \{i, j, k\}\}$$

is an  $f$ -weighted 2-path vertex cover of  $(\Sigma_2 G)_\lambda$ , and

$$v_{j,2}v_{j,1}v_j \in \mathfrak{P}_{j,0}, v_{i,1}v_i v_j \in \mathfrak{P}_{i,1}, v_i v_k v_j \in \mathfrak{P}_{i,0}, v_j v_i v_k \in \mathfrak{P}_{k,0}, v_{t,2}v_{t,1}v_t \in \mathfrak{P}_{t,0}$$

for any  $t \in \{1, \dots, d\} \setminus \{i, j, k\}$ . □

We discuss the necessary conditions for  $I_{r,f}((\Sigma_r G)_\lambda)$  to be unmixed for the case  $r = 3$ .

**Theorem 3.3.3.** *Let  $(\Sigma_3 G)_\lambda$  be a weighted 3-path suspension of  $G_\omega$ . If  $I_{3,f}((\Sigma_3 G)_\lambda)$  is unmixed, then the weight function  $\lambda$  satisfies the constraints in Proposition 3.2.43.*

*Proof.* By Lemma 3.3.1 and its proof, it is enough to show that if the constraints on 4-paths or 3-cycles or 4-cycles are not satisfied, then there exists an  $f$ -weighted 3-path vertex cover  $\mathfrak{P} := (V'', \delta'')$  of  $(\Sigma_3 G)_\lambda$  such that  $|V''| = d + 1$  and  $\mathfrak{P}_{i,j} \neq \emptyset$  for each  $v_{i,j} \in V''$ . Without loss of generality, we assume that the weight function  $\lambda$  satisfies the constraints in Lemma 3.3.1.

(a) Let  $v_i v_j v_k v_l v_m$  be a 4-path in  $G$  such that  $f(\lambda(v_{j,1}v_j), \lambda(v_j v_i)) < \lambda(v_j v_k) =: a$ . Suppose that  $f(\lambda(v_i v_j), \lambda(v_j v_k)) < \lambda(v_j v_k) = a$  and  $f(\lambda(v_k v_l), \lambda(v_l v_m)) < \lambda(v_k v_l) =: b$ .

(1) Assume that  $f(\lambda(v_{l,1}v_l), \lambda(v_lv_m)) < b$ .

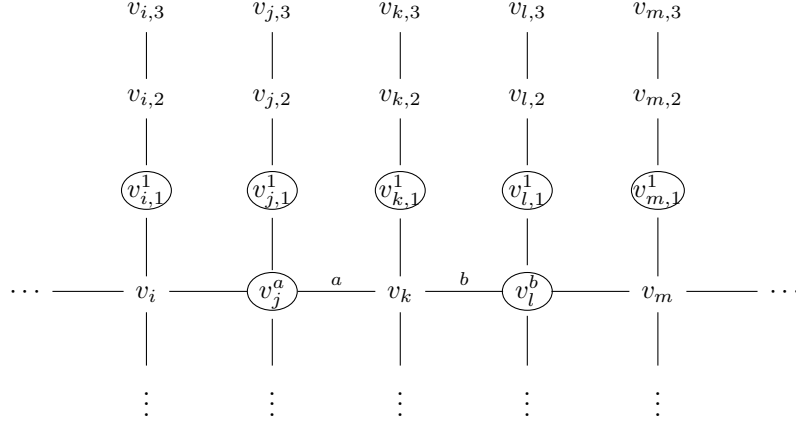

Then it is straightforward to show that

$$\mathfrak{P} := (V'', \delta'') := \{v_{i,1}^1, v_{j,1}^1, v_j^a, v_{k,1}^1, v_{l,1}^1, v_l^b, v_{m,1}^1\} \sqcup \{v_n^1 \mid n \in \{1, \dots, d\} \setminus \{i, j, k, l, m\}\}$$

is an  $f$ -weighted 3-path vertex cover of  $(\Sigma_3 G)_\lambda$ , and

$$v_{i,3}v_{i,2}v_{i,1}v_i \in \mathfrak{P}_{i,1}, \quad v_{j,2}v_{j,1}v_jv_i \in \mathfrak{P}_{j,1}, \quad v_jv_kv_lv_m \in \mathfrak{P}_{j,0}, \quad v_{k,3}v_{k,2}v_{k,1}v_k \in \mathfrak{P}_{k,1},$$

$$v_{l,2}v_{l,1}v_lv_m \in \mathfrak{P}_{l,1}, \quad v_iv_jv_kv_l \in \mathfrak{P}_{l,0}, \quad v_{m,3}v_{m,2}v_{m,1}v_m \in \mathfrak{P}_{m,1}, \quad v_{t,3}v_{t,2}v_{t,1}v_t \in \mathfrak{P}_{t,0}$$

for any  $t \in \{1, \dots, d\} \setminus \{i, j, k, l, m\}$ .

(2) Assume that  $f(\lambda(v_{l,1}v_l), \lambda(v_lv_m)) \geq b$ .

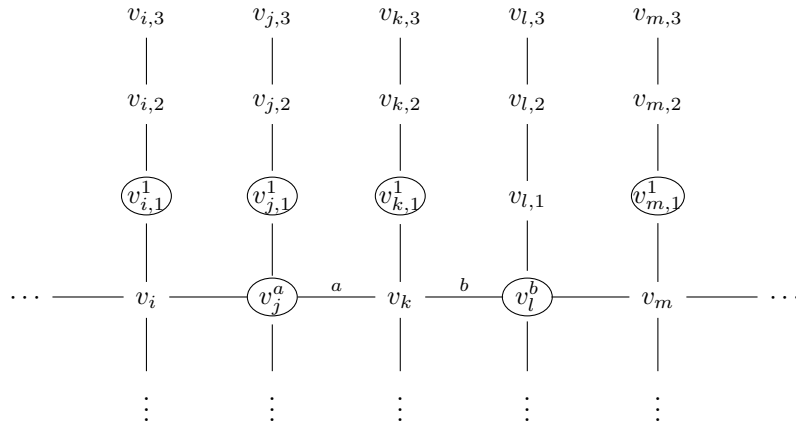

Then it is straightforward to show that

$$\mathfrak{P} := (V'', \delta'') := \{v_{i,1}^1, v_{j,1}^1, v_j^a, v_{k,1}^1, v_l^b, v_{m,1}^1\} \sqcup \{v_n^1 \mid n \in \{1, \dots, d\} \setminus \{i, j, k, l, m\}\}$$

is an  $f$ -weighted 3-path vertex cover of  $(\Sigma_3 G)_\lambda$ , and

$$v_{i,3}v_{i,2}v_{i,1}v_i \in \mathfrak{P}_{i,1}, \quad v_{j,2}v_{j,1}v_jv_i \in \mathfrak{P}_{j,1}, \quad v_jv_kv_lv_m \in \mathfrak{P}_{j,0}, \quad v_{k,3}v_{k,2}v_{k,1}v_k \in \mathfrak{P}_{k,1},$$

$$v_i v_j v_k v_l \in \mathfrak{P}_{l,0}, \quad v_{m,3}v_{m,2}v_{m,1}v_m \in \mathfrak{P}_{m,1}, \quad v_{t,3}v_{t,2}v_{t,1}v_t \in \mathfrak{P}_{t,0}$$

for any  $t \in \{1, \dots, d\} \setminus \{i, j, k, l, m\}$ .

(b) Let  $v_i v_j v_k v_l v_m$  be a 4-path in  $G$  such that  $f(\lambda(v_{k,1}v_k), \lambda(v_k v_j)) < \lambda(v_k v_l) =: b$ . Suppose that  $f(\lambda(v_j v_k), \lambda(v_j v_i)) < \lambda(v_j v_k) =: a$  and  $f(\lambda(v_k v_l), \lambda(v_l v_m)) < \lambda(v_k v_l) = b$ .

(1) Assume that  $f(\lambda(v_{j,1}v_j), \lambda(v_j v_i)) < a$  and  $f(\lambda(v_{l,1}v_l), \lambda(v_l v_m)) < b$ .

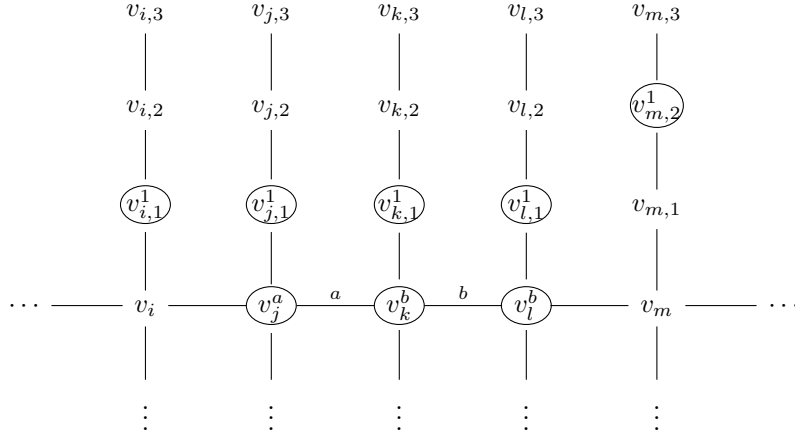

Then it is straightforward to show that

$$\mathfrak{P} := (V'', \delta'') := \{v_{i,1}^1, v_{j,1}^1, v_j^a, v_{k,1}^1, v_k^b, v_{l,1}^1, v_l^b, v_{m,2}^1\} \sqcup \{v_n^1 \mid n \in \{1, \dots, d\} \setminus \{i, j, k, l, m\}\}$$

is an  $f$ -weighted 3-path vertex cover of  $(\Sigma_3 G)_\lambda$ , and

$$v_{i,3}v_{i,2}v_{i,1}v_i \in \mathfrak{P}_{i,1}, \quad v_{j,2}v_{j,1}v_jv_i \in \mathfrak{P}_{j,1}, \quad v_jv_kv_lv_m \in \mathfrak{P}_{j,0}, \quad v_{k,1}v_kv_jv_i \in \mathfrak{P}_{k,1}, \quad v_kv_lv_mv_{m,1} \in \mathfrak{P}_{k,0},$$

$$v_{l,2}v_{l,1}v_l v_m \in \mathfrak{P}_{l,1}, \quad v_i v_j v_k v_l \in \mathfrak{P}_{l,0}, \quad v_{m,3}v_{m,2}v_{m,1}v_m \in \mathfrak{P}_{m,2}, \quad v_{t,3}v_{t,2}v_{t,1}v_t \in \mathfrak{P}_{t,0}$$

for any  $t \in \{1, \dots, d\} \setminus \{i, j, k, l, m\}$ .

(2) Assume that  $f(\lambda(v_{j,1}v_j), \lambda(v_j v_i)) \geq a$  and  $f(\lambda(v_{l,1}v_l), \lambda(v_l v_m)) < b$ .

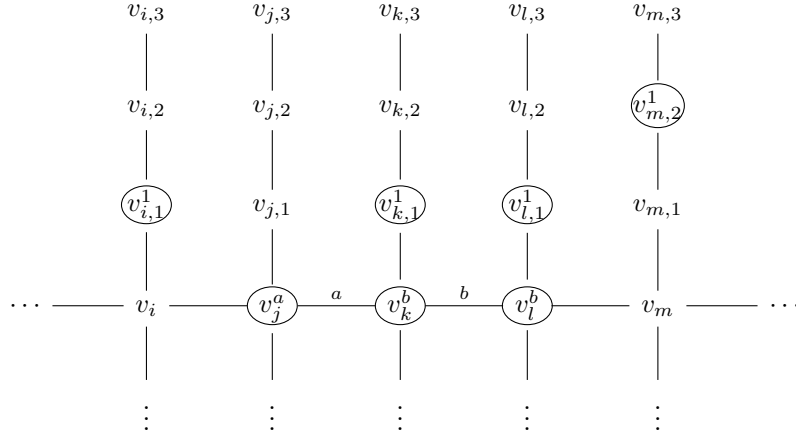

Then it is straightforward to show that

$$\mathfrak{P} := (V'', \delta'') := \{v_{i,1}^1, v_j^a, v_{k,1}^1, v_k^b, v_{l,1}^1, v_l^b, v_{m,2}^1\} \sqcup \{v_n^1 \mid n \in \{1, \dots, d\} \setminus \{i, j, k, l, m\}\}$$

is an  $f$ -weighted 3-path vertex cover of  $(\Sigma_3 G)_\lambda$ , and for any  $t \in \{1, \dots, d\} \setminus \{i, j, k, l, m\}$ ,

$$\begin{aligned} v_{i,3}v_{i,2}v_{i,1}v_i &\in \mathfrak{P}_{i,1}, \quad v_j v_k v_l v_m \in \mathfrak{P}_{j,0}, \quad v_{k,1}v_k v_j v_i \in \mathfrak{P}_{k,1}, \quad v_k v_l v_m v_{m,1} \in \mathfrak{P}_{k,0}, \\ v_{l,2}v_{l,1}v_l v_m &\in \mathfrak{P}_{l,1}, \quad v_i v_j v_k v_l \in \mathfrak{P}_{l,0}, \quad v_{m,3}v_{m,2}v_{m,1}v_m \in \mathfrak{P}_{m,2}, \quad v_{t,3}v_{t,2}v_{t,1}v_t \in \mathfrak{P}_{t,0}. \end{aligned}$$

(3) Assume that  $f(\lambda(v_{j,1}v_j), \lambda(v_j v_i)) < a$  and  $f(\lambda(v_{l,1}v_l), \lambda(v_l v_m)) \geq b$ .

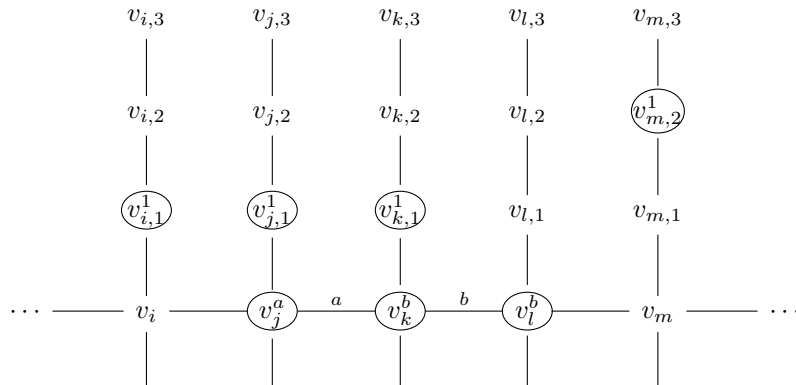

Then it is straightforward to show that

$$\mathfrak{P} := (V'', \delta'') := \{v_{i,1}^1, v_{j,1}^1, v_j^a, v_{k,1}^1, v_k^b, v_l^b, v_{m,2}^1\} \sqcup \{v_n^1 \mid n \in \{1, \dots, d\} \setminus \{i, j, k, l, m\}\}$$

is an  $f$ -weighted 3-path vertex cover of  $(\Sigma_3 G)_\lambda$ , and

$$v_{i,3}v_{i,2}v_{i,1}v_i \in \mathfrak{P}_{i,1}, \quad v_{j,2}v_{j,1}v_jv_i \in \mathfrak{P}_{j,1}, \quad v_jv_kv_lv_m \in \mathfrak{P}_{j,0}, \quad v_{k,1}v_kv_jv_i \in \mathfrak{P}_{k,1},$$

$$v_kv_lv_mv_{m,1} \in \mathfrak{P}_{k,0}, \quad v_iv_jv_kv_l \in \mathfrak{P}_{l,0}, \quad v_{m,3}v_{m,2}v_{m,1}v_m \in \mathfrak{P}_{m,2}, \quad v_{t,3}v_{t,2}v_{t,1}v_t \in \mathfrak{P}_{t,0}$$

for any  $t \in \{1, \dots, d\} \setminus \{i, j, k, l, m\}$ .

(4) Assume that  $f(\lambda(v_{j,1}v_j), \lambda(v_jv_i)) \geq a$  and  $f(\lambda(v_{l,1}v_l), \lambda(v_lv_m)) \geq b$ .

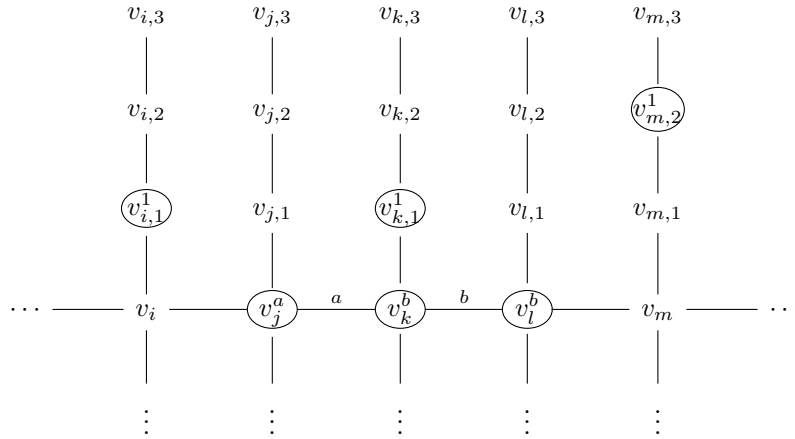

Then it is straightforward to show that

$$\mathfrak{P} := (V'', \delta'') := \{v_{i,1}^1, v_j^a, v_{k,1}^1, v_k^b, v_l^b, v_{m,2}^1\} \sqcup \{v_n^1 \mid n \in \{1, \dots, d\} \setminus \{i, j, k, l, m\}\}$$

is an  $f$ -weighted 3-path vertex cover of  $(\Sigma_3 G)_\lambda$ , and

$$v_{i,3}v_{i,2}v_{i,1}v_i \in \mathfrak{P}_{i,1}, \quad v_jv_kv_lv_m \in \mathfrak{P}_{j,0}, \quad v_{k,1}v_kv_jv_i \in \mathfrak{P}_{k,1}, \quad v_kv_lv_mv_{m,1} \in \mathfrak{P}_{k,0},$$

$$v_iv_jv_kv_l \in \mathfrak{P}_{l,0}, \quad v_{m,3}v_{m,2}v_{m,1}v_m \in \mathfrak{P}_{m,2}, \quad v_{t,3}v_{t,2}v_{t,1}v_t \in \mathfrak{P}_{t,0}$$

for any  $t \in \{1, \dots, d\} \setminus \{i, j, k, l, m\}$ .

(c) Let  $v_i v_j v_k$  be a 3-cycle in  $G$  such that  $f(\lambda(v_i v_i, \lambda(v_i v_j))) < f(\lambda(v_i v_i, \lambda(v_i v_k))) =: a$ . Suppose that  $b := f(\lambda(v_j v_i), \lambda(v_j v_k)) > \max\{\lambda(v_j v_i), \lambda(v_j v_k)\}$

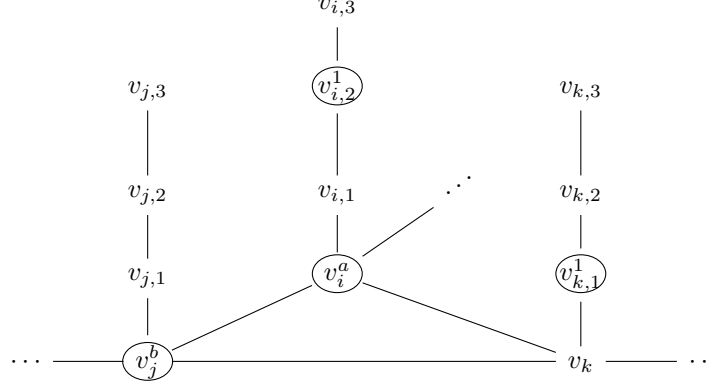

Then it is straightforward to show that

$$\mathfrak{P} := (V'', \delta'') := \{v_j^b, v_{i,2}^1, v_i^a, v_{k,1}^1\} \sqcup \{v_m^1 \mid m \in \{1, \dots, d\} \setminus \{i, j, k\}\}$$

is an  $f$ -weighted 3-path vertex cover of  $(\Sigma_3 G)_\lambda$ , and

$$v_{i,1} v_i v_j v_k \in \mathfrak{P}_{j,0}, \quad v_{i,2} v_{i,1} v_i v_j \in \mathfrak{P}_{i,2}, \quad v_{i,1} v_i v_k v_j \in \mathfrak{P}_{i,0}, \quad v_{k,3} v_{k,2} v_{k,1} v_k \in \mathfrak{P}_{k,1}, \quad v_{t,3} v_{t,2} v_{t,1} v_t \in \mathfrak{P}_{t,0}$$

for any  $t \in \{1, \dots, d\} \setminus \{i, j, k\}$ .

(d) Let  $v_i v_j v_k$  be a 3-cycle in  $G$  such that  $f(\lambda(v_i v_i, \lambda(v_i v_j))) < f(\lambda(v_i v_i, \lambda(v_i v_k))) =: a$ . Suppose that  $f(\lambda(v_k v_i), \lambda(v_k v_j)) < \lambda(v_k v_j) =: b$ .

(1) Assume that  $\lambda(v_i v_k) < a$  and  $f(\lambda(v_{k,1} v_k), \lambda(v_k v_i)) < b$ .

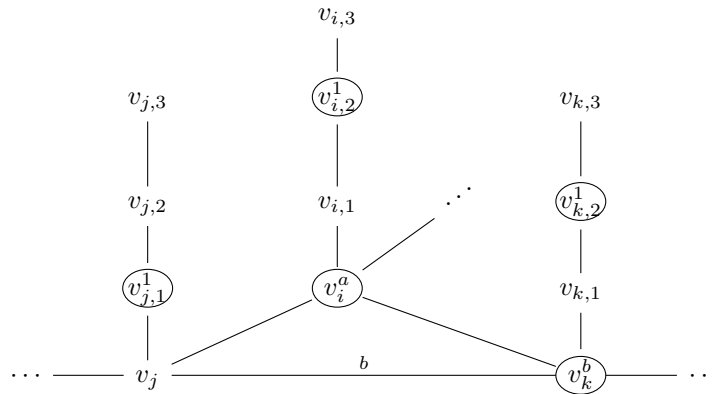



Then it is straightforward to show that

$$\mathfrak{P} := (V'', \delta'') := \{v_{j,1}^1, v_{i,2}^1, v_i^a, v_{k,2}^1, v_k^b\} \sqcup \{v_m^1 \mid m \in \{1, \dots, d\} \setminus \{i, j, k\}\}$$

is an  $f$ -weighted 3-path vertex cover of  $(\Sigma_3 G)_\lambda$ , and

$$v_{j,1}v_jv_iv_{i,1} \in \mathfrak{P}_{j,1}, \quad v_{i,2}v_{i,1}v_iv_j \in \mathfrak{P}_{i,2}, \quad v_{i,1}v_iv_kv_j \in \mathfrak{P}_{i,0},$$

$$v_iv_kv_{k,1}v_{k,2} \in \mathfrak{P}_{k,2}, \quad v_{i,1}v_iv_jv_k \in \mathfrak{P}_{k,0}, \quad v_{t,3}v_{t,2}v_{t,1}v_t \in \mathfrak{P}_{t,0}$$

for any  $t \in \{1, \dots, d\} \setminus \{i, j, k\}$ .

(2) Assume that  $\lambda(v_iv_k) \geq a$  or  $f(\lambda(v_{k,1}v_k), \lambda(v_kv_i)) \geq b$ .

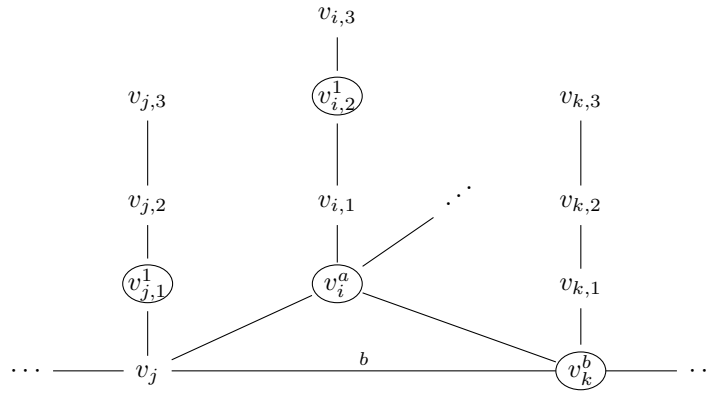

Then it is straightforward to show that

$$\mathfrak{P} := (V'', \delta'') := \{v_{j,1}^1, v_{i,2}^1, v_i^a, v_k^b\} \sqcup \{v_m^1 \mid m \in \{1, \dots, d\} \setminus \{i, j, k\}\}$$

is an  $f$ -weighted 3-path vertex cover of  $(\Sigma_3 G)_\lambda$ , and

$$v_{j,1}v_jv_iv_{i,1} \in \mathfrak{P}_{j,1}, \quad v_{i,2}v_{i,1}v_iv_j \in \mathfrak{P}_{i,2}, \quad v_{i,1}v_iv_kv_j \in \mathfrak{P}_{i,0}, \quad v_{i,1}v_iv_jv_k \in \mathfrak{P}_{k,0}, \quad v_{t,3}v_{t,2}v_{t,1}v_t \in \mathfrak{P}_{t,0}$$

for any  $t \in \{1, \dots, d\} \setminus \{i, j, k\}$ .

(e) Let  $v_iv_jv_k$  be a 3-cycle in  $G$  such that  $f(\lambda(v_iv_{i,1}), \lambda(v_iv_j)) < f(\lambda(v_iv_i), \lambda(v_iv_k)) =: a$  for some

$v_i v_l \in E(G)$  with  $j \neq l \neq k$ . Suppose that  $b := f(\lambda(v_j v_i), \lambda(v_j v_k)) > \max\{\lambda(v_j v_i), \lambda(v_j v_k)\}$ .

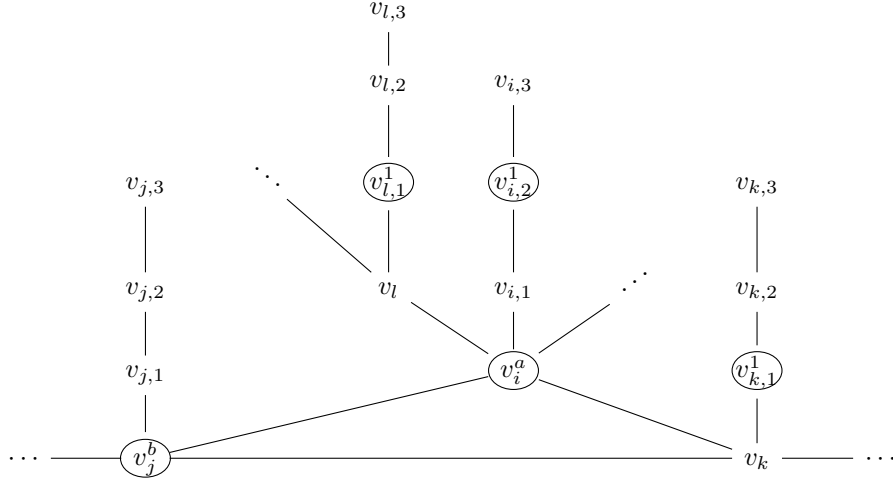

Then it is straightforward to show that

$$\mathfrak{P} := (V'', \delta'') := \{v_j^b, v_{i,2}^1, v_i^a, v_{k,1}^1, v_{l,1}^1\} \sqcup \{v_m^1 \mid m \in \{1, \dots, d\} \setminus \{i, j, k, l\}\}$$

is an  $f$ -weighted 3-path vertex cover of  $(\Sigma_3 G)_\lambda$  and that  $v_{i,1} v_i v_j v_k \in \mathfrak{P}_{j,0}$ ,  $v_{i,2} v_{i,1} v_i v_j \in \mathfrak{P}_{i,2}$ ,  $v_l v_i v_k v_j \in \mathfrak{P}_{i,0}$ ,  $v_{k,3} v_{k,2} v_{k,1} v_k \in \mathfrak{P}_{k,1}$ , and  $v_{t,3} v_{t,2} v_{t,1} v_t \in \mathfrak{P}_{t,0}$  for any  $t \in \{1, \dots, d\} \setminus \{i, j, k, l\}$ .

(f) Let  $v_i v_j v_k$  be a 3-cycle in  $G$  such that  $f(\lambda(v_i v_{i,1}), \lambda(v_i v_j)) < f(\lambda(v_i v_l), \lambda(v_i v_k)) =: a$  for some  $v_i v_l \in E(G)$  with  $j \neq l \neq k$ . Suppose that  $f(\lambda(v_k v_i), \lambda(v_k v_j)) < \lambda(v_k v_j) =: b$ .

(1) Assume that  $\lambda(v_i v_k) < a$  and  $f(\lambda(v_{k,1} v_k), \lambda(v_k v_i)) < b$ .

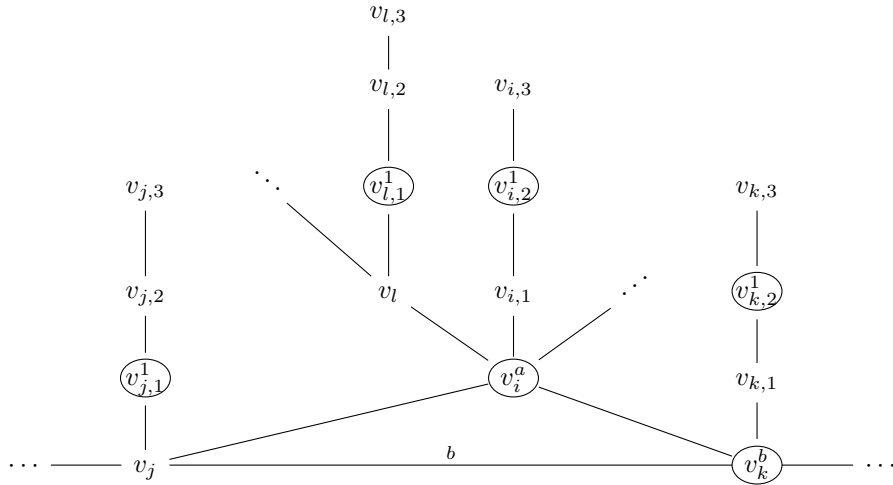

Then it is straightforward to show that

$$\mathfrak{P} := (V'', \delta'') := \{v_{j,1}^1, v_{i,2}^1, v_i^a, v_{k,1}^1, v_k^b, v_{l,1}^1\} \sqcup \{v_m^1 \mid m \in \{1, \dots, d\} \setminus \{i, j, k, l\}\}$$

is an  $f$ -weighted 3-path vertex cover of  $(\Sigma_3 G)_\lambda$ , and

$$v_{j,1}v_jv_i v_{i,1} \in \mathfrak{P}_{j,1}, \quad v_{i,2}v_{i,1}v_i v_j \in \mathfrak{P}_{i,2}, \quad v_l v_i v_k v_j \in \mathfrak{P}_{i,0},$$

$$v_i v_k v_{k,1} v_{k,2} \in \mathfrak{P}_{k,2}, \quad v_{i,1}v_i v_j v_k \in \mathfrak{P}_{k,0}, \quad v_t v_3 v_t v_{t,1} v_t \in \mathfrak{P}_{t,0}$$

for any  $t \in \{1, \dots, d\} \setminus \{i, j, k, l\}$ .

(2) Assume that  $\lambda(v_i v_k) \geq a$  or  $f(\lambda(v_{k,1} v_k), \lambda(v_k v_i)) \geq b$ .

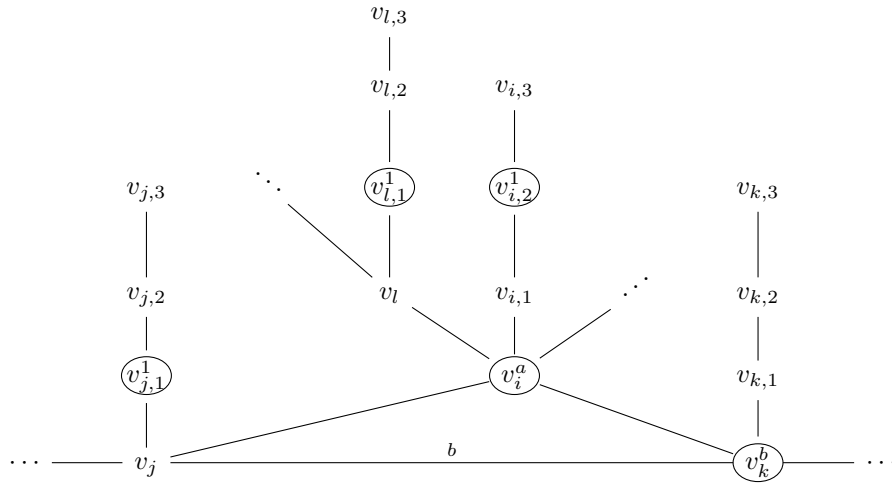

Then it is straightforward to show that

$$\mathfrak{P} := (V'', \delta'') := \{v_{j,1}^1, v_{i,2}^1, v_i^a, v_k^b, v_{l,1}^1\} \sqcup \{v_m^1 \mid m \in \{1, \dots, d\} \setminus \{i, j, k, l\}\}$$

is an  $f$ -weighted 3-path vertex cover of  $(\Sigma_3 G)_\lambda$ , and

$$v_{j,1}v_jv_i v_{i,1} \in \mathfrak{P}_{j,1}, \quad v_{i,2}v_{i,1}v_i v_j \in \mathfrak{P}_{i,2}, \quad v_l v_i v_k v_j \in \mathfrak{P}_{i,0}, \quad v_{i,1}v_i v_j v_k \in \mathfrak{P}_{k,0}, \quad v_t v_3 v_t v_{t,1} v_t \in \mathfrak{P}_{t,0}$$

for any  $t \in \{1, \dots, d\} \setminus \{i, j, k, l\}$ .

(g) Let  $v_i v_j v_k$  be a 3-cycle in  $G$  such that  $f(\lambda(v_i v_{i,1}), \lambda(v_i v_j)) < \lambda(v_i v_k) =: a$ . Suppose that we

have  $f(\lambda(v_k v_i), \lambda(v_k v_j)) < \lambda(v_k v_i) = a$ .

(1) Assume that  $f(\lambda(v_{k,1} v_k), \lambda(v_k v_j)) < a$ .

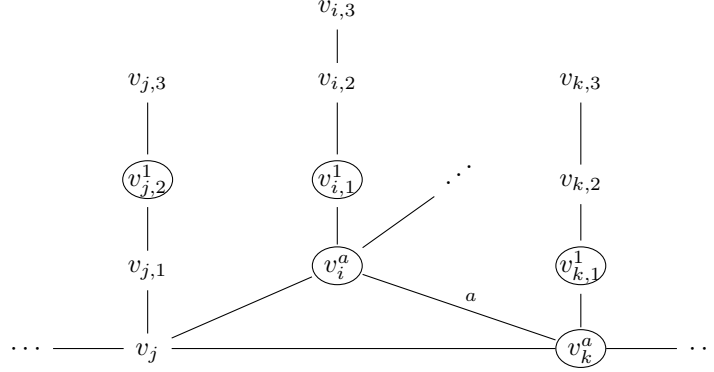

Then it is straightforward to show that

$$\mathfrak{P} := (V'', \delta'') := \{v_{j,2}^1, v_{i,1}^1, v_i^a, v_{k,1}^1, v_k^a\} \sqcup \{v_m^1 \mid m \in \{1, \dots, d\} \setminus \{i, j, k\}\}$$

is an  $f$ -weighted 3-path vertex cover of  $(\Sigma_3 G)_\lambda$ , and

$$v_{j,2} v_{j,1} v_j v_i \in \mathfrak{P}_{j,2}, \quad v_{i,1} v_i v_j v_{j,1} \in \mathfrak{P}_{i,1}, \quad v_i v_k v_j v_{j,1} \in \mathfrak{P}_{i,0},$$

$$v_{j,1} v_j v_k v_{k,1} \in \mathfrak{P}_{k,1}, \quad v_{j,1} v_j v_i v_k \in \mathfrak{P}_{k,0}, \quad v_t v_{t,2} v_{t,1} v_t \in \mathfrak{P}_{t,0}$$

for any  $t \in \{1, \dots, d\} \setminus \{i, j, k\}$ .

(2) Assume that  $f(\lambda(v_{k,1} v_k), \lambda(v_k v_j)) \geq a$ .

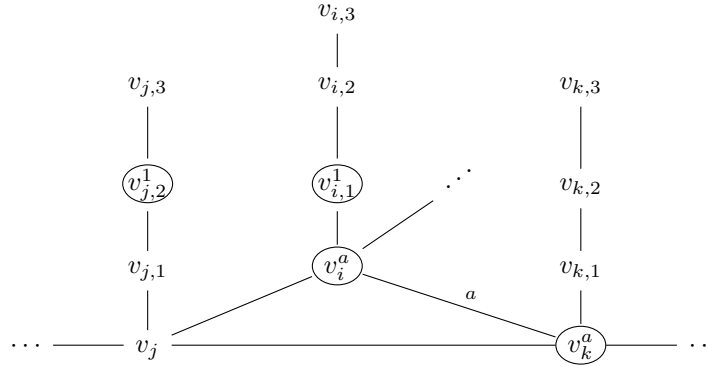

Then it is straightforward to show that

$$\mathfrak{P} := (V'', \delta'') := \{v_{j,2}^1, v_{i,1}^1, v_i^a, v_k^a\} \sqcup \{v_m^1 \mid m \in \{1, \dots, d\} \setminus \{i, j, k\}\}$$

is an  $f$ -weighted 3-path vertex cover of  $(\Sigma_3 G)_\lambda$ , and

$$v_{j,2}v_{j,1}v_jv_i \in \mathfrak{P}_{j,2}, \quad v_{i,1}v_iv_jv_{j,1} \in \mathfrak{P}_{i,1}, \quad v_iv_kv_jv_{j,1} \in \mathfrak{P}_{i,0}, \quad v_{j,1}v_jv_iv_k \in \mathfrak{P}_{k,0}, \quad v_{t,3}v_{t,2}v_{t,1}v_t \in \mathfrak{P}_{t,0}$$

for any  $t \in \{1, \dots, d\} \setminus \{i, j, k\}$ .

(h) Let  $v_iv_jv_k$  be a 3-cycle in  $G$  such that  $f(\lambda(v_iv_{i,1}), \lambda(v_iv_j)) < \lambda(v_iv_k) =: a$  and there exists  $v_jv_{l_1, l_2} \in E((\Sigma_3 G)_\lambda)$  with  $v_i \neq v_{l_1, l_2} \neq v_k$ . Suppose

$$b := f(\lambda(v_jv_i), \lambda(v_jv_{l_1, l_2})) > \max\{\lambda(v_jv_i), f(\lambda(v_jv_k), \lambda(v_jv_{l_1, l_2}))\}.$$

(1) Assume that  $l_1 = j$ , then  $l_2 = 1$ .

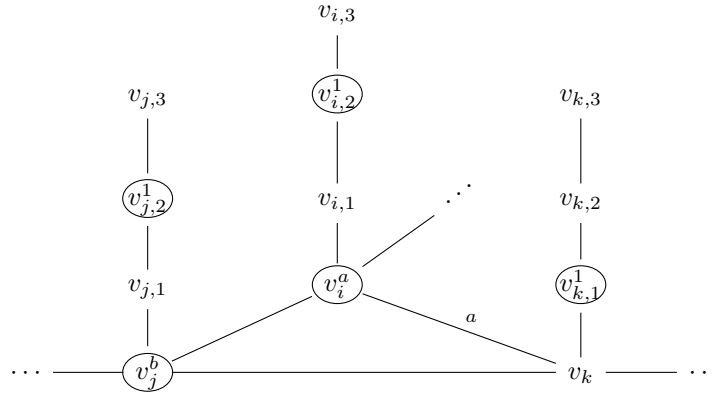

Then it is straightforward to show that

$$\mathfrak{P} := (V'', \delta'') := \{v_{j,2}^1, v_j^b, v_{i,2}^1, v_i^a, v_{k,1}^1\} \sqcup \{v_m^1 \mid m \in \{1, \dots, d\} \setminus \{i, j, k\}\}$$

is an  $f$ -weighted 3-path vertex cover of  $(\Sigma_3 G)_\lambda$ , and

$$\begin{aligned} v_{j,2}v_{j,1}v_jv_k &\in \mathfrak{P}_{j,2}, \quad v_{j,1}v_jv_iv_k \in \mathfrak{P}_{j,0}, \quad v_{i,2}v_{i,1}v_iv_j \in \mathfrak{P}_{i,2}, \\ v_iv_kv_jv_{j,1} &\in \mathfrak{P}_{i,0}, \quad v_{k,3}v_{k,2}v_{k,1}v_k \in \mathfrak{P}_{k,0}, \quad v_{t,3}v_{t,2}v_{t,1}v_t \in \mathfrak{P}_{t,0} \end{aligned}$$

for any  $t \in \{1, \dots, d\} \setminus \{i, j, k\}$ .

(2) Assume that  $l_1 \neq j$ , then  $l_2 = 0$ .

(i) Assume that  $f(\lambda(v_{j,1}v_j), \lambda(v_jv_k)) < b$ .

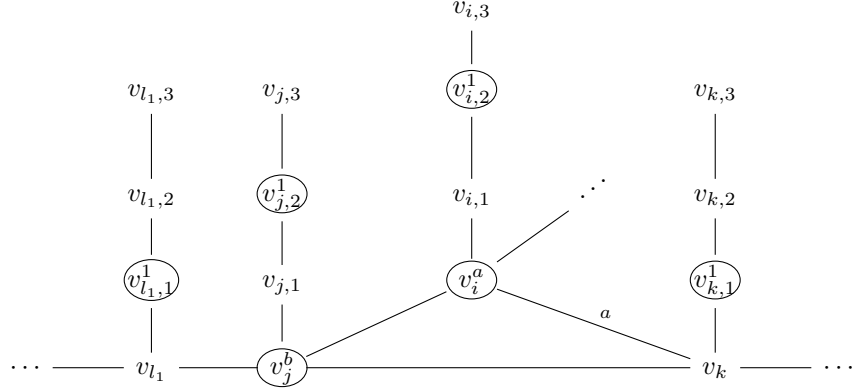

Then it is straightforward to show that

$$\mathfrak{P} := (V'', \delta'') := \{v_{l_1,1}^1, v_{j,2}^1, v_j^b, v_{i,2}^1, v_i^a, v_{k,1}^1\} \sqcup \{v_m^1 \mid m \in \{1, \dots, d\} \setminus \{i, j, k, l_1\}\}$$

is an  $f$ -weighted 3-path vertex cover of  $(\Sigma_3 G)_\lambda$ , and

$$v_{l_1,3}v_{l_1,2}v_{l_1,1}v_{l_1} \in \mathfrak{P}_{l_1,0}, \quad v_{j,2}v_{j,1}v_jv_k \in \mathfrak{P}_{j,2}, \quad v_{l_1}v_jv_iv_k \in \mathfrak{P}_{j,0}, \quad v_{i,2}v_{i,1}v_iv_j \in \mathfrak{P}_{i,2},$$

$$v_iv_kv_jv_{j,1} \in \mathfrak{P}_{i,0}, \quad v_{l_1}v_jv_kv_{k,1} \in \mathfrak{P}_{k,1}, \quad v_{t,3}v_{t,2}v_{t,1}v_t \in \mathfrak{P}_{t,0}$$

for any  $t \in \{1, \dots, d\} \setminus \{i, j, k, l\}$ .

(ii) Assume that  $f(\lambda(v_{j,1}v_j), \lambda(v_jv_k)) \geq b$ .

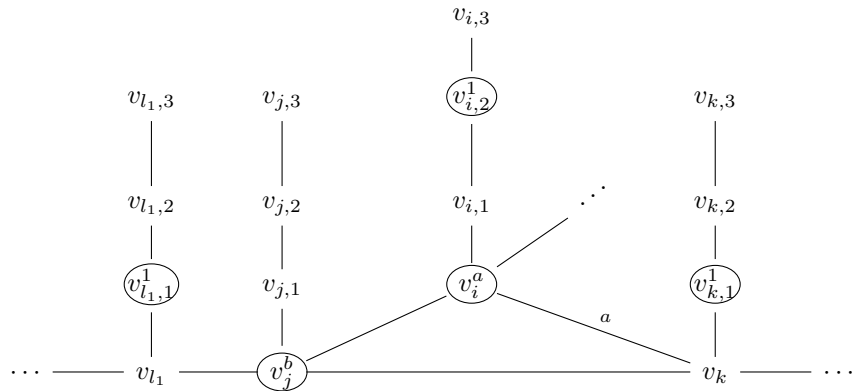

Then it is straightforward to show that

$$\mathfrak{P} := (V'', \delta'') := \{v_{l_1,1}^1, v_j^b, v_{i,2}^1, v_i^a, v_{k,1}^1\} \sqcup \{v_m^1 \mid m \in \{1, \dots, d\} \setminus \{i, j, k, l_1\}\}$$

is an  $f$ -weighted 3-path vertex cover of  $(\Sigma_3 G)_\lambda$ , and for any  $t \in \{1, \dots, d\} \setminus \{i, j, k, l_1\}$ ,

$$v_{l_1,3}v_{l_1,2}v_{l_1,1}v_{l_1} \in \mathfrak{P}_{l_1,0}, \quad v_{l_1}v_jv_iv_k \in \mathfrak{P}_{j,0}, \quad v_{i,2}v_{i,1}v_iv_j \in \mathfrak{P}_{i,2},$$

$$v_iv_kv_jv_{j,1} \in \mathfrak{P}_{i,0}, \quad v_{l_1}v_jv_kv_{k,1} \in \mathfrak{P}_{k,1}, \quad v_{t,3}v_{t,2}v_{t,1}v_t \in \mathfrak{P}_{t,0}.$$

(i) Let  $v_iv_jv_k$  be a 3-cycle in  $G$  such that  $f(\lambda(v_iv_{i,1}), \lambda(v_iv_j)) < \lambda(v_iv_k) =: a$  and there exists  $v_jv_{l_1,l_2} \in E((\Sigma_3 G)_\lambda)$  with  $v_i \neq v_{l_1,l_2} \neq v_k$ . Suppose that

$$b := f(\lambda(v_jv_i), \lambda(v_jv_{l_1,l_2})) > \max\{f(\lambda(v_jv_i), \lambda(v_jv_k)), f(\lambda(v_jv_k), \lambda(v_jv_{l_1,l_2}))\}.$$

(1) Assume that  $l_1 = j$ , then  $l_2 = 1$ .

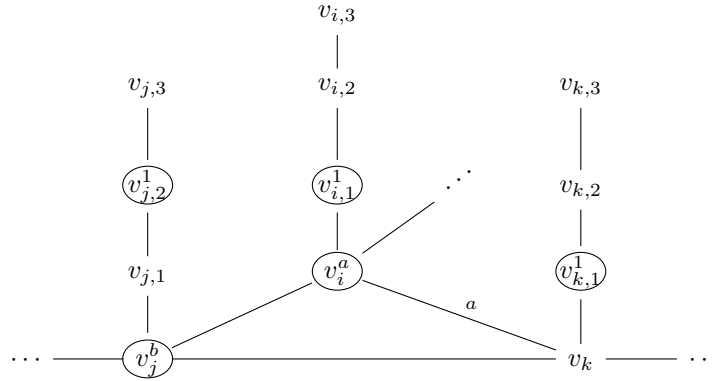

Then it is straightforward to show that

$$\mathfrak{P} := (V'', \delta'') := \{v_{j,2}^1, v_j^b, v_{i,1}^1, v_i^a, v_{k,1}^1\} \sqcup \{v_m^1 \mid m \in \{1, \dots, d\} \setminus \{i, j, k\}\}$$

is an  $f$ -weighted 3-path vertex cover of  $(\Sigma_3 G)_\lambda$ , and

$$v_{j,2}v_{j,1}v_jv_k \in \mathfrak{P}_{j,2}, \quad v_{j,1}v_jv_iv_k \in \mathfrak{P}_{j,0}, \quad v_{i,1}v_iv_jv_k \in \mathfrak{P}_{i,1},$$

$$v_iv_kv_jv_{j,1} \in \mathfrak{P}_{i,0}, \quad v_{j,1}v_jv_kv_{k,1} \in \mathfrak{P}_{k,1}, \quad v_{t,3}v_{t,2}v_{t,1}v_t \in \mathfrak{P}_{t,0}$$

for any  $t \in \{1, \dots, d\} \setminus \{i, j, k\}$ .

(2) Assume that  $l_1 \neq j$ , then  $l_2 = 0$ .

(i) Assume that  $f(\lambda(v_j v_{j,1}), \lambda(v_j v_k)) < b$ .

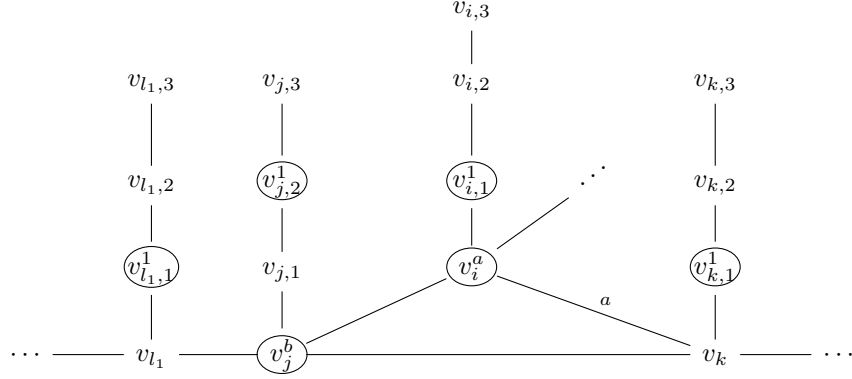

Then it is straightforward to show that

$$\mathfrak{P} := (V'', \delta'') := \{v_{l_1,1}^1, v_{j,2}^1, v_j^b, v_{i,1}^1, v_i^a, v_{k,1}^1\} \sqcup \{v_m^1 \mid m \in \{1, \dots, d\} \setminus \{i, j, k, l_1\}\}$$

is an  $f$ -weighted 3-path vertex cover of  $(\Sigma_3 G)_\lambda$ , and

$$\begin{aligned} v_{l_1,3} v_{l_1,2} v_{l_1,1} v_{l_1} &\in \mathfrak{P}_{l_1,1}, \quad v_{j,2} v_{j,1} v_j v_k \in \mathfrak{P}_{j,2}, \quad v_{l_1} v_j v_i v_k \in \mathfrak{P}_{j,0}, \quad v_{i,1} v_i v_j v_k \in \mathfrak{P}_{i,1}, \\ v_i v_k v_j v_{l_1} &\in \mathfrak{P}_{i,0}, \quad v_{l_1} v_j v_k v_{k,1} \in \mathfrak{P}_{k,1}, \quad v_{t,3} v_{t,2} v_{t,1} v_t \in \mathfrak{P}_{t,0} \end{aligned}$$

for any  $t \in \{1, \dots, d\} \setminus \{i, j, k, l_1\}$ .

(ii) Assume that  $f(\lambda(v_j v_{j,1}), \lambda(v_j v_k)) \geq b$ .

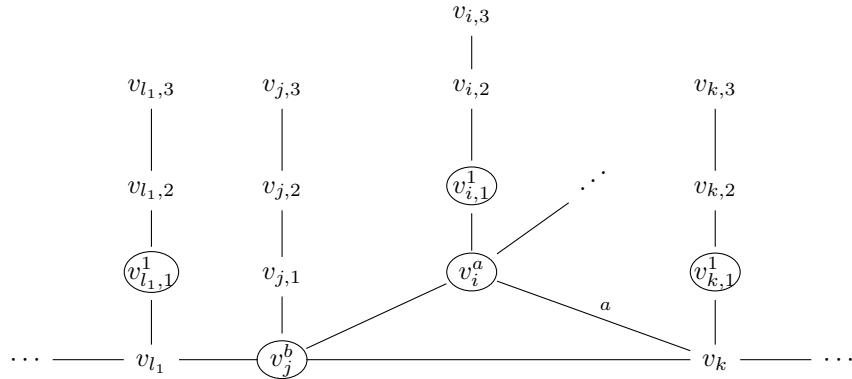



Then it is straightforward to show that

$$\mathfrak{P} := (V'', \delta'') := \{v_{l_1,1}^1, v_j^b, v_{i,1}^1, v_i^a, v_{k,1}^1\} \sqcup \{v_m^1 \mid m \in \{1, \dots, d\} \setminus \{i, j, k, l_1\}\}$$

is an  $f$ -weighted 3-path vertex cover of  $(\Sigma_3 G)_\lambda$ , and

$$v_{l_1,3}v_{l_1,2}v_{l_1,1}v_{l_1} \in \mathfrak{P}_{l_1,1}, \quad v_{l_1}v_jv_iv_k \in \mathfrak{P}_{j,0}, \quad v_{i,1}v_iv_jv_k \in \mathfrak{P}_{i,1},$$

$$v_iv_kv_jv_{l_1} \in \mathfrak{P}_{i,0}, \quad v_{l_1}v_jv_kv_{k,1} \in \mathfrak{P}_{k,0}, \quad v_{t,3}v_{t,2}v_{t,1}v_t \in \mathfrak{P}_{t,0}$$

for any  $t \in \{1, \dots, d\} \setminus \{i, j, k, l_1\}$ .

(j) Let  $v_iv_jv_k$  be a 3-cycle in  $G$  such that  $f(\lambda(v_iv_{i,1}), \lambda(v_iv_j)) < \lambda(v_iv_k) =: a$  and there exists  $v_kv_{l_1,l_2} \in E((\Sigma_3 G)_\lambda)$  with  $v_i \neq v_{l_1,l_2} \neq v_j$ . Suppose that

$$b := f(\lambda(v_kv_j), \lambda(v_kv_{l_1,l_2})) > \max\{\lambda(v_kv_j), f(\lambda(v_kv_i), \lambda(v_kv_{l_1,l_2}))\}$$

and  $f(\lambda(v_jv_i), \lambda(v_jv_k)) < \lambda(v_jv_i) =: c$ .

(1) Assume that  $l_1 = k$ , then  $l_2 = 1$ .

(i) Assume that  $f(\lambda(v_{j,1}v_j), \lambda(v_jv_k)) < c$ .

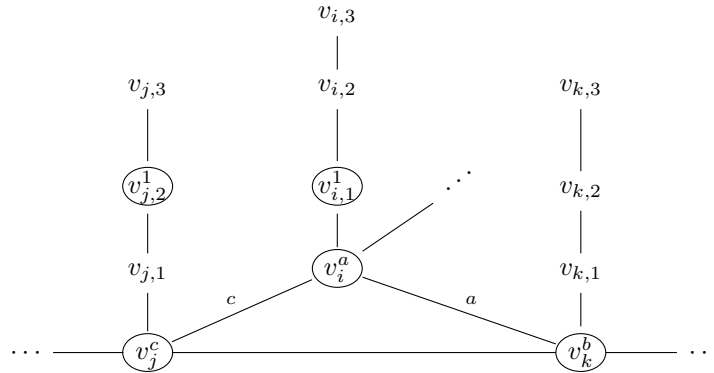

Then it is straightforward to show that

$$\mathfrak{P} := (V'', \delta'') := \{v_{j,2}^1, v_j^c, v_{i,1}^1, v_i^a, v_k^b\} \sqcup \{v_m^1 \mid m \in \{1, \dots, d\} \setminus \{i, j, k\}\}$$

is an  $f$ -weighted 3-path vertex cover of  $(\Sigma_3 G)_\lambda$ , and for any  $t \in \{1, \dots, d\} \setminus \{i, j, k\}$ ,

$$\begin{aligned} v_{j,2}v_{j,1}v_jv_k &\in \mathfrak{P}_{j,2}, \quad v_jv_iv_kv_{k,1} \in \mathfrak{P}_{j,0}, \quad v_{i,1}v_iv_jv_k \in \mathfrak{P}_{i,1}, \\ v_iv_kv_{k,1}v_{k,2} &\in \mathfrak{P}_{i,0}, \quad v_iv_jv_kv_{k,1} \in \mathfrak{P}_{k,0}, \quad v_{t,3}v_{t,2}v_{t,1}v_t \in \mathfrak{P}_{t,0}. \end{aligned}$$

(ii) Assume that  $f(\lambda(v_{j,1}v_j), \lambda(v_jv_k)) \geq c$ .

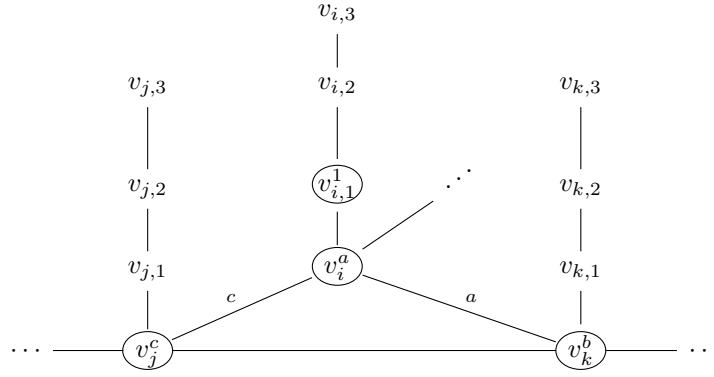

Then it is straightforward to show that

$$\mathfrak{P} := (V'', \delta'') := \{v_j^c, v_{i,1}^1, v_i^a, v_k^b\} \sqcup \{v_m^1 \mid m \in \{1, \dots, d\} \setminus \{i, j, k\}\}$$

is an  $f$ -weighted 3-path vertex cover of  $(\Sigma_3 G)_\lambda$ , such that one has  $v_jv_iv_kv_{k,1} \in \mathfrak{P}_{j,0}$ ,  $v_{i,1}v_iv_jv_k \in \mathfrak{P}_{i,1}$ ,  $v_iv_kv_{k,1}v_{k,2} \in \mathfrak{P}_{i,0}$ ,  $v_iv_jv_kv_{k,1} \in \mathfrak{P}_{k,0}$ ,  $v_{t,3}v_{t,2}v_{t,1}v_t \in \mathfrak{P}_{t,0}$  for any  $t \in \{1, \dots, d\} \setminus \{i, j, k\}$ .

(2) Assume that  $l_1 \neq k$ , then  $l_2 = 0$ .

(i) Assume that  $f(\lambda(v_{j,1}v_j), \lambda(v_jv_k)) < c$ .

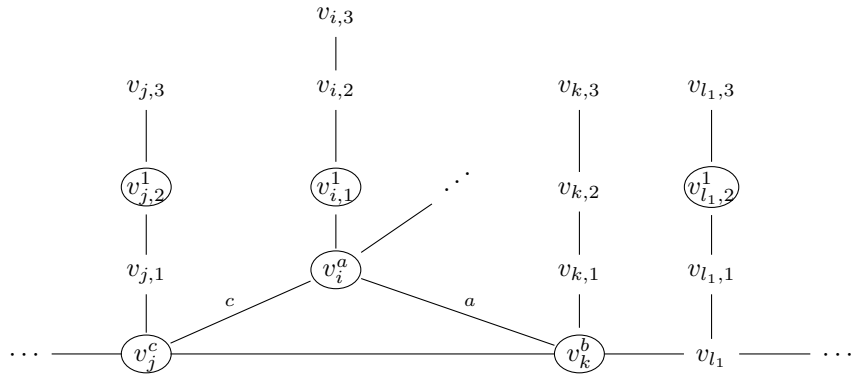

Then it is straightforward to show that

$$\mathfrak{P} := (V'', \delta'') := \{v_{j,2}^1, v_j^c, v_{i,1}^1, v_i^a, v_k^b, v_{l_1,2}^1\} \sqcup \{v_m^1 \mid m \in \{1, \dots, d\} \setminus \{i, j, k, l_1\}\}$$

is an  $f$ -weighted 3-path vertex cover of  $(\Sigma_3 G)_\lambda$ , and

$$v_{j,2}v_{j,1}v_jv_k \in \mathfrak{P}_{j,2}, \quad v_jv_iv_kv_{l_1} \in \mathfrak{P}_{j,0}, \quad v_{i,1}v_iv_jv_k \in \mathfrak{P}_{i,1}, \quad v_iv_kv_{l_1,0}v_{l_1,1} \in \mathfrak{P}_{i,0},$$

$$v_iv_jv_kv_{l_1} \in \mathfrak{P}_{k,0}, \quad v_{l_1,3}v_{l_1,2}v_{l_1,1}v_{l_1} \in \mathfrak{P}_{l_1,2}, \quad v_{t,3}v_{t,2}v_{t,1}v_t \in \mathfrak{P}_{t,0}$$

for any  $t \in \{1, \dots, d\} \setminus \{i, j, k, l_1\}$ .

(ii) Assume that  $f(\lambda(v_{j,1}v_j), \lambda(v_jv_k)) \geq c$ .

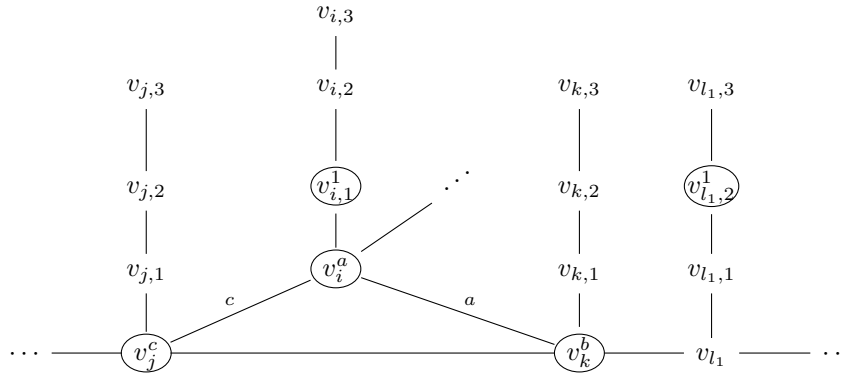

Then it is straightforward to show that

$$\mathfrak{P} := (V'', \delta'') := \{v_j^c, v_{i,1}^1, v_i^a, v_k^b, v_{l_1,2}^1\} \sqcup \{v_m^1 \mid m \in \{1, \dots, d\} \setminus \{i, j, k, l_1\}\}$$

is an  $f$ -weighted 3-path vertex cover of  $(\Sigma_3 G)_\lambda$ , and

$$v_jv_iv_kv_{l_1} \in \mathfrak{P}_{j,0}, \quad v_{i,1}v_iv_jv_k \in \mathfrak{P}_{i,1}, \quad v_iv_kv_{l_1,0}v_{l_1,1} \in \mathfrak{P}_{i,0},$$

$$v_iv_jv_kv_{l_1} \in \mathfrak{P}_{k,0}, \quad v_{l_1,3}v_{l_1,2}v_{l_1,1}v_{l_1} \in \mathfrak{P}_{l_1,2}, \quad v_{t,3}v_{t,2}v_{t,1}v_t \in \mathfrak{P}_{t,0}$$

for any  $t \in \{1, \dots, d\} \setminus \{i, j, k, l_1\}$ .

(k) Let  $v_iv_jv_kv_{l_1}$  be a 4-cycle such that  $f(\lambda(v_{i,1}v_i), \lambda(v_iv_j)) < \lambda(v_iv_{l_1}) =: a$ . Suppose that we have

$f(\lambda(v_k v_j), \lambda(v_k v_l)) < \lambda(v_k v_l) =: b$  and  $f(\lambda(v_l v_i), \lambda(v_l v_k)) < \min\{\lambda(v_l v_i), \lambda(v_l v_k)\} =: c$ .

(1) Assume that  $f(\lambda(v_{k,1} v_k), \lambda(v_k v_j)) < b$ .

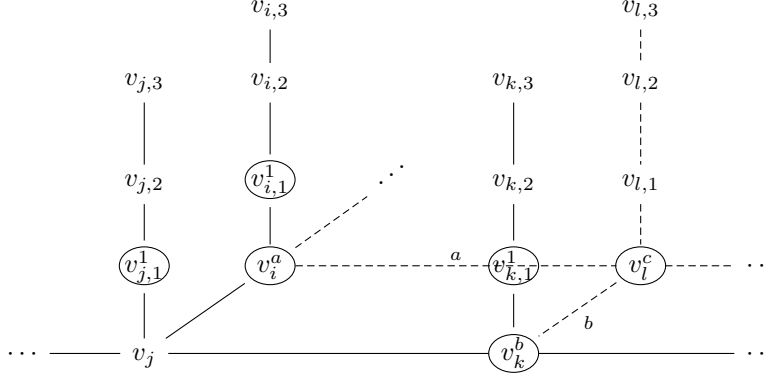

Then it is straightforward to show that

$$\mathfrak{P} := (V'', \delta'') := \{v_{i,1}^1, v_i^a, v_{j,1}^1, v_{k,1}^1, v_k^b, v_l^c\} \sqcup \{v_m^1 \mid m \in \{1, \dots, d\} \setminus \{i, j, k, l\}\}$$

is an  $f$ -weighted 3-path vertex cover of  $(\Sigma_3 G)_\lambda$ , and

$$v_{i,1} v_i v_j v_k \in \mathfrak{P}_{i,1}, v_i v_l v_k v_j \in \mathfrak{P}_{i,0}, v_{j,3} v_{j,2} v_{j,1} v_j \in \mathfrak{P}_{j,1}, v_i v_j v_k v_{k,1} \in \mathfrak{P}_{k,1},$$

$$v_j v_i v_l v_k \in \mathfrak{P}_{k,0}, v_i v_j v_k v_l \in \mathfrak{P}_{l,0}, v_{t,3} v_{t,2} v_{t,1} v_t \in \mathfrak{P}_{t,0}$$

for any  $t \in \{1, \dots, d\} \setminus \{i, j, k, l\}$ .

(2) Assume that  $f(\lambda(v_{k,1} v_k), \lambda(v_k v_j)) \geq b$ .

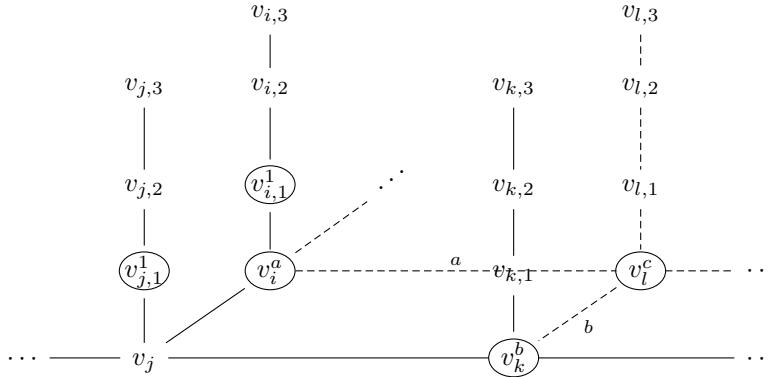

Then it is straightforward to show that

$$\mathfrak{P} := (V'', \delta'') := \{v_{i,1}^1, v_i^a, v_{j,1}^1, v_k^b, v_l^c\} \sqcup \{v_m^1 \mid m \in \{1, \dots, d\} \setminus \{i, j, k, l\}\}$$

is an  $f$ -weighted 3-path vertex cover of  $(\Sigma_3 G)_\lambda$ , and

$$\begin{aligned} v_{i,1}v_iv_jv_k &\in \mathfrak{P}_{i,1}, \quad v_iv_lv_kv_j \in \mathfrak{P}_{i,0}, \quad v_{j,3}v_{j,2}v_{j,1}v_j \in \mathfrak{P}_{j,1}, \\ v_jv_iv_lv_k &\in \mathfrak{P}_{k,0}, \quad v_iv_jv_kv_l \in \mathfrak{P}_{l,0}, \quad v_{t,3}v_{t,2}v_{t,1}v_t \in \mathfrak{P}_{t,0} \end{aligned}$$

for any  $t \in \{1, \dots, d\} \setminus \{i, j, k, l\}$ .

(l) Let  $v_iv_jv_kv_l$  be a 4-cycle such that  $f(\lambda(v_{i,1}v_i), \lambda(v_iv_j)) < \lambda(v_iv_l) =: a$ . Suppose that we have  $f(\lambda(v_kv_j), \lambda(v_kv_l)) < \lambda(v_kv_l) =: b$  and  $c := f(\lambda(v_jv_i), \lambda(v_jv_k)) > \max\{\lambda(v_jv_i), \lambda(v_jv_k)\}$ .

(1) Assume that  $f(\lambda(v_{k,1}v_k), \lambda(v_kv_j)) < b$ .

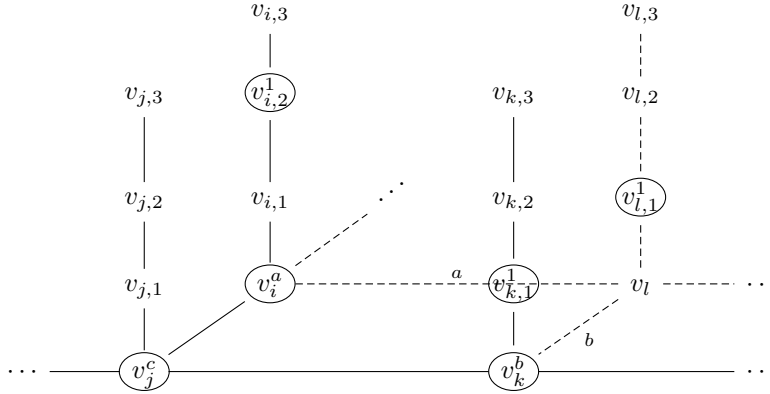

Then it is straightforward to show that

$$\mathfrak{P} := (V'', \delta'') := \{v_{i,2}^1, v_i^a, v_j^c, v_{k,1}^1, v_k^b, v_{l,1}^1\} \sqcup \{v_m^1 \mid m \in \{1, \dots, d\} \setminus \{i, j, k, l\}\}$$

is an  $f$ -weighted 3-path vertex cover of  $(\Sigma_3 G)_\lambda$ , and for any  $t \in \{1, \dots, d\} \setminus \{i, j, k, l\}$ ,

$$\begin{aligned} v_{i,2}v_{i,1}v_iv_j &\in \mathfrak{P}_{i,2}, \quad v_iv_lv_kv_j \in \mathfrak{P}_{i,0}, \quad v_iv_jv_kv_l \in \mathfrak{P}_{j,0}, \quad v_{k,2}v_{k,1}v_kv_j \in \mathfrak{P}_{k,1}, \\ v_jv_iv_lv_k &\in \mathfrak{P}_{k,0}, \quad v_{l,3}v_{l,2}v_{l,1}v_l \in \mathfrak{P}_{l,1}, \quad v_{t,3}v_{t,2}v_{t,1}v_t \in \mathfrak{P}_{t,0}. \end{aligned}$$

(2) Assume that  $f(\lambda(v_{k,1}v_k), \lambda(v_kv_j)) \geq b$ .

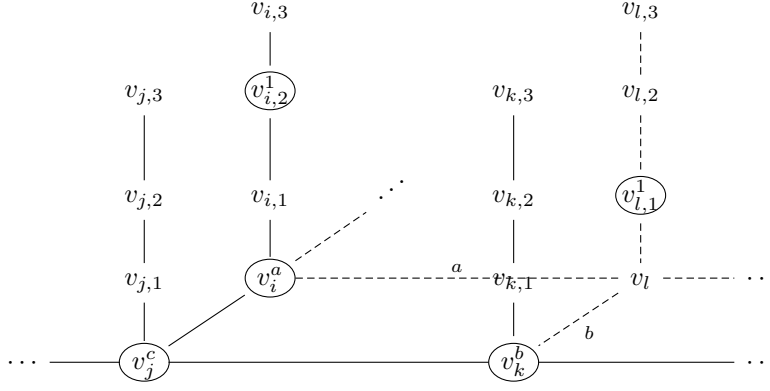

Then it is straightforward to show that

$$\mathfrak{P} := (V'', \delta'') := \{v_{i,2}^1, v_i^a, v_j^c, v_k^b, v_{l,1}^1\} \sqcup \{v_m^1 \mid m \in \{1, \dots, d\} \setminus \{i, j, k, l\}\}$$

is an  $f$ -weighted 3-path vertex cover of  $(\Sigma_3 G)_\lambda$ , and

$$\begin{aligned} v_{i,2}v_{i,1}v_iv_j &\in \mathfrak{P}_{i,2}, \quad v_iv_kv_kv_j \in \mathfrak{P}_{i,0}, \quad v_iv_jv_kv_l \in \mathfrak{P}_{j,0}, \\ v_jv_iv_kv_k &\in \mathfrak{P}_{k,0}, \quad v_{l,3}v_{l,2}v_{l,1}v_l \in \mathfrak{P}_{l,1}, \quad v_{t,3}v_{t,2}v_{t,1}v_t \in \mathfrak{P}_{t,0} \end{aligned}$$

for any  $t \in \{1, \dots, d\} \setminus \{i, j, k, l\}$ .

(m) Let  $v_iv_kv_kv_l$  be a 4-cycle such that  $f(\lambda(v_{i,1}v_i), \lambda(v_iv_j)) < \lambda(v_iv_l) =: a$ . Suppose that we have  $f(\lambda(v_kv_j), \lambda(v_kv_l)) < \lambda(v_kv_k) =: b$ ,  $f(\lambda(v_lv_i), \lambda(v_lv_k)) < \lambda(v_lv_k) = b$ , and  $f(\lambda(v_kv_j), \lambda(v_kv_l)) < \lambda(v_kv_j) =: c$ . Let  $x := \min\{b, c\}$ .

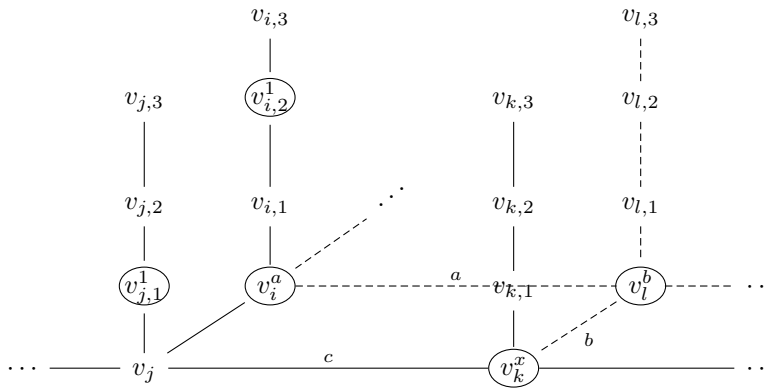

Then it is straightforward to show that

$$\mathfrak{P} := (V'', \delta'') := \{v_{i,2}^1, v_i^a, v_{j,1}, v_{k,1}^1, v_k^x, v_{l,1}^1\} \sqcup \{v_m^1 \mid m \in \{1, \dots, d\} \setminus \{i, j, k, l\}\}$$

is an  $f$ -weighted 3-path vertex cover of  $(\Sigma_3 G)_\lambda$ , and

$$v_{i,2}v_{i,1}v_i v_j \in \mathfrak{P}_{i,2}, \quad v_i v_l v_k v_j \in \mathfrak{P}_{i,0}, \quad v_{j,3}v_{j,2}v_{j,1}v_j \in \mathfrak{P}_{j,1},$$

$$v_j v_i v_l v_k \in \mathfrak{P}_{k,0}, \quad v_i v_j v_k v_l \in \mathfrak{P}_{l,0}, \quad v_{t,3}v_{t,2}v_{t,1}v_t \in \mathfrak{P}_{t,0}$$

for any  $t \in \{1, \dots, d\} \setminus \{i, j, k, l\}$ .

(n) Let  $v_i v_j v_k v_l$  be a 4-cycle such that  $f(\lambda(v_{i,1}v_i), \lambda(v_i v_j)) < \lambda(v_i v_l) =: a$ . Suppose that we have  $f(\lambda(v_k v_j), \lambda(v_k v_l)) < \lambda(v_k v_l) =: b$ ,  $f(\lambda(v_l v_i), \lambda(v_l v_k)) < \lambda(v_l v_k) = b$ , and  $f(\lambda(v_l v_i), \lambda(v_l v_k)) < \lambda(v_l v_i) = a$ . Let  $c := \min\{a, b\}$ .

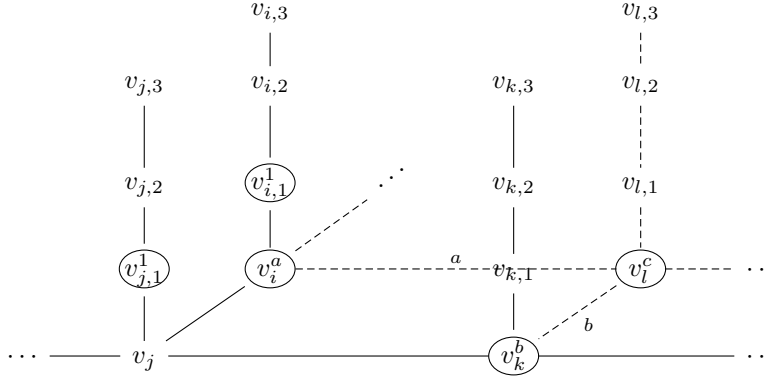

Then it is straightforward to show that

$$\mathfrak{P} := (V'', \delta'') := \{v_{i,1}^1, v_i^a, v_{j,1}, v_{k,1}^1, v_k^x, v_{l,1}^1\} \sqcup \{v_m^1 \mid m \in \{1, \dots, d\} \setminus \{i, j, k, l\}\}$$

is an  $f$ -weighted 3-path vertex cover of  $(\Sigma_3 G)_\lambda$ , and for any  $t \in \{1, \dots, d\} \setminus \{i, j, k, l\}$ ,

$$v_{i,2}v_{i,1}v_i v_j \in \mathfrak{P}_{i,1}, \quad v_i v_l v_k v_j \in \mathfrak{P}_{i,0}, \quad v_{j,3}v_{j,2}v_{j,1}v_j \in \mathfrak{P}_{j,1},$$

$$v_j v_i v_l v_k \in \mathfrak{P}_{k,0}, \quad v_i v_j v_k v_l \in \mathfrak{P}_{l,0}, \quad v_{t,3}v_{t,2}v_{t,1}v_t \in \mathfrak{P}_{t,0}.$$

(o) Let  $v_i v_j v_k v_l$  be a 4-cycle such that  $f(\lambda(v_{i,1}v_i), \lambda(v_i v_j)) < \lambda(v_i v_l) =: a$ . Suppose that we have

$f(\lambda(v_k v_j), \lambda(v_k v_l)) < \lambda(v_k v_l) =: b$ ,  $v_j v_l \in E(G)$ , and

$$c := f(\lambda(v_j v_i), \lambda(v_j v_k)) > \max\{\lambda(v_j v_k), f(\lambda(v_j v_i), \lambda(v_j v_l))\}.$$

(1) Assume that  $f(\lambda(v_{k,1} v_k), \lambda(v_k v_j)) < b$ .

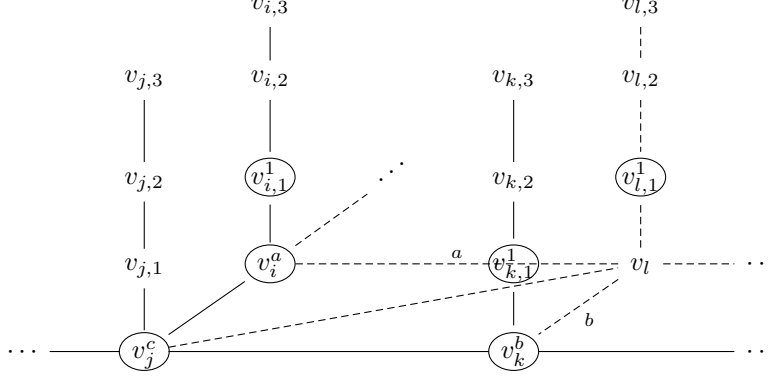

Then it is straightforward to show that

$$\mathfrak{P} := (V'', \delta'') := \{v_{i,1}^1, v_i^a, v_j^c, v_{k,1}^1, v_k^b, v_{l,1}^1\} \sqcup \{v_m^1 \mid m \in \{1, \dots, d\} \setminus \{i, j, k, l\}\}$$

is an  $f$ -weighted 3-path vertex cover of  $(\Sigma_3 G)_\lambda$ , and for any  $t \in \{1, \dots, d\} \setminus \{i, j, k, l\}$ ,

$$\begin{aligned} v_{i,1} v_i v_j v_l &\in \mathfrak{P}_{i,1}, \quad v_i v_l v_k v_j \in \mathfrak{P}_{i,0}, \quad v_i v_j v_k v_l \in \mathfrak{P}_{j,0}, \quad v_{k,2} v_{k,1} v_k v_j \in \mathfrak{P}_{k,1}, \\ v_i v_j v_l v_k &\in \mathfrak{P}_{k,0}, \quad v_{l,3} v_{l,2} v_{l,1} v_l \in \mathfrak{P}_{l,1}, \quad v_{t,3} v_{t,2} v_{t,1} v_t \in \mathfrak{P}_{t,0}. \end{aligned}$$

(2) Assume that  $f(\lambda(v_{k,1} v_k), \lambda(v_k v_j)) \geq b$ .

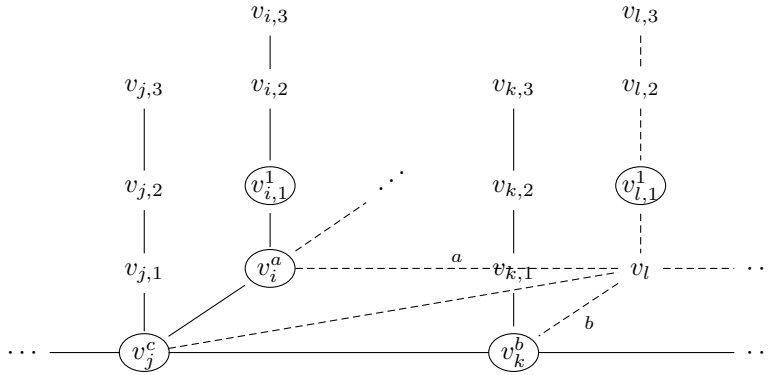



Then it is straightforward to show that

$$\mathfrak{P} := (V'', \delta'') := \{v_{i,1}^1, v_i^a, v_j^c, v_k^b, v_{l,1}^1\} \sqcup \{v_m^1 \mid m \in \{1, \dots, d\} \setminus \{i, j, k, l\}\}$$

is an  $f$ -weighted 3-path vertex cover of  $(\Sigma_3 G)_\lambda$ , and

$$\begin{aligned} v_{i,1}v_i v_j v_l &\in \mathfrak{P}_{i,1}, \quad v_i v_l v_k v_j \in \mathfrak{P}_{i,0}, \quad v_i v_j v_k v_l \in \mathfrak{P}_{j,0}, \\ v_j v_i v_l v_k &\in \mathfrak{P}_{k,0}, \quad v_{l,3} v_{l,2} v_{l,1} v_l \in \mathfrak{P}_{l,1}, \quad v_{t,3} v_{t,2} v_{t,1} v_t \in \mathfrak{P}_{t,0} \end{aligned}$$

for any  $t \in \{1, \dots, d\} \setminus \{i, j, k, l\}$ .

(p) Let  $v_i v_j v_k v_l$  be a 4-cycle such that  $f(\lambda(v_{i,1}v_i), \lambda(v_i v_j)) < \lambda(v_i v_l) =: a$ . Suppose that we have  $f(\lambda(v_k v_j), \lambda(v_k v_l)) < \lambda(v_k v_l)$ ,  $f(\lambda(v_j v_i), \lambda(v_j v_k)) < \lambda(v_j v_i) =: b$ ,  $f(\lambda(v_l v_i), \lambda(v_l v_k)) < \lambda(v_l v_i) = a$ ,  $f(\lambda(v_l v_i), \lambda(v_l v_k)) < \min\{\lambda(v_l v_i), \lambda(v_l v_k)\} =: c$ , and there exists  $v_k v_{l_1, l_2} \in E((\Sigma_r G)_\lambda)$  with  $v_j \neq v_{l_1, l_2} \neq v_l$  such that

$$\begin{aligned} x &:= f(\lambda(v_k v_j), \lambda(v_k v_l)) > \max\{\lambda(v_k v_j), f(\lambda(v_k v_l), \lambda(v_k v_{l_1, l_2}))\}, \\ y &:= f(\lambda(v_k v_j), \lambda(v_k v_{l_1, l_2})) > \max\{\lambda(v_k v_j), f(\lambda(v_k v_l), \lambda(v_k v_{l_1, l_2}))\}. \end{aligned}$$

Then  $l_1 \neq k$ , and so  $l_2 = 0$ .

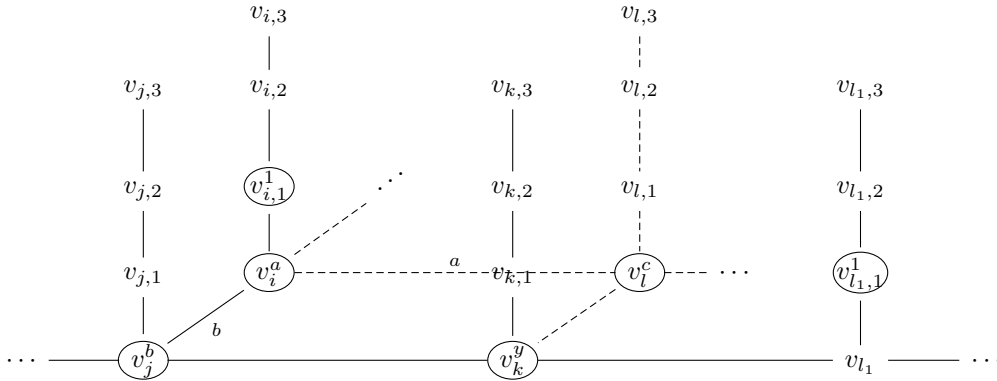

Then it is straightforward to show that

$$\mathfrak{P} := (V'', \delta'') := \{v_{i,1}^1, v_i^a, v_j^b, v_k^y, v_{l,1}^1, v_l^a\} \sqcup \{v_m^1 \mid m \in \{1, \dots, d\} \setminus \{i, j, k, l, l_1\}\}$$

is an  $f$ -weighted 3-path vertex cover of  $(\Sigma_3 G)_\lambda$ , and for any  $t \in \{1, \dots, d\} \setminus \{i, j, k, l, l_1\}$ ,

$$\begin{aligned} v_{i,1}v_iv_jv_kv_l &\in \mathfrak{P}_{i,1}, \quad v_iv_lv_kv_l \in \mathfrak{P}_{i,0}, \quad v_{j,3}v_{j,2}v_{j,1}v_j \in \mathfrak{P}_{j,0}, \quad v_iv_jv_kv_l \in \mathfrak{P}_{k,0}, \\ v_iv_iv_jv_kv_l &\in \mathfrak{P}_{l,0}, \quad v_{l_1,3}v_{l_1,2}v_{l_1,1}v_{l_1} \in \mathfrak{P}_{l_1,1}, \quad v_{t,3}v_{t,2}v_{t,1}v_t \in \mathfrak{P}_{t,0}. \end{aligned}$$

(q) Let  $v_iv_jv_kv_l$  be a 4-cycle such that  $f(\lambda(v_{i,1}v_i), \lambda(v_iv_j)) < \lambda(v_iv_l) =: a$ . Suppose that we have  $f(\lambda(v_kv_j), \lambda(v_kv_l)) < \lambda(v_kv_l)$ ,  $f(\lambda(v_jv_i), \lambda(v_jv_k)) < \lambda(v_jv_i) =: b$ ,  $f(\lambda(v_lv_i), \lambda(v_lv_k)) < \lambda(v_lv_i) = a$ ,  $f(\lambda(v_kv_j), \lambda(v_kv_l)) > \lambda(v_kv_l)$ , and there exists  $v_kv_{l_1, l_2} \in E((\Sigma_r G)_\lambda)$  with  $v_j \neq v_{l_1, l_2} \neq v_l$  such that

$$\begin{aligned} x &:= f(\lambda(v_kv_j), \lambda(v_kv_l)) > \max\{\lambda(v_kv_j), f(\lambda(v_kv_l), \lambda(v_kv_{l_1, l_2}))\}, \\ y &:= f(\lambda(v_kv_j), \lambda(v_kv_{l_1, l_2})) > \max\{\lambda(v_kv_j), f(\lambda(v_kv_l), \lambda(v_kv_{l_1, l_2}))\}. \end{aligned}$$

Then we have that  $f(\lambda(v_kv_j), \lambda(v_kv_l)) < \lambda(v_kv_l) < f(\lambda(v_kv_j), \lambda(v_kv_l))$ , a contradiction.

(r) Let  $v_iv_jv_kv_l$  be a 4-cycle such that  $f(\lambda(v_{i,1}v_i), \lambda(v_iv_j)) < \lambda(v_iv_l) =: a$ . Suppose that we have  $f(\lambda(v_kv_j), \lambda(v_kv_l)) < \lambda(v_kv_l) =: b$ ,  $f(\lambda(v_lv_i), \lambda(v_lv_k)) < \lambda(v_lv_i) = a$ , and we have that there exists  $v_jv_{l_1, l_2} \in E((\Sigma_r G)_\lambda)$  with  $v_i \neq v_{l_1, l_2} \neq v_k$  such that

$$\begin{aligned} c &:= f(\lambda(v_jv_i), \lambda(v_jv_k)) > \max\{\lambda(v_jv_k), f(\lambda(v_jv_i), \lambda(v_jv_{l_1, l_2}))\}, \\ x &:= f(\lambda(v_jv_k), \lambda(v_jv_{l_1, l_2})) > \max\{\lambda(v_jv_k), f(\lambda(v_jv_i), \lambda(v_jv_{l_1, l_2}))\}. \end{aligned}$$

Then  $l_1 \neq k$ , and so  $l_2 = 0$ . Let  $y := \min\{x, c\}$ .

(1) Assume that  $f(\lambda(v_{k,1}v_k), \lambda(v_kv_j)) < b$ .

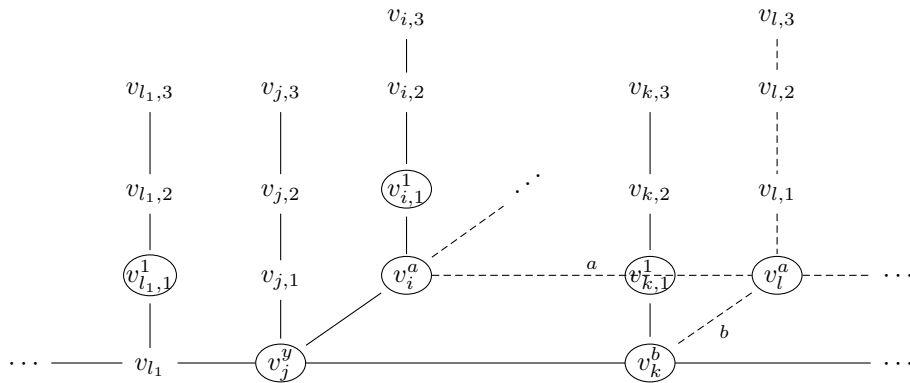

Then it is straightforward to show that

$$\mathfrak{P} := (V'', \delta'') := \{v_{i,1}^1, v_i^a, v_j^y, v_{k,1}^1, v_k^b, v_l^a, v_{l,1}^1\} \sqcup \{v_m^1 \mid m \in \{1, \dots, d\} \setminus \{i, j, k, l, l_1\}\}$$

is an  $f$ -weighted 3-path vertex cover of  $(\Sigma_3 G)_\lambda$ , and

$$v_{i,1}v_iv_jv_{l_1} \in \mathfrak{P}_{i,1}, \quad v_iv_lv_kv_j \in \mathfrak{P}_{i,0}, \quad v_iv_jv_kv_l \in \mathfrak{P}_{j,0}, \quad v_{k,2}v_{k,1}v_kv_j \in \mathfrak{P}_{k,1},$$

$$v_jv_iv_lv_k \in \mathfrak{P}_{k,0}, \quad v_lv_iv_jv_{l_1} \in \mathfrak{P}_{l,0}, \quad v_{l_1,3}v_{l_1,2}v_{l_1,1}v_{l_1} \in \mathfrak{P}_{l_1,1}, \quad v_{t,3}v_{t,2}v_{t,1}v_t \in \mathfrak{P}_{t,0}$$

for any  $t \in \{1, \dots, d\} \setminus \{i, j, k, l\}$ .

(2) Assume that  $f(\lambda(v_{k,1}v_k), \lambda(v_kv_j)) \geq b$ .

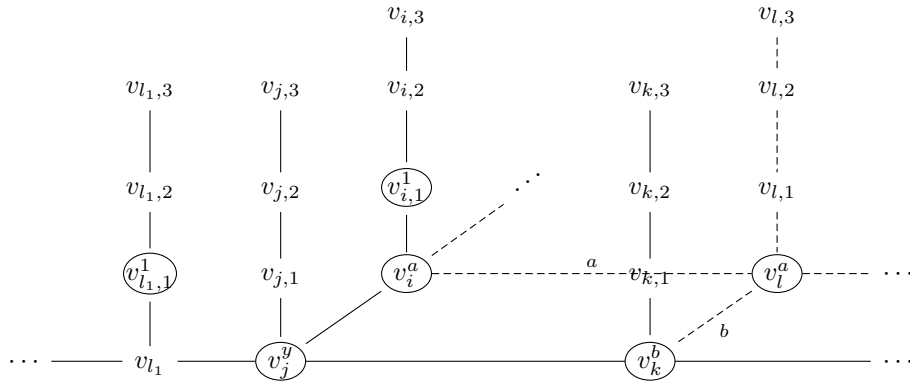

Then it is straightforward to show that

$$\mathfrak{P} := (V'', \delta'') := \{v_{i,1}^1, v_i^a, v_j^y, v_k^b, v_l^a, v_{l,1}^1\} \sqcup \{v_m^1 \mid m \in \{1, \dots, d\} \setminus \{i, j, k, l, l_1\}\}$$

is an  $f$ -weighted 3-path vertex cover, and

$$v_{i,1}v_iv_jv_{l_1} \in \mathfrak{P}_{i,1}, \quad v_iv_lv_kv_j \in \mathfrak{P}_{i,0}, \quad v_iv_jv_kv_l \in \mathfrak{P}_{j,0}, \quad v_jv_iv_lv_k \in \mathfrak{P}_{k,0},$$

$$v_lv_iv_jv_{l_1} \in \mathfrak{P}_{l,0}, \quad v_{l_1,3}v_{l_1,2}v_{l_1,1}v_{l_1} \in \mathfrak{P}_{l_1,1}, \quad v_{t,3}v_{t,2}v_{t,1}v_t \in \mathfrak{P}_{t,0}$$

for any  $t \in \{1, \dots, d\} \setminus \{i, j, k, l\}$ .

(s) Let  $v_iv_jv_kv_l$  be a 4-cycle such that  $f(\lambda(v_{i,1}v_i), \lambda(v_iv_j)) < \lambda(v_iv_l) =: a$ . Suppose that we have

$f(\lambda(v_j v_i), \lambda(v_j v_k)) < \lambda(v_j v_i) =: b$  and  $f(\lambda(v_l v_i), \lambda(v_l v_k)) < \min\{\lambda(v_l v_i), \lambda(v_l v_k)\} =: c$ .

(1) Assume that  $f(\lambda(v_{j,1} v_j), \lambda(v_j v_k)) < b$ .

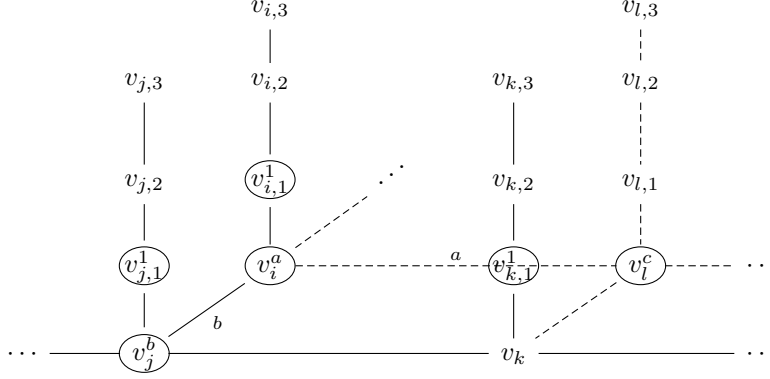

Then it is straightforward to show that

$$\mathfrak{P} := (V'', \delta'') := \{v_{i,1}^1, v_i^a, v_{j,1}^1, v_j^b, v_{k,1}^1, v_k^b, v_l^c\} \sqcup \{v_m^1 \mid m \in \{1, \dots, d\} \setminus \{i, j, k, l\}\}$$

is an  $f$ -weighted 3-path vertex cover of  $(\Sigma_3 G)_\lambda$ , and

$$v_{i,1} v_i v_j v_k \in \mathfrak{P}_{i,1}, \quad v_i v_l v_k v_j \in \mathfrak{P}_{i,0}, \quad v_{j,2} v_{j,1} v_j v_k \in \mathfrak{P}_{j,1}, \quad v_j v_i v_l v_k \in \mathfrak{P}_{j,0},$$

$$v_{k,3} v_{k,2} v_{k,1} v_k \in \mathfrak{P}_{k,1}, \quad v_i v_j v_k v_l \in \mathfrak{P}_{l,0}, \quad v_{t,3} v_{t,2} v_{t,1} v_t \in \mathfrak{P}_{t,0}$$

for any  $t \in \{1, \dots, d\} \setminus \{i, j, k, l\}$ .

(2) Assume that  $f(\lambda(v_{j,1} v_j), \lambda(v_j v_k)) \geq b$ .

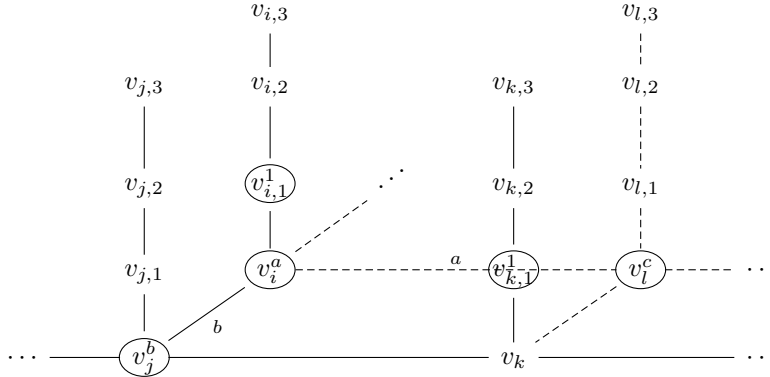

Then it is straightforward to show that

$$\mathfrak{P} := (V'', \delta'') := \{v_{i,1}^1, v_i^a, v_j^b, v_{k,1}^1, v_k^b, v_l^c\} \sqcup \{v_m^1 \mid m \in \{1, \dots, d\} \setminus \{i, j, k, l\}\}$$

is an  $f$ -weighted 3-path vertex cover of  $(\Sigma_3 G)_\lambda$ ,

$$v_{i,1}v_jv_kv_l \in \mathfrak{P}_{i,1}, \quad v_iv_lv_kv_j \in \mathfrak{P}_{i,0}, \quad v_jv_iv_lv_k \in \mathfrak{P}_{j,0},$$

$$v_{k,3}v_{k,2}v_{k,1}v_k \in \mathfrak{P}_{k,1}, \quad v_iv_jv_kv_l \in \mathfrak{P}_{l,0}, \quad v_tv_3v_{t,2}v_{t,1}v_t \in \mathfrak{P}_{t,0}$$

for any  $t \in \{1, \dots, d\} \setminus \{i, j, k, l\}$ .

(t) Let  $v_iv_jv_kv_l$  be a 4-cycle such that  $f(\lambda(v_{i,1}v_i), \lambda(v_iv_j)) < \lambda(v_iv_l) =: a$ . Suppose that we have  $f(\lambda(v_jv_i), \lambda(v_jv_k)) < \lambda(v_jv_i) =: b$  and  $f(\lambda(v_jv_i), \lambda(v_jv_k)) > \max\{\lambda(v_jv_i), \lambda(v_jv_k)\} \geq b$ , a contradiction.

(u) Let  $v_iv_jv_kv_l$  be a 4-cycle such that  $f(\lambda(v_{i,1}v_i), \lambda(v_iv_j)) < \lambda(v_iv_l) =: a$ . Suppose that we have  $f(\lambda(v_jv_i), \lambda(v_jv_k)) < \lambda(v_jv_i)$ ,  $f(\lambda(v_kv_j), \lambda(v_kv_l)) < \lambda(v_kv_l) =: b$ ,  $f(\lambda(v_lv_i), \lambda(v_lv_k)) < \lambda(v_lv_k) = b$ , and  $f(\lambda(v_kv_j), \lambda(v_kv_l)) < \lambda(v_kv_j) =: c$ . Then this case is similar to Case (m).

(v) Let  $v_iv_jv_kv_l$  be a 4-cycle such that  $f(\lambda(v_{i,1}v_i), \lambda(v_iv_j)) < \lambda(v_iv_l) =: a$ . Suppose that we have  $f(\lambda(v_jv_i), \lambda(v_jv_k)) < \lambda(v_jv_i)$ ,  $f(\lambda(v_kv_j), \lambda(v_kv_l)) < \lambda(v_kv_l) =: b$ ,  $f(\lambda(v_lv_i), \lambda(v_lv_k)) < \lambda(v_lv_k) = b$ , and  $f(\lambda(v_lv_i), \lambda(v_lv_k)) < \lambda(v_lv_i) = a$ . Then this case is similar to Case (n).

(w) Let  $v_iv_jv_kv_l$  be a 4-cycle such that  $f(\lambda(v_{i,1}v_i), \lambda(v_iv_j)) < \lambda(v_iv_l) =: a$ . Suppose that we have  $f(\lambda(v_jv_i), \lambda(v_jv_k)) < \lambda(v_jv_i)$ ,  $f(\lambda(v_kv_j), \lambda(v_kv_l)) < \lambda(v_kv_l) =: b$ ,  $v_jv_l \in E(G)$ , and

$$c := f(\lambda(v_jv_i), \lambda(v_jv_k)) > \max\{\lambda(v_jv_k), f(\lambda(v_jv_i), \lambda(v_jv_l))\}.$$

Then this case is similar to Case (o).

(x) Let  $v_iv_jv_kv_l$  be a 4-cycle such that  $f(\lambda(v_{i,1}v_i), \lambda(v_iv_j)) < \lambda(v_iv_l) =: a$ . Suppose that we have  $f(\lambda(v_jv_i), \lambda(v_jv_k)) < \lambda(v_jv_i) =: b$ ,  $f(\lambda(v_lv_i), \lambda(v_lv_k)) < \lambda(v_lv_i) =: c$ ,  $f(\lambda(v_lv_i), \lambda(v_lv_k)) < \min\{\lambda(v_lv_i), \lambda(v_lv_k)\}$ , and there exists  $v_kv_{l_1, l_2} \in E((\Sigma_r G)_\lambda)$  with  $v_j \neq v_{l_1, l_2} \neq v_l$  such that

$$x := f(\lambda(v_kv_j), \lambda(v_kv_l)) > \max\{\lambda(v_kv_j), f(\lambda(v_kv_l), \lambda(v_kv_{l_1, l_2}))\},$$

$$y := f(\lambda(v_k v_j), \lambda(v_k v_{l_1, l_2})) > \max\{\lambda(v_k v_j), f(\lambda(v_k v_l), \lambda(v_k v_{l_1, l_2}))\}.$$

Then this case is similar to Case (p).

(y) Let  $v_i v_j v_k v_l$  be a 4-cycle such that  $f(\lambda(v_{i,1} v_i), \lambda(v_i v_j)) < \lambda(v_i v_l) =: a$ . Suppose that we have  $f(\lambda(v_j v_i), \lambda(v_j v_k)) < \lambda(v_j v_i) =: b$ ,  $f(\lambda(v_l v_i), \lambda(v_l v_k)) < \lambda(v_l v_i) =: c$ ,  $f(\lambda(v_k v_j), \lambda(v_k v_l)) > \lambda(v_k v_l)$ , and there exists  $v_k v_{l_1, l_2} \in E((\Sigma_r G)_\lambda)$  with  $v_j \neq v_{l_1, l_2} \neq v_l$  such that

$$\begin{aligned} x &:= f(\lambda(v_k v_j), \lambda(v_k v_l)) > \max\{\lambda(v_k v_j), f(\lambda(v_k v_l), \lambda(v_k v_{l_1, l_2}))\}, \\ y &:= f(\lambda(v_k v_j), \lambda(v_k v_{l_1, l_2})) > \max\{\lambda(v_k v_j), f(\lambda(v_k v_l), \lambda(v_k v_{l_1, l_2}))\}. \end{aligned}$$

Then this case is also similar to Case (p).

(z) Let  $v_i v_j v_k v_l$  be a 4-cycle such that  $f(\lambda(v_{i,1} v_i), \lambda(v_i v_j)) < \lambda(v_i v_l) =: a$ . Suppose that we have  $f(\lambda(v_j v_i), \lambda(v_j v_k)) < \lambda(v_j v_i)$ ,  $f(\lambda(v_k v_j), \lambda(v_k v_l)) < \lambda(v_k v_l) =: b$ ,  $f(\lambda(v_l v_i), \lambda(v_l v_k)) < \lambda(v_l v_i) = a$ , and there exists  $v_j v_{l_1, l_2} \in E((\Sigma_r G)_\lambda)$  with  $v_i \neq v_{l_1, l_2} \neq v_k$  such that

$$\begin{aligned} c &:= f(\lambda(v_j v_i), \lambda(v_j v_k)) > \max\{\lambda(v_j v_k), f(\lambda(v_j v_i), \lambda(v_j v_{l_1, l_2}))\}, \\ x &:= f(\lambda(v_j v_k), \lambda(v_j v_{l_1, l_2})) > \max\{\lambda(v_j v_k), f(\lambda(v_j v_i), \lambda(v_j v_{l_1, l_2}))\}. \end{aligned}$$

Then this case is similar to Case (r). □

We discuss the necessary conditions for  $I_{r,f}((\Sigma_r G)_\lambda)$  to be unmixed when  $r \geq 4$ .

**Theorem 3.3.4.** *Assume that  $r \geq 4$ . Let  $(\Sigma_r G)_\lambda$  be a weighted  $r$ -path suspension of  $G_\omega$ . If  $I_{r,f}((\Sigma_r G)_\lambda)$  is unmixed, then the weight function  $\lambda$  satisfies the constraints in Proposition 3.2.44.*

*Proof.* By Lemma 3.3.1 and its proof, it is enough to show that if  $a := f(\lambda(v_{i,1} v_i), \lambda(v_i v_j)) > f(\lambda(v_{i,1} v_i), \lambda(v_i v_k)) =: b$  for a 2-path  $v_j v_i v_k$  in  $G_\omega$ , then there exists an  $f$ -weighted  $r$ -path vertex cover  $\mathfrak{P} := (V'', \delta'')$  of  $(\Sigma_r G)_\lambda$  such that  $|V''| = d + 1$  and  $\mathfrak{P}_{i,j} \neq \emptyset$  for each  $v_{i,j} \in V''$ . It is straightforward to show that

$$\mathfrak{P} := (V'', \delta'') := \{v_{j,r-2}^1, v_i^a, v_{i,r-1}^1, v_{k,1}^1\} \sqcup \{v_m^1 \mid m \in \{1, \dots, d\} \setminus \{i, j, k\}\}$$

is an  $f$ -weighted  $r$ -path vertex cover of  $(\Sigma_r G)_\lambda$ ,  $v_{j,r} \cdots v_{j,1} v_j \in \mathfrak{P}_{j,r-2}$ ,  $v_{i,r-1} \cdots v_{i,1} v_i v_k \in \mathfrak{P}_{i,r-1}$ ,  $v_{i,r-2} \cdots v_{i,1} v_i v_j v_{j,1} \in \mathfrak{P}_{i,0}$ ,  $v_{k,r} \cdots v_{k,1} v_k \in \mathfrak{P}_{k,1}$  and to show that  $v_{t,r} \cdots v_{t,1} v_t \in \mathfrak{P}_{t,0}$  for any

$t \in \{1, \dots, d\} \setminus \{i, j, k\}$ .

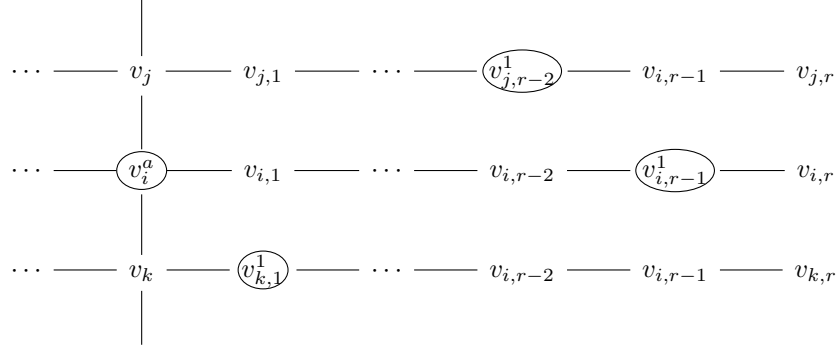

□

### 3.4 Sufficient Conditions for Cohen-Macaulayness

In this section, we prove the sufficient conditions for which the  $f$ -weighted  $r$ -path ideal of a weighted  $r$ -path suspension is Cohen-Macaulay for all  $r \geq 2$ .

**Theorem 3.4.1.** *Let  $(\Sigma_r G)_\lambda$  be a weighted  $r$ -path suspension of  $G_\omega$  such that the weight function  $\lambda$  satisfies the constraints in Propositions 3.2.1, 3.2.43, or 3.2.44 when  $r = 2$  or 3 or  $r \geq 4$ , respectively. Then  $I := I_{r,f}((\Sigma_r G)_\lambda)$  is Cohen-Macaulay,  $\{X_{i,j} - X_{i,j-1} \mid i = 1, \dots, d, j = 1, \dots, r\}$  is a homogeneous regular sequence for  $R'/I$ , and*

$$\frac{R'}{I + (X_{i,j} - X_{i,j-1} \mid i = 1, \dots, d, j = 1, \dots, r)R'} \cong \frac{R}{IR}.$$

*Proof.* For  $k = 1, \dots, (r-1)d$ , let  $i_k = \lfloor \frac{k+d-1}{d} \rfloor$ ,  $j_k = k + (1 - i_k)d$  and

$$\underline{n}_k = (\underbrace{r - i_k + 1, \dots, r - i_k + 1}_{j_k \text{ times}}, \underbrace{r - i_k + 2, \dots, r - i_k + 2}_{d - j_k \text{ times}}) \in \mathbb{N}^d.$$

For  $k = 1, \dots, (r-1)d$ , define a polynomial ring  $R_k$  by

$$R_k = A \begin{bmatrix} 0, & \cdots & 0, & X_{j_k+1, r-i_k+1}, & \cdots & X_{d, r-i_k+1} \\ X_{1, r-i_k}, & \cdots & X_{j_k, r-i_k}, & X_{j_k+1, r-i_k}, & \cdots & X_{d, r-i_k}, \\ \vdots & \ddots & \vdots & \vdots & \ddots & \vdots \\ X_{1,0}, & \cdots & X_{j_k,0}, & X_{j_k+1,0}, & \cdots & X_{d,0} \end{bmatrix}.$$

The polynomial ring  $R_k$  has  $j_k(r - i_k + 1) + (d - j_k)(r - i_k + 2)$  variables. Then for  $k = 1, \dots, (r-1)d$ ,  $p_{\underline{n}_k}(I)R_k$  is the monomial ideal of  $R_k$  obtained from  $I$  by setting  $X_{a,b} = X_{a,r-i_k}$  for  $a = 1, \dots, j_k$  and  $b = r - i_k + 1, \dots, r$  and setting  $X_{a,b} = X_{a,r-i_k+1}$  for  $a = j_k + 1, \dots, d$  and  $b = r - i_k + 2, \dots, r$ .

Note that

$$\frac{R_1}{p_{\underline{n}_1}(I)} \cong \frac{R'}{I + (X_{1,r} - X_{1,r-1})},$$

and for  $k = 2, \dots, (r-1)d$  we have inductively

$$\begin{aligned} \frac{R_k}{p_{\underline{n}_k}(I)} &\cong \frac{R_{k-1}}{p_{\underline{n}_{k-1}}(I) + (X_{j_k,r-i_k+1} - X_{j_k,r-i_k})} \cong \frac{R_{k-1}/p_{\underline{n}_{k-1}}(I)}{(X_{j_k,r-i_k+1} - X_{j_k,r-i_k})} \\ &\cong \frac{R_{k-2}/(p_{\underline{n}_{k-2}}(I) + (X_{j_{k-1},r-i_{k-1}+1} - X_{j_{k-1},r-i_{k-1}}))}{(X_{j_k,r-i_k+1} - X_{j_k,r-i_k})} \\ &\cong \frac{R_{k-2}}{p_{\underline{n}_{k-2}}(I) + (X_{j_{k-1},r-i_{k-1}+1} - X_{j_{k-1},r-i_{k-1}}, X_{j_k,r-i_k+1} - X_{j_k,r-i_k})} \\ &\cong \dots \\ &\cong \frac{R_1}{p_{\underline{n}_1}(I) + (X_{j_l,r-i_l+1} - X_{j_l,r-i_l} \mid l = 2, \dots, k)} \\ &\cong \frac{R'}{I + (X_{j_l,r-i_l+1} - X_{j_l,r-i_l} \mid l = 1, \dots, k)}, \end{aligned}$$

since  $j_1 = 1$ ,  $r - i_1 + 1 = r - 1 + 1 = r$  and  $r - i_1 = r - 1$ . Hence

$$\begin{aligned} \frac{R}{IR} &= \frac{R_{(r-1)d}}{p_{\underline{n}_{(r-1)d}}(I)} \cong \frac{R'}{I + (X_{j_l,r-j_l+1} - X_{j_l,r-j_l} \mid l = 1, \dots, (r-1)d)} \\ &= \frac{R'}{I + (X_{i,j} - X_{i,j-1} \mid i = 1, \dots, d, j = 2, \dots, r)}. \end{aligned}$$

Let  $k \in \{1, \dots, (r-1)d\}$ . We set  $R_0 := R'$  and  $\underline{n}_0 := (r+1, \dots, r+1)$ . Then by Propositions 3.2.1, 3.2.43 and 3.2.44, for any  $(V'', \delta'')$  such that  $P(V'', \delta'')$  occurs in an irredundant  $m$ -irreducible decomposition of  $p_{\underline{n}_{k-1}}(I)$ , we have that there exists a unique  $v_{i,i_\alpha} \in V''$  for  $i = 1, \dots, d$ . So in  $R_{k-1}/p_{\underline{n}_{k-1}}(I)$ , the associated primes of  $0 = p_{\underline{n}_{k-1}}(I)/p_{\underline{n}_{k-1}}(I)$  are of the form  $\overline{(X_{1,\beta_1}, \dots, X_{d,\beta_d})R_{k-1}}$ . So we have that  $X_{j_k,r-i_k+1} - X_{j_k,r-i_k} \in \text{NZD}_R(R_{k-1}/p_{\underline{n}_{k-1}}(I))$ . So we have that  $X_{j_k,r-i_k+1} - X_{j_k,r-i_k}$  is  $R_{k-1}/p_{\underline{n}_{k-1}}(I)$ -regular. Thus, by the definition of the  $R'/I$ -regular sequence, we have

$$\{X_{i,j} - X_{i,j-1} \mid i = 1, \dots, d, j = 2, \dots, r\} = \{X_{j_l,r-j_l+1} - X_{j_l,r-j_l} \mid l = 1, \dots, (r-1)d\}$$



is a homogeneous regular sequence for  $R'/I$ . Since  $R/IR$  is Artinian, it is Cohen-Macaulay. So by Fact 2.5.5, we have that  $R'/I$  is Cohen-Macaulay.  $\square$

### 3.5 Main Results

The main results of this chapter are in Theorems 3.5.5 and 3.5.6.

**Corollary 3.5.1.** Let  $f = \max$ . Then the constraints for  $\lambda$  in Propositions 3.2.1, 3.2.43, and 3.2.44 become

$$\lambda(v_i v_j) \leq \min\{\lambda(v_i v_{i,1}), \lambda(v_j v_{j,1})\}, \forall v_i v_j \in E(G).$$

**Corollary 3.5.2.** Let  $f = \text{lcm}$ . Then the constraints for  $\lambda$  in Propositions 3.2.1, 3.2.43, and 3.2.44 become

$$\lambda(v_i v_j) \mid \lambda(v_i v_{i,1}) \text{ and } \lambda(v_i v_j) \mid \lambda(v_j v_{j,1}), \forall v_i v_j \in E(G).$$

**Corollary 3.5.3.** Let  $f = \min$ . Then the constraints for  $\lambda$  in Proposition 3.2.1, 3.2.43, and 3.2.44 become

$$\lambda(v_i v_j) \leq \min\{\lambda(v_i v_{i,1}), \lambda(v_j v_{j,1})\}, \forall v_i v_j \in E(G),$$

$$\lambda(v_{i,k}, v_{i,k+1}) \leq \lambda(v_{i,k+1} v_{i,k+2}), \forall i = 1, \dots, d \text{ and } k = 0, \dots, r-2,$$

and

$$\left\{ \begin{array}{ll} \lambda(v_i v_j) \geq \lambda(v_j v_k) \text{ or } \lambda(v_k v_l) \geq \lambda(v_j v_k) \text{ for all 3-paths } v_i v_j v_k v_l \text{ in } G, & \text{if } r = 2, \\ \lambda(v_i v_j) \geq \lambda(v_j v_k) \text{ or } \lambda(v_l v_m) \geq \lambda(v_k v_l) \text{ for all 4-paths } v_i v_j v_k v_l v_m \text{ in } G, \text{ and} & \\ \text{the weights on edges satisfy } a = b \geq c \text{ for all 3-cycles in } G, & \text{if } r = 3, \\ \text{all edges in } G \text{ have the same weight} & \text{if } r \geq 4. \end{array} \right.$$

*Proof.* We first show the equivalence for weight constraints on 4-paths in  $G$  when  $r = 3$ . Let  $v_i v_j v_k v_l v_m$  be a 4-path in  $G$ . On one hand, let  $\lambda(v_i v_j) \geq \lambda(v_j v_k)$  or  $\lambda(v_l v_m) \geq \lambda(v_k v_l)$ , then by Notation 3.2.2(a), we have that  $\min(\lambda(v_i v_j), \lambda(v_j v_k)) = \lambda(v_j v_k) \geq \lambda(v_j v_k)$  or  $\min(\lambda(v_k v_l), \lambda(v_l v_m)) = \lambda(v_k v_l) \geq \lambda(v_k v_l)$ , so Notation 3.2.2(d) holds. On the other hand, without loss of generality, assume that  $\lambda(v_i v_j) < \lambda(v_j v_k)$ , then  $\min\{\lambda(v_{j,1} v_j), \lambda(v_j v_i)\} = \lambda(v_j v_i) < \lambda(v_j v_k)$  by Notation 3.2.2(a) and  $\min(\lambda(v_i v_j), \lambda(v_j v_k)) < \lambda(v_j v_k)$ , so  $\min(\lambda(v_k v_l), \lambda(v_l v_m)) \geq \lambda(v_k v_l)$  by Notation 3.2.2(d). Hence  $\lambda(v_l v_m) \geq \lambda(v_k v_l)$ .

We then show the equivalence for weight constraints on 3-cycles in  $G$  when  $r = 3$ . Let  $v_i v_j v_k v_i$  be a 3-cycle in  $G$ . On one hand, let the weights on edges of the 3-cycle  $v_i v_j v_k v_i$  satisfy  $a = b \geq c$ , without loss of generality, assume that  $\lambda(v_i v_j) \leq \lambda(v_j v_k) = \lambda(v_k v_i)$ , then we have that

$$\min(\lambda(v_j v_i), \lambda(v_j v_k)) = \lambda(v_j v_i) < \lambda(v_j v_k) = \max\{\lambda(v_j v_i), \lambda(v_j v_k)\}$$

and  $\min(\lambda(v_k v_i), \lambda(v_k v_j)) = \lambda(v_k v_j) \geq \lambda(v_k v_i)$ , and  $\min(\lambda(v_k v_i), \lambda(v_k v_j)) = \lambda(v_k v_j) \geq \lambda(v_k v_i)$ , so we proved Notations 3.2.2(e)(1) and (e)(2)(i), it is straightforward to show that Notations (e)(2)(ii) and (e)(2)(iii) hold. On the other hand, if  $\lambda(v_i v_j) = \lambda(v_j v_k) = \lambda(v_k v_i)$ , then we are done, so without loss of generality, assume  $\lambda(v_i v_j) < \lambda(v_i v_k)$ , then  $\min(\lambda(v_i v_{i,1}), \lambda(v_i v_j)) < \min(\lambda(v_i v_{i,1}), \lambda(v_i v_k))$  by Notation 3.2.2(a), so  $\min(\lambda(v_k v_i), \lambda(v_k v_j)) \geq \lambda(v_k v_j)$  by Notation 3.2.2(e)(1), hence  $\lambda(v_k v_i) \geq \lambda(v_k v_j)$ , similarly, we have  $\min(\lambda(v_i v_{i,1}), \lambda(v_i v_j)) < \lambda(v_i v_k)$ , so  $\min(\lambda(v_k v_i), \lambda(v_k v_j)) \geq \lambda(v_k v_i)$  by Notation 3.2.2(e)(2), so  $\lambda(v_k v_j) \geq \lambda(v_k v_i)$ , hence  $\lambda(v_k v_i) \geq \lambda(v_k v_j) \geq \lambda(v_k v_i)$  and so  $\lambda(v_k v_i) = \lambda(v_k v_j) > \lambda(v_i v_j)$ .

We show there is no weight constraint on any 4-cycles in  $G$ . It suffices to show that Notation 3.2.2(f)(2) holds automatically provided that  $f = \min$ . It is straightforward to show that Notations (f)(2)(i), (f)(2)(ii), (f)(2)(iv) and (f)(2)(v) holds automatically. But Notation 3.2.2(2)(iii) is equivalent to either that  $\lambda(v_k v_j) \geq \lambda(v_k v_l)$ , that  $\lambda(v_l v_i) \geq \lambda(v_l v_k)$ , or that  $(\lambda(v_k v_l) \geq \lambda(v_k v_j)$  and  $\lambda(v_l v_k) \geq \lambda(v_l v_i))$ , which is equivalent to  $\lambda(v_k v_l) \leq \max\{\lambda(v_k v_j), \lambda(v_l v_i)\}$  or  $\lambda(v_k v_l) \geq \max\{\lambda(v_k v_j), \lambda(v_l v_i)\}$ , but this holds automatically.

It is straightforward to show the equivalence for  $r = 2$  and  $r \geq 4$ . □

**Corollary 3.5.4.** Let  $f = \gcd$ . Then the constraints for  $\lambda$  in Notation 3.2.2 become

$$\lambda(v_i v_j) \mid \lambda(v_i v_{i,1}) \text{ and } \lambda(v_i v_j) \mid \lambda(v_j v_{j,1}), \forall v_i v_j \in E(G),$$

$$\lambda(v_{i,k}, v_{i,k+1}) \mid \lambda(v_{i,k+1} v_{i,k+2}), \forall i = 1, \dots, d \text{ and } k = 0, \dots, r-2,$$

and

(a) if  $r = 2$ , then  $\lambda(v_j v_k) \mid \lambda(v_i v_j)$  or  $\lambda(v_j v_k) \mid \lambda(v_k v_l)$  for all 3-paths  $v_i v_j v_k v_l$  in  $G$ ,

(b) if  $r = 3$ , then

(1) for all 4-paths  $v_i v_j v_k v_l v_m$  in  $G$ : if  $\lambda(v_j v_i) < \lambda(v_j v_k)$ , then  $\lambda(v_k v_l) \mid \lambda(v_l v_m)$ ,

(2) for all 3-cycles  $v_i v_j v_k v_i$  in  $G$ : if  $\lambda(v_i v_j) < \lambda(v_i v_k)$ , then  $\lambda(v_k v_i) = \lambda(v_k v_j)$  and

$$\gcd(\lambda(v_j v_i), \lambda(v_j v_{n,0})) \leq \max\{\gcd(\lambda(v_j v_i), \lambda(v_j v_k)), \gcd(\lambda(v_j v_k), \lambda(v_j v_{n,0}))\}$$

$$\forall v_j v_{n,0} \in E(G) \text{ with } i \neq n \neq k,$$

(3) for all 4-cycles  $v_i v_j v_k v_l v_i$ : if  $\lambda(v_i v_j) < \lambda(v_i v_l)$ , then

$$\left\{ \begin{array}{l} \text{either } (\lambda(v_k v_l) \mid \lambda(v_k v_j) \text{ and } \lambda(v_j v_i) \mid \lambda(v_j v_k)), \\ \lambda(v_l v_i) \mid \lambda(v_l v_k), \\ \text{or } \lambda(v_l v_k) \mid \lambda(v_l v_i), \end{array} \right.$$

and

$$\left\{ \begin{array}{l} \text{either } \lambda(v_k v_l) \mid \lambda(v_k v_j), \\ \lambda(v_l v_k) \mid \lambda(v_l v_i), \\ \text{or } (\lambda(v_k v_j) \mid \lambda(v_k v_l) \text{ and } \lambda(v_l v_i) \mid \lambda(v_l v_k)), \end{array} \right.$$

(c) if  $r \geq 4$ , then all edges in  $G$  have the same weight.

*Proof.* We first show the equivalence for weight constraints on 4-paths in  $G$  when  $r = 3$ . Let  $v_i v_j v_k v_l v_m$  be a 4-path in  $G$ . On one hand, let  $\lambda(v_i v_j) < \lambda(v_j v_k)$  and assume that  $\lambda(v_k v_l) \mid \lambda(v_l v_m)$ , then  $\gcd(\lambda(v_k v_l), \lambda(v_l v_m)) = \lambda(v_k v_l) \geq \lambda(v_k v_l)$ , so Notation 3.2.2(d) holds. On the other hand, assume that  $\lambda(v_i v_j) < \lambda(v_j v_k)$ , then  $\gcd(\lambda(v_j v_l), \lambda(v_j v_i)) = \lambda(v_j v_i) < \lambda(v_j v_k)$  by Notation 3.2.2(a) and  $\gcd(\lambda(v_i v_j), \lambda(v_j v_k)) < \lambda(v_j v_k)$ , so  $\gcd(\lambda(v_k v_l), \lambda(v_l v_m)) \geq \lambda(v_k v_l)$  by Notation 3.2.2(d), hence  $\lambda(v_k v_l) \mid \lambda(v_l v_m)$ .

We then show the equivalence for weight constraints on 3-cycles in  $G$  when  $r = 3$ . Let  $v_i v_j v_k v_i$  be a 3-cycle in  $G$ . On one hand, let  $\lambda(v_i v_j) < \lambda(v_i v_k)$ , assume that  $\lambda(v_k v_i) = \lambda(v_k v_j)$  and that

$$\gcd(\lambda(v_j v_i), \lambda(v_j v_{n,0})) \leq \max\{\gcd(\lambda(v_j v_i), \lambda(v_j v_k)), \gcd(\lambda(v_j v_k), \lambda(v_j v_{n,0}))\}$$

$$\forall v_j v_{n,0} \in E(G) \text{ with } i \neq n \neq k,$$

then  $\gcd(\lambda(v_j v_i), \lambda(v_j v_k)) \leq \max\{\lambda(v_j v_i), \lambda(v_j v_k)\}$  and  $\gcd(\lambda(v_k v_i), \lambda(v_k v_j)) = \lambda(v_k v_j) \geq \lambda(v_k v_j)$ , and  $\gcd(\lambda(v_k v_i), \lambda(v_k v_j)) = \lambda(v_k v_i) \geq \lambda(v_k v_i)$ , so Notations 3.2.2(e)(1) and (e)(2)(i) was proved.

Hence it is straightforward to show that Notations 3.2.2(e)(2)(ii) and (e)(2)(iii) holds automatically.

On the other hand, then it is straightforward to show that we can deduce Notation 3.2.2(b)(2) in the corollary from Notation 3.2.2(e).  $\square$

**Theorem 3.5.5.** *Assume that  $H_\lambda$  is obtained by pruning a sequence of  $r$ -pathless leaves from  $G_\omega$  and that  $H_\lambda$  is an  $r$ -path suspension of a weighted graph  $\Gamma_\mu$ . Then the following conditions are equivalent:*

(i)  $I_{r,f}(G_\omega)$  is Cohen-Macaulay;

(ii)  $I_{r,f}(G_\omega)$  is unmixed; and

(iii) the weight function  $\lambda$  satisfies the constraints in Propositions 3.2.1, 3.2.43, or 3.2.44 when  $r = 2$  or 3 or  $r \geq 4$ , respectively, where we rename the vertices of  $H_\lambda$  such that  $V(\Gamma_\mu) = \{v_i \mid i = 1, \dots, d\}$ ,

$$V(H_\lambda) = \{v_{i,j} \mid i = 1, \dots, d, j = 0, \dots, r\} \text{ with } v_{i,0} = v_i, \forall i = 1, \dots, d,$$

and  $\{v_{i,0}v_{i,1} \cdots v_{i,r}\}_{i=1}^d$  are all the  $d$   $r$ -whiskers.

*Proof.* (i) $\implies$ (ii) follows from Fact 2.7.8.

(ii) $\implies$ (iii) Assume that  $I_{r,f}(G_\omega)$  is unmixed. By Lemma 3.1.11(b),  $I_{r,f}(H_\lambda)$  is also unmixed. Then Statement (iii) follows from Theorem 3.3.2, 3.3.3 and 3.3.4.

(iii) $\implies$ (i) Assume condition (iii) holds. Then Theorem 3.4.1 implies that  $I_{r,f}(H_\lambda)$  is Cohen-Macaulay. So Lemma 3.1.11(c) implies that  $I_{r,f}(G_\omega)$  is as well.  $\square$

Because of the following fact and Theorem 3.4.1, the main result of this chapter gives a formula to compute  $r_R(R/I_{r,f}(G_\omega))$  for all trees such that  $R/I_{r,f}(G_\omega)$  is Cohen-Macaulay.

**Theorem 3.5.6.** *Assume that  $G_\omega$  is a weighted tree. Then the following conditions are equivalent:*

(i)  $I_{r,f}(G_\omega)$  is Cohen-Macaulay;

(ii)  $I_{r,f}(G_\omega)$  is unmixed; and

(iii) there exists a weighted tree  $\Gamma_\mu$  and an  $r$ -path suspension  $H_\lambda$  of  $\Gamma_\mu$  such that  $H_\lambda$  is obtained by pruning a sequence of  $r$ -pathless leaves from  $G_\omega$ , the weight function  $\lambda$  satisfies the constraints in Propositions 3.2.1, 3.2.43, or 3.2.44 when  $r = 2$  or 3 or  $r \geq 4$ , respectively, where we rename the

vertices of  $H_\lambda$  such that we have that  $V(\Gamma_\mu) = \{v_i \mid i = 1, \dots, d\}$ ,

$$V(H_\lambda) = \{v_{i,j} \mid i = 1, \dots, d, j = 0, \dots, r\} \text{ with } v_{i,0} = v_i, \forall i = 1, \dots, d,$$

and  $\{v_{i,0}v_{i,1} \cdots v_{i,r}\}_{i=1}^d$  are all the  $d$   $r$ -whiskers.

*Proof.* (iii) $\implies$ (i) $\implies$ (ii) follows from Proposition 3.5.5.

(ii) $\implies$ (iii) Assume that  $I_{r,f}$  is unmixed. Since  $G$  is finite, we prune a sequence of  $r$ -pathless leaves from  $G_\omega$  to obtain a weighted graph  $H_\lambda$  that has no  $r$ -pathless leaves. Lemma 3.1.11(b) implies that  $I_{r,f}(H_\lambda)$  is unmixed. So we have that  $I_r(H_\lambda)$  is unmixed by Lemma 3.1.8. Hence  $H$  is an  $r$ -path suspension of a tree  $\Gamma$  by [2, Theorem 3.8 and Remark 3.9]. Finally, Proposition 3.5.5 implies the weight conditions on  $E(H_\lambda)$ .  $\square$

## Chapter 4

# Cohen-Macaulay Type of Weighted $r$ -Path Ideals

Let  $\mathbb{K}$  be a field,  $d \geq 2$ ,  $R = \mathbb{K}[X_1, \dots, X_d]$  and  $\mathfrak{m} = (X_1, \dots, X_d)R$ . Let  $G = (V, E)$  be a (finite simple) graph with vertex set  $V = \{v_1, \dots, v_d\}$  and edge set  $E$ . Let  $r \geq 1$  be a positive integer and  $R' = \mathbb{K}[\{X_{i,j} \mid i = 1, \dots, d, j = 0, \dots, r\}]$ .

In this chapter, we compute the type of the rings  $R/I_r(G_\omega)$  when they are Cohen-Macaulay. This main result is in Theorem 4.2.25.

### 4.1 Background

**Definition 4.1.1.** The *weighted  $r$ -path ideal* associated to  $G_\omega$  is the ideal  $I_r(G_\omega) := I_{r, \max}(G_\omega) \subseteq R$  that is generated by the max-weighted paths in  $G$  of length  $r$ :

$$I_r(G_\omega) = \left( X_{i_1}^{e_{i_1}} \cdots X_{i_{r+1}}^{e_{i_{r+1}}} \left| \begin{array}{l} v_{i_1} \cdots v_{i_{r+1}} \text{ is a path in } G \text{ with } e_{i_1} = \omega(v_{i_1} v_{i_2}), \\ e_{i_j} = \max(\omega(v_{i_{j-1}} v_{i_j}), \omega(v_{i_j}, v_{i_{j+1}})) \text{ for } 1 < j \leq r \\ \text{and } e_{i_{r+1}} = \omega(v_{i_r} v_{i_{r+1}}) \end{array} \right. \right) R.$$

**Remark.** (a)  $I_r(G_1) = I_r(G)$ , where  $1 : E \rightarrow \mathbb{N}$  is the constant function  $1(e) = 1$ .

(b)  $I_1(G_\omega) = I(G_\omega)$ .

**Example 4.1.2.** Consider the following weighted graph  $(\Sigma_2 P_2)_\lambda$  from Example 3.1.17.

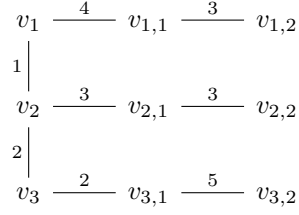

Then the weighted 2-path ideal of  $(\Sigma_2 P_2)_\lambda$  is

$$\begin{aligned}
 I_2((\Sigma_2 P_2)_\lambda) = & (X_{1,2}^3 X_{1,1}^4 X_1^4, X_{1,1}^4 X_1^4 X_2, X_1 X_2^3 X_{2,1}^3, X_1 X_2^2 X_3^2, X_{2,2}^3 X_{2,1}^3 X_2^3, \\
 & X_{2,1}^3 X_2^3 X_3^2, X_2^2 X_3^2 X_{3,1}^2, X_{3,2}^5 X_{3,1}^5 X_3^2) R'.
 \end{aligned}$$

**Example 4.1.3.** The minimal weighted 2-path vertex covers of  $(\Sigma_2 P_2)_\lambda$  from Example 3.1.17 are displayed in the following sketches. In each diagram, all of the vertices encompassed by a circle form a weighted 2-path vertex cover of  $(\Sigma_2 P_2)_\lambda$ .

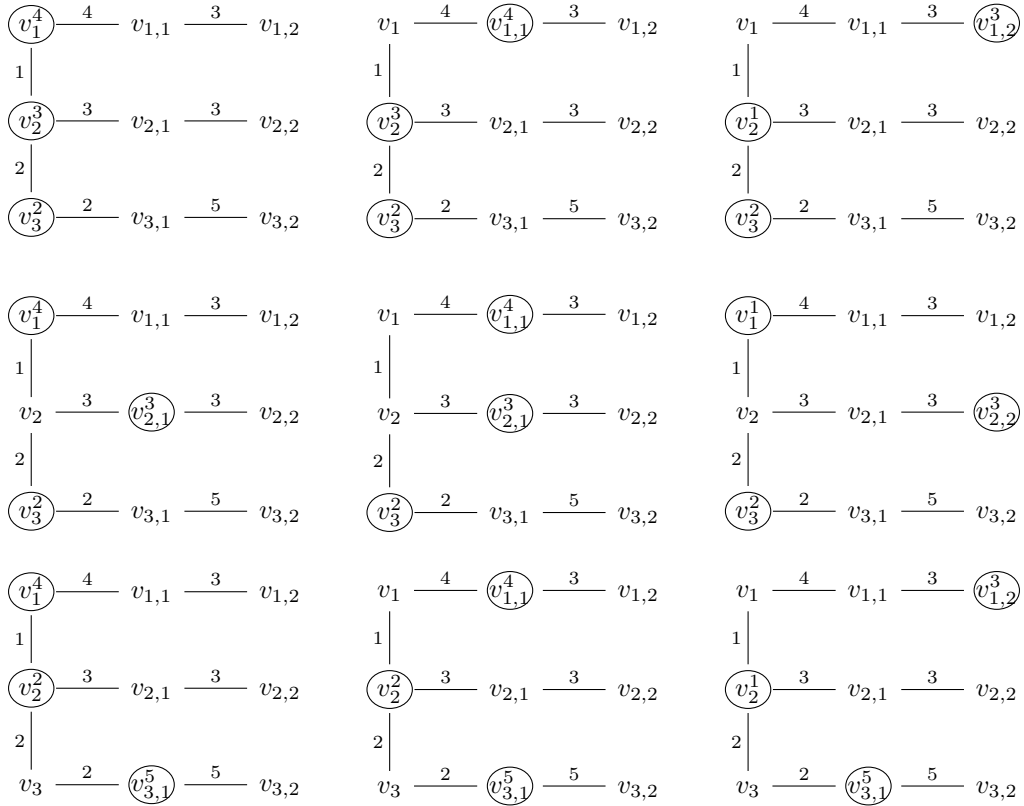

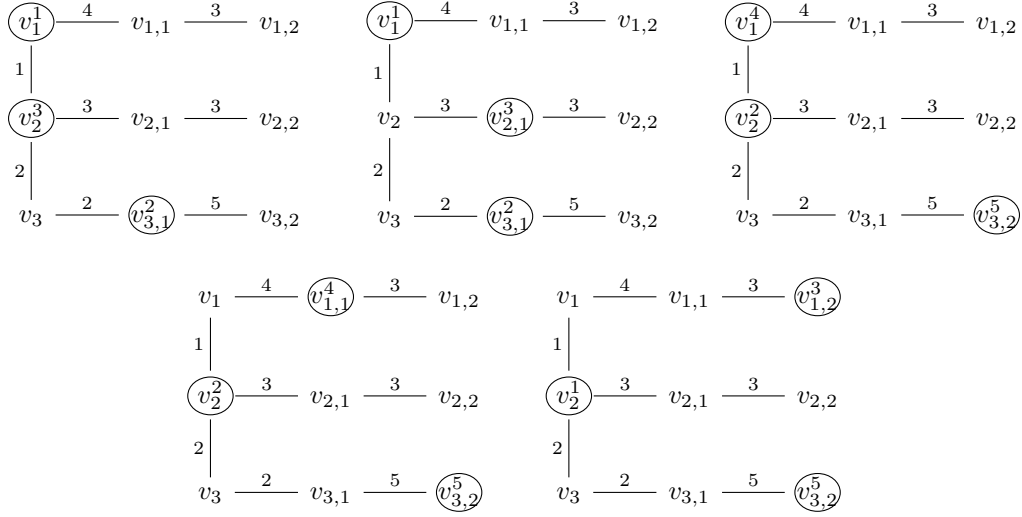

**Example 4.1.4.** Consider the following graph  $(\Sigma_2 P_2)_\lambda$  from Example 3.1.17.

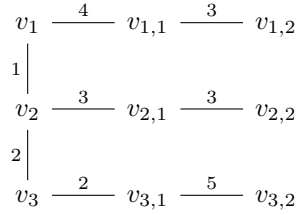

By Fact 3.1.7 and Example 4.1.3, the irredundant m-irreducible decomposition of  $I_2((\Sigma_2 P_2)_\lambda)$  is

$$\begin{aligned}
I_2((\Sigma_2 P_2)_\lambda) &= (X_1^4, X_2^3, X_3^2)R' \cap (X_{1,1}^4, X_2^3, X_3^2)R' \cap (X_{1,2}^3, X_2, X_3^2)R' \cap (X_1^4, X_{2,1}^3, X_3^2)R' \\
&\cap (X_{1,1}^4, X_{2,1}^3, X_3^2)R' \cap (X_1, X_{2,2}^3, X_3^2)R' \cap (X_1^4, X_2^2, X_{3,1}^5)R' \cap (X_{1,1}^4, X_2^2, X_{3,1}^5)R' \\
&\cap (X_{1,2}^3, X_2, X_{3,1}^5)R' \cap (X_1, X_2^3, X_{3,1}^2)R' \cap (X_1, X_{2,1}^3, X_{3,1}^2)R' \cap (X_1^4, X_2^2, X_{3,2}^5)R' \\
&\cap (X_{1,1}^4, X_2^2, X_{3,2}^5)R' \cap (X_{1,2}^3, X_2, X_{3,2}^5)R'.
\end{aligned}$$

**Definition 4.1.5.** Let  $(\Sigma_r G)_\lambda$  be a weighted  $r$ -path suspension of  $G_\omega$ . Consider the ideal  $\mathfrak{m}^{[a(\lambda)]} = (X_1^{a_1}, \dots, X_d^{a_d})R$ , where for  $i = 1, \dots, d$ ,  $a_i = \sum_{k=0}^r e_{i,k}$  with

$$e_{i,k} = \begin{cases} \lambda(v_i v_{i,1}) & \text{if } k = 0, \\ \max\{\lambda(v_{i,k-1} v_{i,k}), \lambda(v_{i,k} v_{i,k+1})\} & \text{if } k = 1, \dots, r-1, \\ \lambda(v_{i,r-1} v_{i,r}) & \text{if } k = r. \end{cases}$$



In words,  $\mathfrak{m}^{a(\lambda)}$  is the monomial ideal of  $R$  obtained from the monomial ideal  $(g_1, \dots, g_d)R'$  by setting  $\mathfrak{m}^{a(\lambda)} = (p(g_1), \dots, p(g_d))R$ , where  $g_i$  is the corresponding generator in  $I_r((\Sigma_r G)_\lambda)$  of the  $r$ -whisker  $v_i v_{i,1} \dots v_{i,r}$  from  $(\Sigma_r G)_\lambda$  for  $i = 1, \dots, d$ .

**Example 4.1.6.** In Example 4.1.4,  $\mathfrak{m}^{[a(\lambda)]} = (X_1^{a_1}, X_2^{a_2}, X_3^{a_3})R$  with

$$\begin{aligned} a_1 &= \sum_{k=0}^2 e_{1,k} = \lambda(v_1 v_{1,1}) + \max\{\lambda(v_1 v_{1,1}), \lambda(v_{1,1} v_{1,2})\} + \lambda(v_{1,1} v_{1,2}) = 4 + 4 + 3 = 11, \\ a_2 &= \sum_{k=0}^2 e_{2,k} = \lambda(v_2 v_{2,1}) + \max\{\lambda(v_2 v_{2,1}), \lambda(v_{2,1} v_{2,2})\} + \lambda(v_{2,1} v_{2,2}) = 3 + 3 + 3 = 9, \\ a_3 &= \sum_{k=0}^2 e_{3,k} = \lambda(v_3 v_{3,1}) + \max\{\lambda(v_3 v_{3,1}), \lambda(v_{3,1} v_{3,2})\} + \lambda(v_{3,1} v_{3,2}) = 2 + 5 + 5 = 12. \end{aligned}$$

**Fact 4.1.7.** It is straightforward to show that

$$I_r((\Sigma_r G)_\lambda)R = I_r((\Sigma_{r-1} G)_{\lambda'})R + \mathfrak{m}^{[a(\lambda)]}, \text{ where } \lambda' = \lambda|_{\Sigma_{r-1} G}.$$

Because of the following fact, the main result of this chapter gives a formula to compute  $r_R(R/I_r(G_\omega))$  for all trees such that  $R/I_r(G_\omega)$  is Cohen-Macaulay.

**Fact 4.1.8.** [7, Proposition 3.7 and Theorem 3.11] Let  $(\Sigma_r G)_\lambda$  be a weighted  $r$ -path suspension of  $G_\omega$  such that  $\lambda(v_i v_j) \leq \min\{\lambda(v_i, v_{i,1}), \lambda(v_j, v_{j,1})\}$  for all edges  $v_i v_j \in E$ .

(a)  $R'/I_r((\Sigma_r G)_\lambda)$  is Cohen-Macaulay.

(b) If  $\Gamma_{\lambda'}$  is a weighted tree and  $R/I_r(\Gamma_{\lambda'})$  is Cohen-Macaulay, then there exists a weighted tree  $H_{\omega'}$  such that  $(\Sigma_r H)_{\lambda''}$  is obtained by pruning a sequence of  $r$ -pathless leaves from  $\Gamma_{\lambda'}$  with  $\lambda'' = \lambda'|_{\Sigma_r H}$  and the weight function  $\lambda'$  satisfies the above condition.

## 4.2 Type

**Definition 4.2.1.** Let  $(\Sigma_{r-1} G)_\lambda$  be a weighted  $(r-1)$ -path suspension of  $G_\omega$ . We define  $q : V((\Sigma_{r-1} G)_\lambda) \rightarrow V(G)$  as  $q(v_{i,j}) = v_i$ . Let  $\mathfrak{P} := (V'', \delta'')$  be such that  $V'' \subseteq V((\Sigma_{r-1} G)_\lambda)$  and  $\delta'' : V'' \rightarrow \mathbb{N}$ . Then

$$q(V'') = \{v_i \mid \exists v_{i,j} \in V''\}.$$

Set

$$\text{WCA}_i(\mathfrak{P}) = \{v_{i,j} \in V'' \mid \delta''(v_{i,j}) \leq \lambda(v_{i,j}v) \text{ for some edge } v_{i,j}v \text{ in } (\Sigma_{r-1}G)_\lambda\}, \forall i = 1, \dots, d,$$

and

$$h_{i,k} = \max\{\lambda(v_{i,k}v) \mid v_{i,k}v \in E((\Sigma_{r-1}G)_\lambda)\}, \forall i = 1, \dots, d, k = 0, \dots, r-1.$$

Define

$$\begin{aligned} \gamma_{(V'', \delta'')} : q(V'') &\longrightarrow \mathbb{N} \sqcup \{\infty\} \\ v_i &\longmapsto \begin{cases} \min\{\delta''(v_{i,j}) + \sum_{k=0}^{j-1} h_{i,k} \mid v_{i,j} \in \text{WCA}_i(\mathfrak{P})\} & \text{if } \text{WCA}_i(\mathfrak{P}) \neq \emptyset, \\ \infty & \text{otherwise.} \end{cases} \end{aligned}$$

**Proposition 4.2.2.** Let  $(\Sigma_{r-1}G)_\lambda$  be a weighted  $(r-1)$ -path suspension of  $G_\omega$ . Let  $\mathfrak{P} := (V'', \delta'')$  be such that  $V'' \subseteq V((\Sigma_{r-1}G)_\lambda)$  and  $\delta'' : V'' \rightarrow \mathbb{N}$ . Assume that  $\text{WCA}_i(\mathfrak{P}) \neq \emptyset$  for some  $i \in \{1, \dots, d\}$ .

If  $v_{i,j_1}, v_{i,j_2} \in \text{WCA}_i(\mathfrak{P})$  with  $j_1 < j_2$ , then

$$\delta''(v_{i,j_1}) + \sum_{k=0}^{j_1-1} h_{i,k} < \delta''(v_{i,j_2}) + \sum_{k=0}^{j_2-1} h_{i,k}.$$

So we have that

$$\gamma_{(V'', \delta'')} (v_i) = \delta''(v_{i,j_0}) + \sum_{k=0}^{j_0-1} h_{i,k}, \text{ where } j_0 := \min\{j \mid v_{i,j} \in \text{WCA}_i(\mathfrak{P})\}.$$

*Proof.* Suppose that  $\delta''(v_{i,j_1}) + \sum_{k=0}^{j_1-1} h_{i,k} \geq \delta''(v_{i,j_2}) + \sum_{k=0}^{j_2-1} h_{i,k}$ . Then we have that  $\delta''(v_{i,j_1}) \geq \delta''(v_{i,j_2}) + \sum_{k=j_1}^{j_2-1} h_{i,k}$ . So we have that

$$h_{i,j_1} < \delta''(v_{i,j_2}) + h_{i,j_1} \leq \delta''(v_{i,j_2}) + \sum_{k=j_1}^{j_2-1} h_{i,k} \leq \delta''(v_{i,j_1}), \text{ i.e., } h_{i,j_1} < \delta''(v_{i,j_1}).$$

Hence we get that  $\delta''(v_{i,j_1}) > h_{i,j_1} = \{\lambda(v_{i,j_1}v) \mid v_{i,j_1}v \in E((\Sigma_{r-1}G)_\lambda)\}$ , contradicting the definition of  $\text{WCA}_i(\mathfrak{P})$  and that  $v_{i,j_1} \in \text{WCA}_i(\mathfrak{P})$ .  $\square$

**Example 4.2.3.** A weighted 2-path suspension  $(\Sigma_2 P_1)_\lambda$  of  $G_\omega := (P_1)_\omega = (v_1 \overset{2}{\text{---}} v_2)$  with a

weighted 3-path vertex cover  $\mathfrak{P} := (V'', \delta'')$  of  $(\Sigma_2 P_1)_\lambda$  is given in the following sketch:

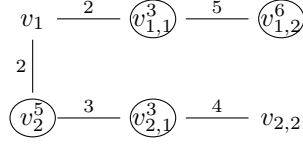

Since  $I_3((\Sigma_2 P_1)_\lambda) = (X_{1,2}^5 X_{1,1}^5 X_1^2 X_2^2, X_{1,1}^2 X_1^2 X_2^3 X_{2,1}^3, X_1^2 X_2^3 X_{2,1}^4 X_{2,2}^4) R'$ , we have

$$I_3((\Sigma_2 P_1)_\lambda) R = (X_1^{12} X_2^2, X_1^4 X_2^6, X_1^2 X_2^{11}) R.$$

Note that  $q(V'') = \{v_1, v_2\}$ . Since  $\delta''(v_{1,1}) = 3 < 5 = \lambda(v_{1,1} v_{1,2})$  and  $\delta''(v_{1,2}) = 6 > 5 = \lambda(v_{1,1} v_{1,2})$ , we have that  $\text{WCA}_1(\mathfrak{P}) = \{v_{1,1}\}$ . Similarly, we have that  $\text{WCA}_2(\mathfrak{P}) = \{v_{2,1}\}$ , and so

$$\begin{aligned}
 \gamma_{(V'', \delta'')}(v_1) &= \delta''(v_{1,1}) + \sum_{k=0}^{1-1} h_{1,k} = \delta''(v_{1,1}) + \max\{\lambda(v_1 v_2), \lambda(v_1 v_{1,1})\} = 3 + \max\{2, 2\} = 5, \\
 \gamma_{(V'', \delta'')}(v_2) &= \delta''(v_{2,1}) + \sum_{k=0}^{1-1} h_{2,k} = \delta''(v_{2,1}) + \max\{\lambda(v_1 v_2), \lambda(v_2 v_{2,1})\} = 3 + \max\{2, 3\} = 6.
 \end{aligned}$$

Therefore,  $P(V'', \gamma_{(V'', \delta'')}) = (X_1^5, X_2^6) R \supseteq (X_1^{12} X_2^2, X_1^4 X_2^6, X_1^2 X_2^{11}) R = I_3((\Sigma_2 P_1)_\lambda) R$ .

The following theorem is a key for decomposing  $I_r((\Sigma_{r-1} G)_{\lambda'}) R$  with  $\lambda' = \lambda|_{\Sigma_{r-1} G}$  and hence  $I_r((\Sigma_r G)_\lambda) R$ . The proof is somewhat technical. The reader may wish to follow the argument with Example 4.2.3 as a motivating example.

**Theorem 4.2.4.** *Let  $(\Sigma_{r-1} G)_\lambda$  be a weighted  $(r-1)$ -path suspension of  $G_\omega$  such that  $\lambda(v_i v_j) \leq \lambda(v_i, v_{i,1})$  and  $\lambda(v_i v_j) \leq \lambda(v_j v_{j,1})$  for all edges  $v_i v_j \in E$ . Let  $\mathfrak{P} := (V'', \delta'')$  be such that  $V'' \subseteq V((\Sigma_{r-1} G)_\lambda)$  and  $\delta'' : V'' \rightarrow \mathbb{N}$ . Then  $I_r((\Sigma_{r-1} G)_\lambda) R \subseteq P(q(V''), \gamma_{(V'', \delta'')})$  if and only if  $(V'', \delta'')$  is a weighted  $r$ -path vertex cover of  $(\Sigma_{r-1} G)_\lambda$ .*

*Proof.*  $\implies$  Assume that  $I_r((\Sigma_{r-1} G)_\lambda) R \subseteq P(q(V''), \gamma_{(V'', \delta'')})$ . Let  $P_r := v_{p_1, q_1} \cdots v_{p_{r+1}, q_{r+1}}$  be an  $r$ -path in  $(\Sigma_{r-1} G)_\lambda$ . Set

$$e_{p_k, q_k} = \begin{cases} \lambda(v_{p_1, q_1} v_{p_2, q_2}) & \text{if } k = 1, \\ \max\{\lambda(v_{p_{k-1}, q_{k-1}} v_{p_k, q_k}), \lambda(v_{p_k, q_k} v_{p_{k+1}, q_{k+1}})\} & \text{if } k = 2, \dots, r, \\ \lambda(v_{p_r, q_r} v_{p_{r+1}, q_{r+1}}) & \text{if } k = r + 1. \end{cases}$$

Then  $X_{p_1}^{e_{p_1, q_1}} \dots X_{p_{r+1}}^{e_{p_{r+1}, q_{r+1}}} \in \llbracket I_r((\Sigma_{r-1}G)_\lambda)R \rrbracket \subseteq \llbracket P(q(V''), \gamma_{(V'', \delta'')}) \rrbracket$ . So we have that

$$X_{i_0}^{\gamma_{(V'', \delta'')}(v_{i_0})} \mid X_{p_1}^{e_{p_1, q_1}} \dots X_{p_{r+1}}^{e_{p_{r+1}, q_{r+1}}} \text{ for some } v_{i_0} \in q(V'').$$

Hence we have that  $v_{i_0} = v_{p_l}$  for some  $l \in \{1, \dots, r+1\}$  and

$$\min_{v_{i_0, j} \in \text{WCA}_{i_0}(\mathfrak{P})} \left\{ \delta''(v_{i_0, j}) + \sum_{k=0}^{j-1} h_{i_0, k} \right\} = \gamma_{(V'', \delta'')}(v_{i_0}) \leq \sum_{k=0}^{r+1} \mathbb{1}_k e_{p_k, q_k}, \text{ where } \mathbb{1}_k = \begin{cases} 1 & \text{if } p_k = i_0, \\ 0 & \text{otherwise.} \end{cases}$$

So we have that  $v_{p_l} = v_{i_0} \in q(V'')$ . Since  $P_r$  is an  $r$ -path in  $\Sigma_{r-1}G$ , we have that  $P_r$  is of the following form.

$$\begin{array}{ccccccc} & & v_{p_1+q_1, 0} & & & & \\ & & \parallel & & & & \\ & & v_{p_1, 0} & \text{-----} & v_{p_1, 1} & \text{-----} & \dots & \text{-----} & v_{p_1, q_1} \\ & & | & & & & & & \\ & & \vdots & & & & & & \\ & & | & & & & & & \\ & & v_{p_{r+1}, 0} & \text{-----} & v_{p_{r+1}, 1} & \text{-----} & \dots & \text{-----} & v_{p_{r+1}, q_{r+1}} \\ & & \parallel & & & & & & \\ & & v_{p_1+r-q_{r+1}, 0} & & & & & & \end{array}$$

where  $q_1$  or  $q_{r+1}$  may be 0. Let  $M_0 := \max_{1 \leq k \leq r+1} \{q_k \mid i_0 = p_k\}$ . Then we have that

$$M_0 = \begin{cases} q_1 & \text{if } i_0 = p_1, \\ q_{r+1} & \text{if } i_0 = p_{r+1}. \end{cases}$$

Since  $\gamma_{(V'', \delta'')}(v_i) < \infty$ , we have that  $\text{WCA}_{i_0}(\mathfrak{P}) \neq \emptyset$ . Set  $j_0 := \min\{j \mid v_{i_0, j} \in \text{WCA}_{i_0}(\mathfrak{P})\}$ . Then by Proposition 4.2.2, we have that

$$\delta''(v_{i_0, j_0}) + \sum_{k=0}^{j_0-1} h_{i_0, k} = \min_{v_{i_0, j} \in V''} \left\{ \delta''(v_{i_0, j}) + \sum_{k=0}^{j-1} h_{i_0, k} \right\} \leq \sum_{k=0}^{r+1} \mathbb{1}_k \cdot e_{p_k, q_k} = \sum_{k=0}^{M_0} e_{i_0, k}. \quad (4.2.4.1)$$

Suppose that  $j_0 > M_0$ . Then since  $e_{i_0, k} \leq h_{i_0, k}$  for  $k = 0, \dots, M_0$ , by Inequality (4.2.4.1), we have that

$$\delta''(v_{i_0, j_0}) + \sum_{k=0}^{M_0} e_{i_0, k} \leq \delta''(v_{i_0, j_0}) + \sum_{k=0}^{M_0} h_{i_0, k} \leq \delta''(v_{i_0, j_0}) + \sum_{k=0}^{j_0-1} h_{i_0, k} \leq \sum_{k=0}^{M_0} e_{i_0, k}, \text{ i.e., } \delta''(v_{i_0, j_0}) \leq 0,$$

contradicting  $\delta''(v_{i_0, j_0}) \geq 1$  by the definition of  $\delta''$ . So  $j_0 \leq M_0$  and there must exist a sub-path of  $P_r$  of the form

$$v_{i_0,0} \text{ --- } v_{i_0,1} \text{ --- } \cdots \text{ --- } v_{i_0,M_0}.$$

Since  $0 \leq j_0 \leq M_0$ , there exists a vertex in this path of the form  $v_{i_0, j_0} = v_{p_k, q_k}$  for some  $k$  in  $\{1, \dots, r+1\}$ . So  $v_{p_k, q_k} = v_{i_0, j_0} \in \text{WCA}_i(\mathfrak{P}) \subseteq V''$ .

(a) Assume that  $0 = j_0 < M_0$ . Since  $\lambda(v_i v_j) \leq \min\{\lambda(v_i, v_{i,1}), \lambda(v_j, v_{j,1})\}$  for all edges  $v_i v_j \in E$  and  $M_0 \geq 1$ , we have that  $e_{i_0,0} = \lambda(v_{i_0,0} v_{i_0,1}) = h_{i_0,0}$ . Since  $v_{i_0, j_0} \in \text{WCA}_{i_0}(\mathfrak{P})$ , we have that  $\delta''(v_{i_0,0}) \leq h_{i_0,0} = e_{i_0,0}$ .

(b) Assume that  $0 < j_0 < M_0$ . Since  $v_{i_0, j_0} \in \text{WCA}_{i_0}(\mathfrak{P})$ , we have that  $v_{i_0, j_0}$  weighted-covers the edge  $v_{i_0, j_0-1} v_{i_0, j_0}$  or  $v_{i_0, j_0} v_{i_0, j_0+1}$ , i.e.,  $\delta''(v_{i_0, j_0}) \leq \max\{\lambda(v_{i_0, j_0-1} v_{i_0, j_0}), \lambda(v_{i_0, j_0} v_{i_0, j_0+1})\} = e_{i_0, j_0}$ .

(c) Assume that  $j_0 = M_0$ . Since  $e_{i_0, k} \leq h_{i_0, k}$  for  $k = 0, \dots, j_0 - 1$ , by Inequality (4.2.4.1), we have

$$\delta''(v_{i_0, j_0}) + \sum_{k=0}^{j_0-1} e_{i_0, k} \leq \delta''(v_{i_0, j_0}) + \sum_{k=0}^{j_0-1} h_{i_0, k} \leq \sum_{k=0}^{M_0} e_{i_0, k} = \sum_{k=0}^{j_0} e_{i_0, k}, \text{ i.e., } \delta''(v_{i_0, j_0}) \leq e_{i_0, j_0}.$$

So  $v_{i_0, j_0}$  weighted-covers  $P_r$ . Thus,  $V''$  is a weighted  $r$ -path vertex cover of  $\Sigma_{r-1}G$ .

$\Leftarrow$  Assume that  $(V'', \delta'')$  is a weighted  $r$ -path vertex cover of  $(\Sigma_{r-1}G)_\lambda$ . We need to show that every monomial generator of  $I_r((\Sigma_{r-1}G)_\lambda)R$  is in  $P(q(V''), \gamma_{(V'', \delta'')})$ . We let  $\underline{X}^b := X_{i_1}^{e_{i_1, j_1}} \dots X_{i_{r+1}}^{e_{i_{r+1}, j_{r+1}}}$  be such a generator corresponding to an  $r$ -path  $P_r := v_{i_1, j_1} \cdots v_{i_{r+1}, j_{r+1}}$  in  $(\Sigma_{r-1}G)_\lambda$ . We need to show that  $\underline{X}^b \in P(q(V''), \gamma_{(V'', \delta'')})$ . Note that  $X_{i_1}^{e_{i_1, j_1}} \cdots X_{i_{r+1}}^{e_{i_{r+1}, j_{r+1}}}$  is of the following form. We replace each vertex in  $P_r$  with the corresponding variable and its exponent.

$$\begin{array}{c} X_{i_1+j_1, 0}^{e_{i_1+j_1, 0}} \\ \parallel \\ X_{i_1, 0}^{e_{i_1, 0}} \text{ --- } X_{i_1, 1}^{e_{i_1, 1}} \text{ --- } \cdots \text{ --- } X_{i_1, j_1}^{e_{i_1, j_1}} \\ | \\ \vdots \\ | \\ X_{i_{r+1}, 0}^{e_{i_{r+1}, 0}} \text{ --- } X_{i_{r+1}, 1}^{e_{i_{r+1}, 1}} \text{ --- } \cdots \text{ --- } X_{i_{r+1}, j_{r+1}}^{e_{i_{r+1}, j_{r+1}}} \\ \parallel \\ X_{i_1+r-j_{r+1}, 0}^{e_{i_1+r-j_{r+1}, 0}} \end{array}$$

where  $j_1$  or  $j_{r+1}$  may be 0. Since  $P_r$  is an  $r$ -path in  $(\Sigma_{r-1}G)_\lambda$  and  $(V'', \delta'')$  is a weighted  $r$ -path vertex cover of  $(\Sigma_{r-1}G)_\lambda$ , we have that  $v_{i_l, j_l}$  weighted-covers the  $r$ -path  $P_r$  for some  $l \in \{1, \dots, r+1\}$ . So  $v_{i_l, j_l} \in \text{WCA}_{i_l}(\mathfrak{P})$  and then

$$\gamma_{(V'', \delta'')}(v_{i_l}) = \min_{v_{i_l, t} \in \text{WCA}_{i_l}(\mathfrak{P})} \left\{ \delta''(v_{i_l, t}) + \sum_{k=0}^{t-1} h_{i_l, k} \right\} \leq \delta''(v_{i_l, j_l}) + \sum_{k=0}^{j_l-1} h_{i_l, k}.$$

Let  $M_0 := \max_{1 \leq k \leq r+1} \{j_k \mid i_l = i_k\}$ . Then  $j_l \leq M_0$ . Since  $v_{i_l, j_l}$  weighted-covers the  $r$ -path  $P_r$ ,  $\delta''(v_{i_l, j_l}) \leq e_{i_l, j_l}$ . So

$$\delta''(v_{i_l, j_l}) + \sum_{k=0}^{j_l-1} e_{i_l, k} \leq e_{i_l, j_l} + \sum_{k=0}^{j_l-1} e_{i_l, k} = \sum_{k=0}^{j_l} e_{i_l, k} \leq \sum_{k=0}^{M_0} e_{i_l, k}, \text{ i.e., } \delta''(v_{i_l, j_l}) + \sum_{k=0}^{j_l-1} e_{i_l, k} \leq \sum_{k=0}^{M_0} e_{i_l, k}.$$

(a) Assume that  $j_l = 0$ . Then

$$\gamma_{(V'', \delta'')}(v_{i_l}) \leq \delta''(v_{i_l, j_l}) + \sum_{k=0}^{j_l-1} h_{i_l, k} = \delta''(v_{i_l, j_l}) + \sum_{k=0}^{j_l-1} e_{i_l, k} \leq \sum_{k=0}^{M_0} e_{i_l, k} = \sum_{k=0}^{r+1} \mathbb{1}_{l, k} e_{i_k, j_k} = b_{i_l},$$

where  $\mathbb{1}_{l, k} = \begin{cases} 1 & \text{if } i_k = i_l \\ 0 & \text{otherwise} \end{cases}, \forall k = 1, \dots, r+1.$

(b) Assume that  $j_l > 0$ . Then  $M_0 \geq 1$ . Since  $\lambda(v_i v_j) \leq \min\{\lambda(v_i, v_{i,1}), \lambda(v_j, v_{j,1})\}$  for all edges  $v_i v_j \in E$ , we have that  $e_{i_0, 0} = \lambda(v_{i_0, 0} v_{i_0, 1}) = h_{i_0, 0}$ . Also, since  $e_{i_0, k} = h_{i_0, k}$  for  $k = 1, \dots, j_l - 1$ , we have that

$$\gamma_{(V'', \delta'')}(v_{i_l}) \leq \delta''(v_{i_l, j_l}) + \sum_{k=0}^{j_l-1} h_{i_l, k} = \delta''(v_{i_l, j_l}) + \sum_{k=0}^{j_l-1} e_{i_l, k} \leq \sum_{k=0}^{M_0} e_{i_l, k} = \sum_{k=0}^{r+1} \mathbb{1}_{l, k} e_{i_k, j_k} = b_{i_l}.$$

So  $X_{i_l}^{\gamma_{(V'', \delta'')}(v_{i_l})} \mid \underline{X}^b$ . Thus,  $\underline{X}^b \in P(q(V''), \gamma_{(V'', \delta'')})$ .  $\square$

**Proposition 4.2.5.** Let  $(\Sigma_{r-1}G)_\lambda$  be a weighted  $(r-1)$ -path suspension of  $G_\omega$  such that  $\lambda(v_i v_j) \leq \lambda(v_i, v_{i,1})$  and  $\lambda(v_i v_j) \leq \lambda(v_j, v_{j,1})$  for all  $v_i v_j \in E$ . The monomial ideal  $I_r((\Sigma_{r-1}G)_\lambda)R$  can be written as a finite intersection of m-irreducible ideals of the form  $P(q(V''), \gamma_{(V'', \delta'')})$  with  $V'' \subseteq V(\Sigma_{r-1}G)$  and  $\delta'' : V'' \rightarrow \mathbb{N}$ .

*Proof.* Fact 2.2.38 gives a decomposition of  $I_r((\Sigma_{r-1}G)_\lambda)R$ . Let  $J := (X_{b_1}^{\beta_{b_1}}, \dots, X_{b_s}^{\beta_{b_s}})R$  occur in the decomposition. Without loss of generality, assume that  $b_1, \dots, b_s \in \mathbb{N}$  are distinct, and let

$k \in \{1, \dots, s\}$ . By Fact 2.2.38, there exists a generator  $p(X_{i_1, j_1} \dots X_{i_{r+1}, j_{r+1}})$  with  $v_{i_1, j_1} \dots v_{i_{r+1}, j_{r+1}}$  an  $r$ -path in  $(\Sigma_{r-1}G)_\lambda$  such that for some  $c(k) \in \{1, \dots, r+1\}$ , we have that  $i_{c(k)} = b_k$  and

$$\beta_{b_k} = \begin{cases} e_{b_k, 0} & \text{if } M_k = 0, \\ \lambda(v_{b_k, M_k} v_{b_k, M_k-1}) + \sum_{l=0}^{M_k-1} h_{b_k, l} & \text{if } M_k \geq 1, \end{cases}$$

where  $M_k := \max_{1 \leq n \leq r+1} \{j_n \mid b_k = i_n\} \leq r-1$  and

$$e_{i_m, j_m} = \begin{cases} \lambda(v_{i_1, j_1} v_{i_2, j_2}) & \text{if } m = 1, \\ \max\{\lambda(v_{i_{m-1}, j_{m-1}} v_{i_m, j_m}), \lambda(v_{i_m, j_m} v_{i_{m+1}, j_{m+1}})\} & \text{if } m = 2, \dots, r, \\ \lambda(v_{i_r, j_r} v_{i_{r+1}, j_{r+1}}) & \text{if } m = r+1. \end{cases}$$

We repeat the process for each  $k \in \{1, \dots, s\}$  and set  $V'' = \{v_{b_1, M_1}, \dots, v_{b_s, M_s}\}$ . Then  $q(V'') = \{v_{b_1}, \dots, v_{b_s}\}$ . Define

$$\begin{aligned} \delta'' : V'' &\longrightarrow \mathbb{N} \\ v_{b_k, M_k} &\longmapsto \begin{cases} \lambda(v_{b_k, M_k} v_{b_k, M_k-1}) & \text{if } M_k \geq 1 \\ \beta_{b_k} (= e_{b_k, 0}) & \text{if } M_k = 0 \end{cases}, \forall k = 1, \dots, s. \end{aligned}$$

We claim  $J = P(q(V''), \gamma_{(V'', \delta'')})$ . It is enough to show  $\gamma_{(V'', \delta'')}(v_{b_k}) = \beta_{b_k}$  for  $k = 1, \dots, s$ . Let  $\mathfrak{P} := (V'', \delta'')$ . Since  $|V''| = |q(V'')|$ , we have  $|\text{WCA}_k(\mathfrak{P})| \leq 1$  for  $k = 1, \dots, s$ . There are two cases:

(a) Assume that  $M_k \geq 1$ . Since  $v_{b_k, M_k} \in V''$  and  $\delta''(v_{b_k, M_k}) = \lambda(v_{b_k, M_k} v_{b_k, M_k-1})$ , we have that  $v_{b_k, M_k} \in \text{WCA}_{b_k}(\mathfrak{P})$ . Therefore, we have that  $\text{WCA}_{b_k}(\mathfrak{P}) = \{v_{b_k, M_k}\}$ , and hence

$$\gamma_{(V'', \delta'')}(v_{b_k}) = \delta''(v_{b_k, M_k}) + \sum_{l=0}^{M_k-1} h_{b_k, l} = \lambda(v_{b_k, M_k} v_{b_k, M_k-1}) + \sum_{l=0}^{M_k-1} h_{b_k, l} = \beta_{b_k}.$$

(b) Assume that  $M_k = 0$ . Then  $j_{c(k)} \in \{0, \dots, M_k\} = \{0\}$  and so  $j_{c(k)} = 0$ . Then

$$e_{i_{c(k)}, j_{c(k)}} = \begin{cases} \lambda(v_{i_1, j_1} v_{i_2, j_2}) & \text{if } c(k) = 1, \\ \lambda(v_{i_r, j_r} v_{i_{r+1}, j_{r+1}}) & \text{if } c(k) = r+1, \\ \max\{\lambda(v_{i_{c(k)-1}, j_{c(k)-1}} v_{i_{c(k)}, j_{c(k)}}), \lambda(v_{i_{c(k)}, j_{c(k)}} v_{i_{c(k)+1}, j_{c(k)+1}})\} & \text{if } 2 \leq c(k) \leq r-1 \end{cases}$$

$\delta''(v_{i_c(k),j_c(k)}) = \delta''(v_{b_k,0}) = \beta_{b_k} = e_{b_k,0} = e_{i_c(k),j_c(k)}$ , and  $v_{i_c(k),M_k} = v_{b_k,0} = v_{b_k,M_k} \in V''$ . So  $v_{b_k,0} \in \text{WCA}_{b_k}(\mathfrak{A})$  and thus  $\text{WCA}_{b_k}(\mathfrak{A}) = \{v_{b_k,0}\}$ . Hence

$$\gamma_{(V'',\delta'')}(v_{b_k}) = \delta''(v_{b_k,0}) + \sum_{l=0}^{0-1} h_{b_k,l} = \delta''(v_{b_k,0}) = \beta_{b_k}. \quad \square$$

**Example 4.2.6.** Consider the following graph  $(\Sigma_2 P_1)_\lambda$  from Example 4.2.3.

$$\begin{array}{ccccc} v_1 & \xrightarrow{2} & v_{1,1} & \xrightarrow{5} & v_{1,2} \\ | & & & & \\ v_2 & \xrightarrow{3} & v_{2,1} & \xrightarrow{4} & v_{2,2} \end{array}$$

By Example 4.2.3,  $I_3((\Sigma_2 P_1))R = (X_1^{12}X_2^2, X_1^4X_2^6, X_1^2X_2^{11})R$ . By Fact 2.2.38,

$$\begin{aligned} I_3((\Sigma_2 P_1))R &= (X_1^{12}, X_1^4, X_1^2)R \cap (X_1^{12}, X_1^4, X_2^{11})R \cap (X_1^{12}, X_2^6, X_2^2)R \cap (X_1^{12}, X_2^6, X_2^{11})R \\ &\quad \cap (X_2^2, X_1^4, X_1^2)R \cap (X_2^2, X_1^4, X_2^{11})R \cap (X_2^2, X_2^6, X_1^2)R \cap (X_2^2, X_2^6, X_2^{11})R \\ &= (X_1^2)R \cap (X_1^4, X_2^{11})R \cap (X_1^2, X_2^6)R \cap (X_1^{12}, X_2^6)R \\ &\quad \cap (X_1^2, X_2^2)R \cap (X_1^4, X_2^2)R \cap (X_1^2, X_2^2)R \cap (X_2^2)R. \end{aligned}$$

Let  $J_1 = (X_1^2)R$ . Then  $b_1 = 1$  and  $\beta_{b_1} = \beta_1 = 2$ . Consider the generator  $X_{1,0}^{e_{1,0}} X_{2,0}^{e_{2,0}} X_{2,1}^{e_{2,1}} X_{2,2}^{e_{2,2}} := X_1^2 X_2^3 X_{2,1}^4 X_{2,2}^4$  of  $I_3((\Sigma_2 P_1)_\lambda)$ . Then  $M_1 := 0$  and  $\beta_1 = e_{1,0} = 2$ . Let  $V'' = \{v_{1,0}\}$  and  $\delta'' : V'' \rightarrow \mathbb{N}$  be given by  $v_1 \mapsto e_{1,0} = 2$ . Since  $q(V'') = \{v_1\}$ ,  $\gamma_{(V'',\delta'')}(v_1) = \delta''(v_{1,0}) = 2$ . So we have that

$$P(q(V''), \gamma_{(V'',\delta'')}) = P(\{v_1^2\}) = (X_1^2)R = J_1.$$

Let  $J_2 = (X_1^4, X_2^{11})R$ . Then  $b_1 = 1, b_2 = 2$ , and  $\beta_{b_1} = \beta_1 = 4$  and  $\beta_{b_2} = \beta_2 = 11$ . Consider the generator  $X_{1,1}^{e_{1,1}} X_{1,0}^{e_{1,0}} X_{2,0}^{e_{2,0}} X_{2,1}^{e_{2,1}} := X_{11}^2 X_1^2 X_2^3 X_{2,1}^3$  of  $I_3((\Sigma_2 P_1)_\lambda)$ . Then  $M_1 := 1$  and  $\beta_1 = \lambda(v_{1,1}v_{1,0}) + h_{1,0} = 2 + 2 = 4$ . Consider the generator  $X_{1,0}^{e_{1,0}} X_{2,0}^{e_{2,0}} X_{2,1}^{e_{2,1}} X_{2,2}^{e_{2,2}} := X_1^2 X_2^3 X_{2,1}^4 X_{2,2}^4$  of  $I_3((\Sigma_2 P_1)_\lambda)$ . Then  $M_2 := 2$  and  $\beta_2 = \lambda(v_{2,2}v_{2,1}) + h_{2,0} + h_{2,1} = 4 + 3 + 4 = 11$ . Let  $V'' = \{v_{1,1}, v_{2,2}\}$  and  $\delta'' : V'' \rightarrow \mathbb{N}$  be given by  $v_1 \mapsto \lambda(v_{1,1}v_{1,0}) = 2$  and  $v_{2,2} \mapsto \lambda(v_{2,2}v_{2,1}) = 4$ . Then  $q(V'') = \{v_1, v_2\}$  and so  $\gamma_{(V'',\delta'')}(v_1) = \delta''(v_{1,1}) + h_{1,0} = 2 + 2$  and

$$\gamma_{(V'',\delta'')}(v_2) = \delta''(v_{2,2}) + h_{2,0} + h_{2,1} = 4 + 3 + 4 = 11.$$



So we have that

$$P(q(V''), \gamma(V'', \delta'')) = P(\{v_1^4, v_2^{11}\}) = (X_1^4, X_2^{11})R = J_2.$$

The next result is our first decomposition needed for computing  $r_{R'}(R'/I_r((\Sigma_r G)_\lambda))$ .

**Theorem 4.2.7.** *Let  $(\Sigma_r G)_\lambda$  be a weighted  $r$ -path suspension of  $G_\omega$  such that  $\lambda(v_i v_j) \leq \lambda(v_i v_{i,1})$  and  $\lambda(v_i v_j) \leq \lambda(v_j v_{j,1})$  for all edges  $v_i v_j \in E$ . We have*

$$I_r((\Sigma_{r-1} G)_{\lambda'})R = \bigcap_{(V'', \delta'') \text{ w. } r\text{-path v. cover of } (\Sigma_{r-1} G)_{\lambda'}} P(q(V''), \gamma(V'', \delta'')), \text{ where } \lambda' = \lambda|_{\Sigma_{r-1} G},$$

and

$$I_r((\Sigma_r G)_\lambda)R = \bigcap_{(V'', \delta'') \text{ w. } r\text{-path v. cover of } (\Sigma_{r-1} G)_{\lambda'}} P(q(V''), \gamma(V'', \delta'')) + \mathfrak{m}^{[\underline{a}(\lambda)]}.$$

*Proof.* Note that  $I_r((\Sigma_r G)_\lambda)R = I_r((\Sigma_{r-1} G)_{\lambda'})R + \mathfrak{m}^{[\underline{a}(\lambda)]}$  by Fact 4.1.7. Then it is enough to show that, by [9, Theorem 7.5.3],

$$I_r((\Sigma_{r-1} G)_{\lambda'})R = \bigcap_{(V'', \delta'') \text{ w. } r\text{-path v. cover of } (\Sigma_{r-1} G)_{\lambda'}} P(q(V''), \gamma(V'', \delta'')).$$

By Proposition 4.2.5, the monomial ideal  $I_r((\Sigma_{r-1} G)_{\lambda'})R$  can be written as a finite intersection of  $\mathfrak{m}$ -irreducible ideals of the form  $P(q(V'') := \{v_{i_1}, \dots, v_{i_t}\}, \gamma(V'', \delta''))$  with  $V'' \subseteq V(\Sigma_{r-1} G)$  and  $\delta'' : V'' \rightarrow \mathbb{N}$ . Then by Theorem 4.2.4,

$$\begin{aligned} I_r((\Sigma_{r-1} G)_{\lambda'})R &\subseteq \bigcap_{(V'', \delta'') \text{ w. } r\text{-path v. cover of } (\Sigma_{r-1} G)_{\lambda'}} P(q(V''), \gamma(V'', \delta'')) \\ &\subseteq \bigcap_{(V'', \delta'') \text{ w. } r\text{-path v. cover of } (\Sigma_{r-1} G)_{\lambda'} \text{ in the decomp. of } I_r((\Sigma_{r-1} G)_{\lambda'})R} P(q(V''), \gamma(V'', \delta'')) \\ &= I_r((\Sigma_{r-1} G)_{\lambda'})R. \end{aligned}$$

So we have that

$$I_r((\Sigma_{r-1} G)_{\lambda'})R = \bigcap_{(V'', \delta'') \text{ w. } r\text{-path v. cover of } (\Sigma_{r-1} G)_{\lambda'}} P(q(V''), \gamma(V'', \delta'')). \quad \square$$

**Example 4.2.8.** Consider the following weighted 3-path suspension  $(\Sigma_3 P_1)_\lambda$  of  $G_\omega := (P_1)_\omega =$

$$(v_1 \xrightarrow{2} v_2).$$

$$\begin{array}{ccccccc} v_1 & \xrightarrow{2} & v_{1,1} & \xrightarrow{5} & v_{1,2} & \xrightarrow{2} & v_{1,3} \\ 2 & \Big| & & & & & \\ v_2 & \xrightarrow{3} & v_{2,1} & \xrightarrow{4} & v_{2,2} & \xrightarrow{2} & v_{2,3} \end{array}$$

Let  $\lambda' = \lambda|_{\Sigma_2 P_1}$ . Since  $I_3((\Sigma_2 P_1)_{\lambda'}) = (X_{1,2}^5 X_{1,1}^5 X_1^2 X_2^2, X_{1,1}^2 X_1^2 X_2^3 X_{2,1}^3, X_1^2 X_2^3 X_{2,1}^4 X_{2,2}^4)$ , by Theorem 4.2.7, we have two infinite intersections:

$$I_3((\Sigma_2 P_1)_{\lambda'})R = (X_1^{12} X_2^2, X_1^4 X_2^6, X_1^2 X_2^{11})R = \bigcap_{(V'', \delta'') \text{ w. } r\text{-path v. cover of } (\Sigma_2 P_1)_{\lambda'}} P(q(V''), \gamma_{(V'', \delta'')}),$$

and

$$\begin{aligned} I_3((\Sigma_3 P_1)_{\lambda'})R &= (X_1^{12} X_2^2, X_1^4 X_2^6, X_1^2 X_2^{11})R + (X_1^{14}, X_2^{13})R \\ &= \bigcap_{(V'', \delta'') \text{ w. } r\text{-path v. cover of } (\Sigma_2 P_1)_{\lambda'}} P(q(V''), \gamma_{(V'', \delta'')}). \end{aligned}$$

The next result is key for our second decomposition result, Corollary 4.2.11.

**Lemma 4.2.9.** Let  $\mathfrak{p} := (V_1'', \delta_1'')$ ,  $\mathfrak{P} := (V_2'', \delta_2'')$  be such that  $V_1'', V_2'' \subseteq V((\Sigma_{r-1} G)_\lambda)$  and  $\delta_1'', \delta_2'' : V'' \rightarrow \mathbb{N}$ . If  $(V_1'', \delta_1'') \leq (V_2'', \delta_2'')$ , then  $P(q(V_1''), \gamma_{(V_1'', \delta_1'')}) \subseteq P(q(V_2''), \gamma_{(V_2'', \delta_2'')})$ .

*Proof.* Let  $X_i^{\gamma_{(V_1'', \delta_1'')}(v_i)}$  be a generator of  $P(q(V_1''), \gamma_{(V_1'', \delta_1'')})$ . Then  $V_1'' \subseteq V_2''$  implies we have that  $X_i^{\gamma_{(V_2'', \delta_2'')}(v_i)} \in P(q(V_2''), \gamma_{(V_2'', \delta_2'')})$  and

$$\begin{aligned} \gamma_{(V_1'', \delta_1'')}(v_i) &= \min \left\{ \delta_1''(v_{i,j,t}) + \sum_{k=0}^{t-1} h_{i,j,k} \mid v_{i,j,t} \in \text{WCA}_{i_j}(\mathfrak{p}) \right\} \\ &\geq \min \left\{ \delta_2''(v_{i,j,t}) + \sum_{k=0}^{t-1} h_{i,j,k} \mid v_{i,j,t} \in \text{WCA}_{i_j}(\mathfrak{P}) \right\} = \gamma_{(V_2'', \delta_2'')}(v_i). \end{aligned}$$

It follows that  $X_i^{\gamma_{(V_2'', \delta_2'')}(v_i)} \mid X_i^{\gamma_{(V_1'', \delta_1'')}(v_i)}$ , and hence  $P(q(V_1''), \gamma_{(V_1'', \delta_1'')}) \subseteq P(q(V_2''), \gamma_{(V_2'', \delta_2'')})$ .  $\square$

**Example 4.2.10.** Consider the following two pairs of sets  $\mathfrak{p} := (V_1'', \delta_1'') := \{v_{1,1}^4, v_2^5, v_{2,1}^6\}$  and  $\mathfrak{P} := (V_2'', \delta_2'') := \{v_{1,1}^3, v_{1,2}^5, v_2^5, v_{2,1}^3\}$  of  $(\Sigma_2 P_1)_\lambda$  from Example 4.2.3.

$$\begin{array}{ccc} v_1 & \xrightarrow{2} & \textcircled{v_{1,1}^4} & \xrightarrow{5} & v_{1,2} \\ 2 & \Big| & & & \\ \textcircled{v_2^5} & \xrightarrow{3} & \textcircled{v_{2,1}^6} & \xrightarrow{4} & v_{2,2} \end{array} \qquad \begin{array}{ccc} v_1 & \xrightarrow{2} & \textcircled{v_{1,1}^3} & \xrightarrow{5} & \textcircled{v_{1,2}^6} \\ 2 & \Big| & & & \\ \textcircled{v_2^5} & \xrightarrow{3} & \textcircled{v_{2,1}^3} & \xrightarrow{4} & v_{2,2} \end{array}$$

Since  $V_1'' \subseteq V_2''$  and  $\delta_1'' \geq \delta_2''|_{V_1''}$ , we have that  $(V_1'', \delta_1'') \leq (V_2'', \delta_2'')$ . Similar to Example 4.2.3, we have that  $\text{WCA}_1(\mathbf{p}) = \{v_{1,1}\}$  and  $\text{WCA}_2(\mathbf{p}) = \emptyset$ . Therefore,  $\gamma_{(V_1'', \delta_1'')}(v_2) = \infty$  and

$$\gamma_{(V_1'', \delta_1'')}(v_1) = \delta_1''(v_{1,1}) + \sum_{k=0}^{1-1} h_{1,k} = \delta_1''(v_{1,1}) + \max\{\lambda(v_1 v_2), \lambda(v_1 v_{1,1})\} = 4 + \max\{2, 2\} = 5.$$

Also, since  $q(V_1'') = \{v_1, v_2\}$ , we have that  $P(q(V_1''), \gamma_{(V_1'', \delta_1'')}) = (X_1^5, X_2^\infty)R = (X_1^5)R$ . Then from Example 4.2.3, we have that

$$P(q(V_2''), \gamma_{(V_2'', \delta_2'')}) = (X_1^5, X_2^6)R \supseteq (X_1^5)R = P(q(V_1''), \gamma_{(V_1'', \delta_1'')}).$$

Here is our second decomposition result for computing  $\text{r}_{R'}(R'/I_r((\Sigma_r G)_\lambda))$ .

**Corollary 4.2.11.** Let  $(\Sigma_r G)_\lambda$  be a weighted  $r$ -path suspension of  $G_\omega$  such that  $\lambda(v_i v_j) \leq \lambda(v_i, v_{i,1})$  and  $\lambda(v_i v_j) \leq \lambda(v_j, v_{j,1})$  for all edges  $v_i v_j \in E$ . We have

$$I_r((\Sigma_{r-1} G)_{\lambda'})R = \bigcap_{(V'', \delta'') \text{ min. w. } r\text{-path v. cover of } (\Sigma_{r-1} G)_{\lambda'}} P(q(V''), \gamma_{(V'', \delta'')}), \text{ where } \lambda' = \lambda|_{\Sigma_{r-1} G},$$

and

$$I_r((\Sigma_r G)_\lambda)R = \bigcap_{(V'', \delta'') \text{ min. w. } r\text{-path v. cover of } (\Sigma_{r-1} G)_{\lambda'}} P(q(V''), \gamma_{(V'', \delta'')}) + \mathbf{m}^{\lfloor \underline{a}(\lambda) \rfloor}.$$

*Proof.* By Fact 4.1.7 and [9, Theorem 7.5.3], it is enough to prove that

$$I_r((\Sigma_{r-1} G)_{\lambda'})R = \bigcap_{(V'', \delta'') \text{ min. w. } r\text{-path v. cover of } (\Sigma_{r-1} G)_{\lambda'}} P(q(V''), \gamma_{(V'', \delta'')}).$$

By Theorem 4.2.7, it is enough to show that

$$\begin{aligned} & \bigcap_{(V'', \delta'') \text{ weighted } r\text{-path v. cover of } (\Sigma_{r-1} G)_{\lambda'}} P(q(V''), \gamma_{(V'', \delta'')}) \\ &= \bigcap_{(V'', \delta'') \text{ min. weighted } r\text{-path v. cover of } (\Sigma_{r-1} G)_{\lambda'}} P(q(V''), \gamma_{(V'', \delta'')}). \end{aligned}$$

$\subseteq$  follows because every minimal weighted  $r$ -path vertex cover is a weighted  $r$ -path vertex cover.

$\supseteq$  follows from Fact 3.1.6 and Lemma 4.2.9.  $\square$

**Example 4.2.12.** Consider the following weighted 3-path suspension  $(\Sigma_3 P_1)_\lambda$  of  $G_\omega := (P_1)_\omega = (v_1 \xrightarrow{2} v_2)$ .

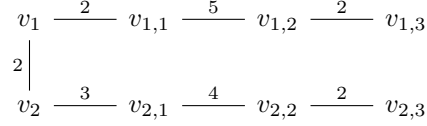

We depict the minimal weighted 3-path vertex covers of  $(\Sigma_2 P_1)_{\lambda'}$  with  $\lambda' = \lambda|_{\Sigma_2 P_1}$  in the following sketches:

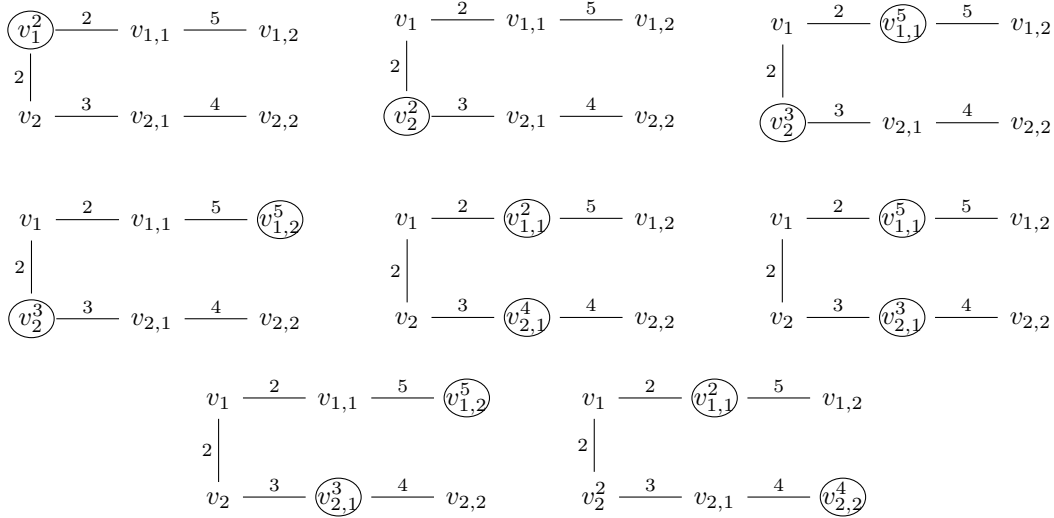

Since  $I_3((\Sigma_2 P_1)_{\lambda'}) = (X_{1,2}^5 X_{1,1}^5 X_1^2 X_2^2, X_{1,1}^2 X_1^2 X_2^3 X_{2,1}^3, X_1^2 X_2^3 X_{2,1}^4 X_{2,2}^4)$ , by Corollary 4.2.11, we have that

$$\begin{aligned} I_3((\Sigma_2 P_1)_{\lambda'})R &= (X_1^{12} X_2^2, X_1^4 X_2^6, X_1^2 X_2^{11})R = (X_1^2)R \cap (X_2^2)R \cap (X_1^7, X_2^3)R \cap (X_1^{12}, X_2^3)R \\ &\quad \cap (X_1^4, X_2^7) \cap (X_1^7, X_2^6) \cap (X_1^{12}, X_2^6)R \cap (X_1^4, X_2^{11})R. \end{aligned}$$

This decomposition is redundant. Thus, the decomposition in Corollary 4.2.11 may be redundant.

In light of the preceding example, we define another order from which we can produce an irredundant decomposition. Lemma 4.2.21 is the key for understanding how this ordering helps with irredundancy.

**Definition 4.2.13.** Given minimal weighted  $r$ -path vertex covers  $(V_1'', \delta_1'')$ ,  $(V_2'', \delta_2'')$  of  $(\Sigma_{r-1} G)_\lambda$ , we write  $(V_1'', \delta_1'') \leq_\rho (V_2'', \delta_2'')$  if  $q(V_1'') \subseteq q(V_2'')$  and  $\gamma_{(V_1'', \delta_1'')} \geq \gamma_{(V_2'', \delta_2'')}|_{q(V_1'')}$ . A minimal weighted

$r$ -path vertex cover  $(V'', \delta'')$  is  $\mathcal{P}$ -minimal if there is not another minimal weighted  $r$ -path vertex cover  $(V''', \delta''')$  such that  $(V'', \delta'') <_{\mathcal{P}} (V''', \delta''')$ .

**Example 4.2.14.** Consider the following two minimal weighted 3-path vertex covers  $(V_1'', \delta_1'') := \{v_{1,2}^5, v_2^3\}$  and  $(V_2'', \delta_2'') := \{v_{1,2}^5, v_{2,1}^3\}$  of  $(\Sigma_2 P_1)_\lambda$  from Example 4.2.12.

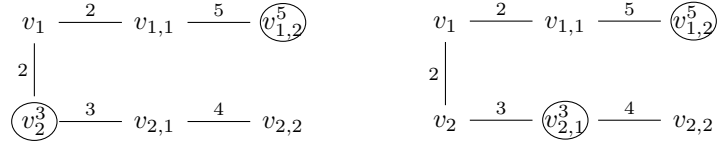

Then  $q(V_1'') = \{v_1, v_2\} = q(V_2'')$ . Since

$$\gamma_{(V_1'', \delta_1'')}(v_1) = \delta_1''(v_{1,2}) + h_{1,1} + h_{1,0} = 5 + 5 + 2 = \delta_2''(v_{1,2}) + h_{1,1} + h_{1,0} = \gamma_{(V_2'', \delta_2'')}(v_1),$$

and  $\gamma_{(V_1'', \delta_1'')}(v_2) = \delta_1''(v_2) = 3 < 3 + 3 = \delta_2''(v_{2,1}) + h_{2,0} = \gamma_{(V_2'', \delta_2'')}(v_2)$ , we have that  $\gamma_{(V_1'', \delta_1'')} < \gamma_{(V_2'', \delta_2'')}$ . So  $(V_1'', \delta_1'') >_{\mathcal{P}} (V_2'', \delta_2'')$ . Hence  $(V_1'', \delta_1'')$  is not  $\mathcal{P}$ -minimal.

**Lemma 4.2.15.** Let  $\mathfrak{p} := (W', \delta')$  and  $\mathfrak{P} := (W'', \delta'')$  be two minimal weighted  $r$ -path vertex covers of  $(\Sigma_{r-1} G)_\lambda$  such that  $(W'', \delta'') \leq_{\mathcal{P}} (W', \delta')$ , then  $|(W'', \delta'')| = |(W', \delta')|$  and  $q(W'') = q(W')$ .

*Proof.* Since  $(W', \delta')$  is a minimal weighted  $r$ -path vertex cover of  $(\Sigma_{r-1} G)_\lambda$ , for a distinct pair  $v_{i_1, j_1}, v_{i_2, j_2} \in W'$ , we have that  $i_1 \neq i_2$ . Also, since  $q(W'') \subseteq q(W')$ ,  $|W''| = |q(W'')| \leq |q(W')| = |W'|$ . Suppose that  $|W''| < |W'|$ . Then there exists  $v_{i,j} \in W'$  such that  $v_i \notin q(W'')$ . Since  $(W', \delta')$  is a minimal weighted  $r$ -path vertex cover of  $(\Sigma_{r-1} G)_\lambda$ , there is an  $r$ -path  $P_r$  in  $(\Sigma_{r-1} G)_\lambda$  that can only be weighted-covered by  $v_{i,j}$ . By assumption,  $P_r$  can be weighted-covered by some  $v_{k,l} \in W''$ , so  $v_k \in q(W'')$ . Also, since  $v_i \notin q(W'')$ , we have that  $k \neq i$ . Let  $\alpha = \min\{b \mid v_{k,b} \in \text{WCA}_k(\mathfrak{p})\}$  and  $\beta = \min\{b \mid v_{k,b} \in \text{WCA}_k(\mathfrak{P})\}$ . So we have that  $\alpha, \beta \leq l$ . Since  $\gamma_{(W'', \delta'')} \geq \gamma_{(W', \delta')}$ , we have that  $\alpha \leq \beta$  similar to the proof of Proposition 4.2.2. If  $\alpha < l$ , then it is straightforward to show that  $P_r$  can also be weighted-covered by  $v_{k,\alpha} \in W'$ , a contradiction. Assume that  $\alpha = l$ . Then  $\alpha = \beta = l$  and so  $v_{k,\beta} \in W''$  weighted-cover  $P_r$ . Since

$$\delta''(v_{k,\alpha}) + \sum_{b=0}^{\alpha-1} h_{k,b} = \gamma_{(W'', \delta'')}(v_k) \geq \gamma_{(W', \delta')}(v_k) = \delta'(v_{k,\alpha}) + \sum_{b=0}^{\alpha-1} h_{k,b},$$

we have that  $\delta'(v_{k,\alpha}) \leq \delta''(v_{k,\alpha})$ . So  $P_r$  can also be weighted-covered by  $v_{k,\alpha} \in W'$ , a contradiction.

Hence  $|W''| = |W'|$  and thus  $|q(W'')| = |q(W')|$ . Since  $q(W'') \subseteq q(W')$ , we have that  $q(W'') = q(W')$ .  $\square$

**Example 4.2.16.** Consider the minimal weighted 3-path vertex covers  $(V_1'', \delta_1'') := \{v_{1,2}^5, v_2^3\}$  and  $(V_2'', \delta_2'') := \{v_{1,2}^5, v_{2,1}^3\}$  of  $(\Sigma_2 P_1)_\lambda$  from Example 4.2.18(a).

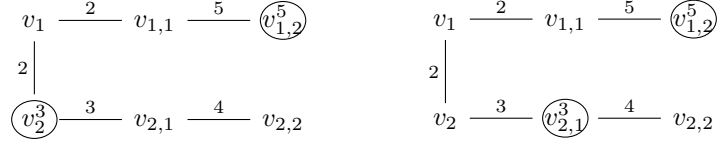

By Example 4.2.18(a),  $(V_1'', \delta_1'') <_{\mathcal{P}} (V_2'', \delta_2'')$ . Then  $|(V_1'', \delta_1'')| = |\{v_{1,2}, v_2\}| = 2 = |\{v_{1,2}, v_{2,1}\}| = |(V_2'', \delta_2'')|$  and  $q(V_1'') = \{v_1, v_2\} = q(V_2'')$ .

The following theorem can be used as an algorithm to find the set of  $\mathcal{P}$ -minimal weighted  $r$ -path vertex covers of  $(\Sigma_{r-1} G)_\lambda$  from the set of minimal weighted  $r$ -path vertex covers.

**Theorem 4.2.17.** Let  $\mathfrak{p} := (V_1'', \delta_1'')$ ,  $\mathfrak{P} := (V_2'', \delta_2'')$  be two minimal weighted  $r$ -path vertex covers of  $(\Sigma_{r-1} G)_\lambda$ . Then  $(V_1'', \delta_1'') \leq_{\mathcal{P}} (V_2'', \delta_2'')$  if and only if  $q(V_1'') = q(V_2'')$  and for any  $v_{i_l} \in q(V_1'')$ :  $j_{1,l} > j_{2,l}$  or  $j_{1,l} = j_{2,l}$  and  $\delta_1''(v_{i_l, j_{1,l}}) \geq \delta_2''(v_{i_l, j_{2,l}})$  with  $j_{1,l} := \{j \mid v_{i_l, j} \in V_1''\}$  and  $j_{2,l} := \{j \mid v_{i_l, j} \in V_2''\}$ .

*Proof.* By Lemma 4.2.15,  $(V_1'', \delta_1'') \leq_{\mathcal{P}} (V_2'', \delta_2'')$  if and only if  $q(V_1'') = q(V_2'')$  and  $\gamma_{(V_1'', \delta_1'')}|_{q(V_1'')} \geq \gamma_{(V_2'', \delta_2'')}|_{q(V_1'')}$  if and only if  $q(V_1'') = q(V_2'')$  and for any  $v_{i_l} \in q(V_1'')$ ,  $\gamma_{(V_1'', \delta_1'')}(v_{i_l}) \geq \gamma_{(V_2'', \delta_2'')}(v_{i_l})$  if and only if  $q(V_1'') = q(V_2'')$  and for any  $v_{i_l} \in q(V_1'')$ ,  $\delta_1''(v_{i_l, j_{1,l}}) + \sum_{k=0}^{j_{1,l}-1} h_{i_l, k} \geq \delta_2''(v_{i_l, j_{2,l}}) + \sum_{k=0}^{j_{2,l}-1} h_{i_l, k}$  by Proposition 4.2.2. We claim that for  $v_{i_l} \in q(V_1'')$ ,  $\delta_1''(v_{i_l, j_{1,l}}) + \sum_{k=0}^{j_{1,l}-1} h_{i_l, k} \geq \delta_2''(v_{i_l, j_{2,l}}) + \sum_{k=0}^{j_{2,l}-1} h_{i_l, k}$  if and only if  $j_{1,l} > j_{2,l}$ , or  $j_{1,l} = j_{2,l}$  and  $\delta_1''(v_{i_l, j_{1,l}}) \geq \delta_2''(v_{i_l, j_{2,l}})$ .

$\Leftarrow$  Assume that  $j_{1,l} > j_{2,l}$ , or  $j_{1,l} = j_{2,l}$  and  $\delta_1''(v_{i_l, j_{1,l}}) \geq \delta_2''(v_{i_l, j_{2,l}})$ . Then

$$\alpha := \left( \delta_1''(v_{i_l, j_{1,l}}) + \sum_{k=0}^{j_{1,l}-1} h_{i_l, k} \right) - \left( \delta_2''(v_{i_l, j_{2,l}}) + \sum_{k=0}^{j_{2,l}-1} h_{i_l, k} \right) = \delta_1''(v_{i_l, j_{1,l}}) - \delta_2''(v_{i_l, j_{2,l}}) + \sum_{k=j_{2,l}}^{j_{1,l}-1} h_{i_l, k}.$$

To prove our statement, it is equivalent to show that  $\alpha \geq 0$ .

(a) If  $j_{1,l} > j_{2,l}$ , then  $\alpha \geq \delta_1''(v_{i_l, j_{1,l}}) - \delta_2''(v_{i_l, j_{2,l}}) + h_{i_l, j_{2,l}} > h_{i_l, j_{2,l}} - \delta_2''(v_{i_l, j_{2,l}}) \geq 0$ .

(b) If  $j_{1,l} = j_{2,l}$  and  $\delta_1''(v_{i_l, j_{1,l}}) \geq \delta_2''(v_{i_l, j_{2,l}})$ , then  $\alpha = \delta_1''(v_{i_l, j_{1,l}}) - \delta_2''(v_{i_l, j_{2,l}}) \geq 0$ .

$\implies$  Suppose that  $j_{1,l} < j_{2,l}$ , or  $j_{1,l} = j_{2,l}$  and  $\delta_1''(v_{i,j_{1,l}}) < \delta_2''(v_{i,j_{2,l}})$ . Then

$$\alpha := \left( \delta_1''(v_{i,j_{1,l}}) + \sum_{k=0}^{j_{1,l}-1} h_{i,k} \right) - \left( \delta_2''(v_{i,j_{2,l}}) + \sum_{k=0}^{j_{2,l}-1} h_{i,k} \right) = \delta_1''(v_{i,j_{1,l}}) - \delta_2''(v_{i,j_{2,l}}) - \sum_{k=j_{1,l}}^{j_{2,l}-1} h_{i,k}.$$

To prove our statement, it is equivalent to show that  $\alpha < 0$ .

(a) If  $j_{1,l} = j_{2,l}$  and  $\delta_1''(v_{i,j_{1,l}}) < \delta_2''(v_{i,j_{2,l}})$ , then  $\alpha = \delta_1''(v_{i,j_{1,l}}) - \delta_2''(v_{i,j_{2,l}}) < 0$ .

(b) If  $j_{1,l} < j_{2,l}$ , since  $v_{i,j_{1,l}} \in V_1''$  and  $V_1''$  is a minimal weighted  $r$ -path vertex cover, we have  $\delta_1''(v_{i,j_{1,l}}) \leq h_{i,j_{1,l}}$ , so  $\alpha = \delta_1''(v_{i,j_{1,l}}) - \delta_2''(v_{i,j_{2,l}}) - \sum_{k=j_{1,l}}^{j_{2,l}-1} h_{i,k} < \delta_1''(v_{i,j_{1,l}}) - h_{i,j_{1,l}} \leq 0$ .  $\square$

**Example 4.2.18.** We have the following examples:

(a) Consider the following two minimal weighted 3-path vertex covers  $(V_1'', \delta_1'') := \{v_{1,2}^5, v_2^3\}$  and  $(V_2'', \delta_2'') := \{v_{1,2}^5, v_{2,1}^3\}$  of  $(\Sigma_2 P_1)_\lambda$  from Example 4.2.14.

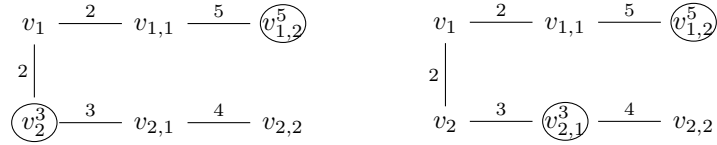

Then  $q(V_1'') = \{v_{i_1} := v_1, v_{i_2} := v_2\} = q(V_2'')$ . Note that

$$j_{1,1} = \min\{j \mid v_{i_1,j} \in V_1''\} = \min\{j \mid v_{1,j} \in V_1''\} = 2,$$

$$j_{1,2} = \min\{j \mid v_{i_2,j} \in V_1''\} = \min\{j \mid v_{2,j} \in V_1''\} = 0,$$

$$j_{2,1} = \min\{j \mid v_{i_1,j} \in V_2''\} = \min\{j \mid v_{2,j} \in V_2''\} = 2,$$

$$j_{2,2} = \min\{j \mid v_{i_2,j} \in V_2''\} = \min\{j \mid v_{2,j} \in V_2''\} = 1.$$

Since  $j_{1,1} = 2 = j_{2,1}$  and  $\delta_1''(v_{1,j_{1,1}}) = \delta_1''(v_{1,2}) = 5 = \delta_2''(v_{1,2}) = \delta_2''(v_{1,j_{2,1}})$ , and  $j_{1,2} = 0 < 1 = j_{2,2}$ , we have that  $(V_1'', \delta_1'') <_{\rho} (V_2'', \delta_2'')$  by Theorem 4.2.17.

(b) Consider all the minimal weighted 3-path vertex covers of  $(\Sigma_2 P_1)_\lambda$  from Example 4.2.12. Applying Theorem 4.2.17 repeatedly, we get all the  $\rho$ -minimal weighted 3-path vertex covers depicted

in the following.

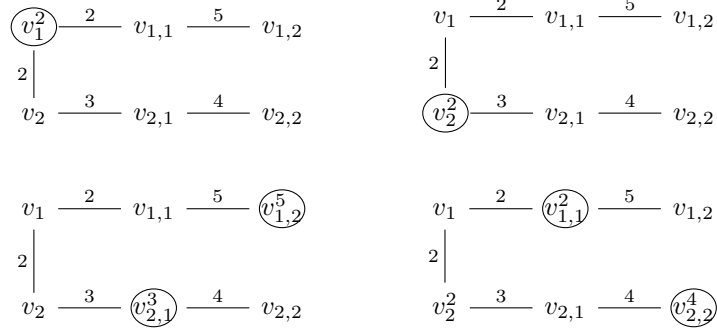

The next two results are key for our third and final decomposition result.

**Proposition 4.2.19.** For every minimal weighted  $r$ -path vertex cover  $\mathfrak{p} := (W', \delta')$  of  $(\Sigma_{r-1}G)_\lambda$ , there is a  $\mathfrak{p}$ -minimal weighted  $r$ -path vertex cover  $(W'', \delta'')$  of  $(\Sigma_{r-1}G)_\lambda$  such that  $(W'', \delta'') \leq_{\mathfrak{p}} (W', \delta')$ .

*Proof.* If  $(W', \delta')$  is itself a  $\mathfrak{p}$ -minimal weighted  $r$ -path vertex cover for  $(\Sigma_{r-1}G)_\lambda$ , then we are done. If  $(W', \delta')$  is not  $\mathfrak{p}$ -minimal, then by Lemma 4.2.15, the size of  $q(W')$  cannot be decreased, so for some  $v_i \in q(W')$  the function  $\gamma_{(W', \delta')}(v_i) = \delta'(v_{i,j_0}) + \sum_{k=0}^{j_0-1} h_{i,k}$  with  $j_0 := \{j \mid v_{i,j} \in \text{WCA}_i(\mathfrak{p})\}$  from Proposition 4.2.2 can be increased, which is done by increasing  $j_0$  and assigning an appropriate value to  $\delta'(v_{i,j_0})$  since  $(W', \delta')$  is minimal. We increase  $\gamma_{(W', \delta')}(v_i)$  for each  $v_i \in q(W')$  such that any further increase would cause the set not to be a weighted  $r$ -path vertex cover. This process terminates in finitely many steps because  $j_0 \leq r$ . Denote the new set  $(W'', \delta'')$ . Then  $(W'', \delta'')$  is minimal since the size of  $W''$  cannot be decreased by Lemma 4.2.15 and  $\delta''$  cannot be increased. Thus, by construction,  $(W'', \delta'')$  is a  $\mathfrak{p}$ -minimal weighted  $r$ -path vertex cover for  $(\Sigma_{r-1}G)_\lambda$  such that  $(W'', \delta'') \leq_{\mathfrak{p}} (W', \delta')$ .  $\square$

**Example 4.2.20.** Consider the following minimal weighted 3-path vertex cover  $\mathfrak{p} := (V_1'', \delta_1'') := \{v_{1,2}^5, v_2^3\}$  of  $(\Sigma_2 P_1)_\lambda$  from Example 4.2.18(a).

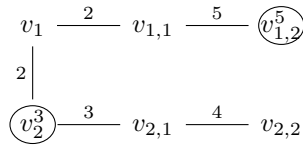

Note that  $\gamma_{(V_1'', \delta_1'')}(v_1)$  cannot be increased. Assume that  $v_{2,1} \in V''$ . Then setting  $\delta''(v_{2,1}) = 3$ ,



we have that  $\mathbf{p}' := (V_1''', \delta_1''') = \{v_{1,2}^5, v_{2,1}^3\}$  is a minimal weighted 3-path vertex cover by Example 4.2.18(a). However, since  $v_{1,2} \in V''$ , we have that  $v_{2,2}$  cannot be used to replace  $v_{2,1}$  in  $V_1'''$  to generate a minimal 3-path vertex cover, otherwise, the 3-path  $v_{1,1}v_1v_2v_{2,1}$  will be left uncovered. Thus,  $(V_1''', \delta_1''')$  is  $\rho$ -minimal and  $(V_1''', \delta_1''') <_{\rho} (V_1'', \delta_1'')$ .

**Lemma 4.2.21.** Let  $(V_1', \delta_1'), (V_2', \delta_2')$  be two minimal weighted  $r$ -path vertex covers of  $(\Sigma_{r-1}G)_{\lambda}$ . Then  $(V_1', \delta_1') \leq_{\rho} (V_2', \delta_2')$  if and only if  $P(q(V_1'), \gamma_{(V_1', \delta_1')}) \subseteq P(q(V_2'), \gamma_{(V_2', \delta_2')})$ .

*Proof.*  $(V_1', \delta_1') \leq_{\rho} (V_2', \delta_2')$  if and only if  $q(V_1') \subseteq q(V_2')$  and  $\gamma_{(V_1', \delta_1')}|_{q(V_1')} \geq \gamma_{(V_2', \delta_2')}|_{q(V_1')}$  if and only if  $P(q(V_1'), \gamma_{(V_1', \delta_1')}) \subseteq P(q(V_2'), \gamma_{(V_2', \delta_2')})$ .  $\square$

**Example 4.2.22.** Consider the following two minimal weighted 3-path vertex covers  $(V_1'', \delta_1'') := \{v_{1,2}^5, v_2^3\}$  and  $(V_2'', \delta_2'') := \{v_{1,2}^5, v_{2,1}^3\}$  of  $(\Sigma_2 P_1)_{\lambda}$  from Example 4.2.18(a).

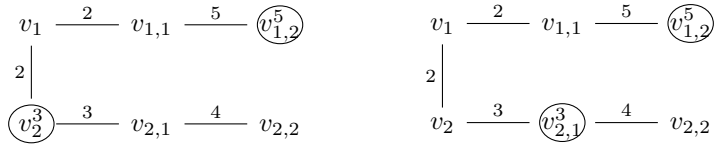

Then  $(V_2'', \delta_2'') <_{\rho} (V_1'', \delta_1'')$  by Example 4.2.18(a). Note also that

$$P(q(V_2''), \gamma_{(V_2'', \delta_2'')}) = (X_1^{12}, X_2^6)R \subseteq (X_1^{12}, X_2^3)R = P(q(V_1''), \gamma_{(V_1'', \delta_1'')}).$$

Next, we present our third and final decomposition result which will yield the type computation in Theorem 4.2.25.

**Theorem 4.2.23.** Given a weighted  $r$ -path suspension of  $G_{\omega}$   $(\Sigma_r G)_{\lambda}$  such that  $\lambda(v_i v_j) \leq \lambda(v_i, v_{i,1})$  and  $\lambda(v_i v_j) \leq \lambda(v_j, v_{j,1})$  for all edges  $v_i v_j \in E$ , we have an irredundant parametric decomposition

$$I_r((\Sigma_r G)_{\lambda})R = \bigcap_{(V'', \delta'') \text{ } \rho\text{-min. w. } r\text{-path v. c. of } (\Sigma_{r-1} G)_{\lambda'}} P(q(V''), \gamma_{(V'', \delta'')}) + \mathbf{m}^{[\underline{\alpha}(\lambda)]}, \quad \lambda' = \lambda|_{\Sigma_{r-1} G}.$$

*Proof.* By Fact 4.1.7 and [9, Theorem 7.5.3], to verify this result, it is enough to show that we have an irredundant decomposition

$$I_r((\Sigma_{r-1} G)_{\lambda'})R = \bigcap_{(V'', \delta'') \text{ } \rho\text{-min. w. } r\text{-path v. cover of } (\Sigma_{r-1} G)_{\lambda'}} P(q(V''), \gamma_{(V'', \delta'')}).$$

Lemma 4.2.21 shows that this intersection is irredundant. So by Corollary 4.2.11, it is enough to show that

$$\begin{aligned} & \bigcap_{(V'', \delta'') \text{ min. weighted } r\text{-path v. cover of } (\Sigma_{r-1}G)_{\lambda'}} P(q(V''), \gamma_{(V'', \delta'')}) \\ = & \bigcap_{(V'', \delta'') \mathcal{P}\text{-min. weighted } r\text{-path v. cover of } (\Sigma_{r-1}G)_{\lambda'}} P(q(V''), \gamma_{(V'', \delta'')}). \end{aligned}$$

$\subseteq$  follows as every  $\mathcal{P}$ -minimal weighted  $r$ -path vertex cover is a minimal weighted  $r$ -path vertex cover.

$\supseteq$  follows from Proposition 4.2.19 and Lemma 4.2.21.  $\square$

**Example 4.2.24.** Consider the graph  $(\Sigma_3 P_1)_\lambda$  from Example 4.2.12. Then by Theorem 4.2.23 and Example 4.2.18(b), we have an irredundant parametric decomposition

$$\begin{aligned} I_3((\Sigma_3 P_1)_\lambda) &= (X_1^{12} X_2^2, X_1^4 X_2^6, X_1^2 X_2^{11})R + \mathbf{m}^{[a(\lambda)]} \\ &= [(X_1^2)R \cap (X_2^2)R \cap (X_1^{12}, X_2^6)R \cap (X_1^4, X_2^{11})R] + (X_1^{14}, X_2^{13})R. \end{aligned}$$

The next theorem is the fourth main result of this thesis.

**Theorem 4.2.25.** Let  $(\Sigma_r G)_\lambda$  be a weighted  $r$ -path suspension of  $G_\omega$  such that  $\lambda(v_i v_j) \leq \lambda(v_i, v_{i,1})$  and  $\lambda(v_i v_j) \leq \lambda(v_j, v_{j,1})$  for all edges  $v_i v_j \in E$ .

$$r_{R'} \left( \frac{R'}{I_r((\Sigma_r G)_\lambda)} \right) = \# \{ \mathcal{P}\text{-minimal weighted } r\text{-path vertex covers of } (\Sigma_{r-1}G)_{\lambda'} \}, \quad \lambda' = \lambda|_{\Sigma_{r-1}G}.$$

*Proof.* We compute

$$\begin{aligned} r_{R'} \left( \frac{R'}{I_r((\Sigma_r G)_\lambda)} \right) &= r_{R'} \left( \frac{R'}{I_r((\Sigma_r G)_\lambda) + (X_i - X_{i,k} \mid 1 \leq i \leq d, 1 \leq k \leq r)R'} \right) \\ &= r_R \left( \frac{R}{I_r((\Sigma_r G)_\lambda)R} \right) \\ &= \# \{ \text{ideals in an irredundant parametric decomposition of } I_r((\Sigma_r G)_\lambda)R \} \\ &= \# \{ \mathcal{P}\text{-minimal weighted } r\text{-path vertex covers of } (\Sigma_{r-1}G)_{\lambda'} \}, \end{aligned}$$

where the first equality is from Facts 4.1.8(a) and 2.7.6, and Theorem 3.4.1, the second equality is from Theorem 3.4.1, the third equality is from Fact 2.7.7 since  $\dim \left( \frac{R}{I_r((\Sigma_r G)_\lambda)R} \right) = 0$ , and the last

equality is from Fact 4.2.23. □

**Remark.** Because of Fact 4.1.8, we use Theorem 4.2.25 to compute  $r_R(R/I_r(G_\omega))$  for all weighted trees  $G_\omega$  such that  $I_r(G_\omega)$  is Cohen-Macaulay.

**Example 4.2.26.** Consider Example 4.2.24. Then by Theorem 4.2.25, we have that

$$r_{R'}(R'/I_3(\Sigma_3 P_1)_\lambda) = 4.$$

We observe that the smallest number of vertices for one of the 3-path vertex covers of  $(\Sigma_3 P_1)_\lambda$  is 2. Then by Facts 3.1.7 and 2.2.28,  $\dim(R'/I_3((\Sigma_3 P_1)_\lambda)) = 8 - 2 = 6$ . Since  $R'/I_3((\Sigma_3 P_1)_\lambda)$  is Cohen-Macaulay by Fact 4.1.8(a),  $\text{depth}(R'/I_3((\Sigma_3 P_1)_\lambda)) = \dim(R'/I_3((\Sigma_3 P_1)_\lambda)) = 6$ . Hence

$$\text{Ext}_{R'}^6(\mathbb{K}, R'/I_3((\Sigma_3 P_1)_\lambda)) \cong \mathbb{K}^4.$$

# Chapter 5

## Future work

### 5.1 Generalized Weighted Simplicial Complex

The Stanley-Reisner correspondence uses simplicial complexes to study square-free monomial ideals. In order to use similar techniques to study certain non-square-free monomial ideals, in the future, we will define a weighted version of the notion and then define a weighted version of Stanley-Reisner ideals. As in the classical setting, we'll see whether these ideals yield an irredundant irreducible decomposition. In terms of the decomposition, we will define the Alexander dual of a weighted simplicial complex and dual of any monomial ideal, to see whether Alexander duality commutes with the weighted Stanley-Reisner correspondence, and see how it is related to the dual defined by E. Miller [8].

### 5.2 More classifications

We focus on classifying the edge-weighted graphs whose  $f$ -weighted  $r$ -path ideal is Cohen-Macaulay over a field  $\mathbb{K}$ . As for the unweighted case, we cannot expect a general classification theorem. We've completed the classification for weighted  $r$ -suspensions. In the future, we plan to use combinatorial analysis to classify all weighed  $K_n$ -coronas with  $n \geq 2$  and weighted chordal graphs such that their  $f$ -weighted  $r$ -path ideals are Cohen-Macaulay.

**Definition 5.2.1.** Let  $n \geq 1$ . A graph  $G$  is called a  $K_n$ -corona if there is a subgraph  $H$  of  $G$  such that each vertex of  $H$  is affixed a distinct completed graph  $K_n$ . An edge-weighted graph  $G_\omega$  is called

a *weighted  $K_n$ -corona* if the underlying graph  $G$  is  $K_n$ -corona.

**Definition 5.2.2.** A graph  $G$  is called *chordal* if every cycle of length  $> 3$  has a chord. An edge-weighted graph  $G_\omega$  is called a *weighted chord graph* if the underlying graph  $G$  is chordal.

The examples for the  $K_n$ -corona and chordal are in the following:

**Example 5.2.3.** Let  $G$  be the following graph.

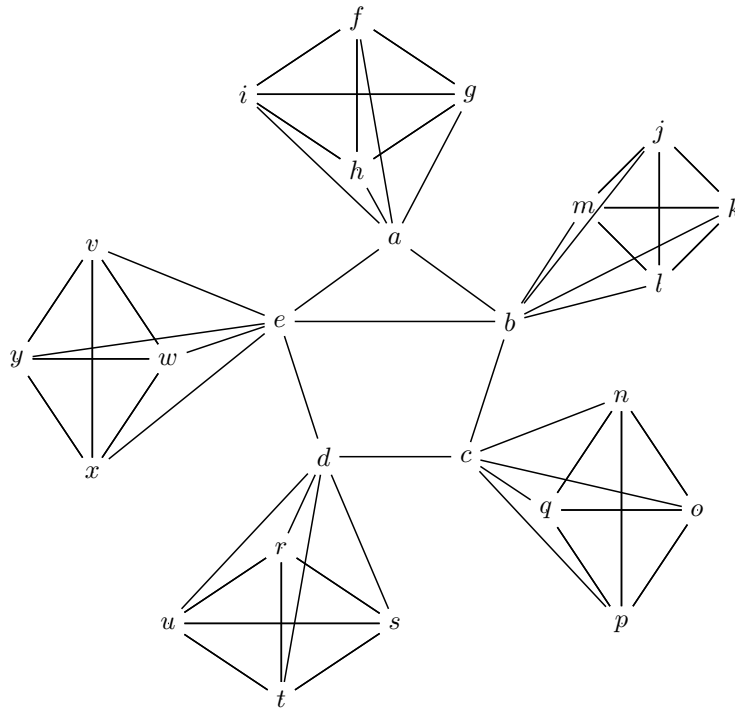

Then  $G$  is  $K_4$ -corona, since we have a subgraph  $H$  of  $G$

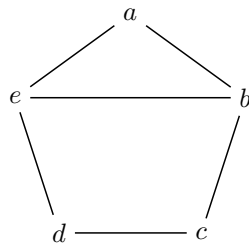

such that each vertex  $a, b, c, d, e$  of  $H$  is affixed to a distinct complete graph  $K_4$ . Note that  $G$  is not chordal since the 4-cycle  $b - c - d - e - b$  in  $G$  doesn't have a chord.



# Bibliography

- [1] Winfried Bruns and Jürgen Herzog. *Cohen-Macaulay rings revised edition*, volume 39 of *Cambridge Studies in Advanced Mathematics*. Cambridge University Press, Cambridge, 1993.
- [2] Daniel Campos, Ryan Gunderson, Susan Morey, Chelsey Paulsen, and Thomas Polstra. Depths and Cohen-Macaulay properties of path ideals. *J. Pure Appl. Algebra*, 218(8):1537–1543, 2014.
- [3] Aldo Conca and Emanuela De Negri.  $M$ -sequences, graph ideals, and ladder ideals of linear type. *J. Algebra*, 211(2):599–624, 1999.
- [4] Reinhard Diestel. *Graph theory*, volume 173 of *Graduate Texts in Mathematics*. Springer, Berlin, fifth edition, 2018. Paperback edition of [ MR3644391].
- [5] David S. Dummit and Richard M. Foote. *Abstract algebra*. John Wiley & Sons, Inc., Hoboken, NJ, third edition, 2004.
- [6] Jürgen Herzog, Takayuki Hibi, and Xinxian Zheng. Cohen-Macaulay chordal graphs. *J. Combin. Theory Ser. A*, 113(5):911–916, 2006.
- [7] Bethany Kubik and Keri Sather-Wagstaff. Path ideals of weighted graphs. *J. Pure Appl. Algebra*, 219(9):3889–3912, 2015.
- [8] Ezra Miller. Alexander duality for monomial ideals and their resolutions. *arXiv preprint math/9812095*, 1998.
- [9] W. Frank Moore, Mark Rogers, and Keri Sather-Wagstaff. *Monomial ideals and their decompositions*. Universitext. Springer, Cham, 2018.
- [10] Chelsey Paulsen and Keri Sather-Wagstaff. Edge ideals of weighted graphs. *J. Algebra Appl.*, 12(5):1250223, 24, 2013.
- [11] Keri Sather-Wagstaff. Homological algebra notes. *Unpublished lecture notes. Available at <http://ssather.people.clemson.edu/notes.html>*, 2009.
- [12] Richard P. Stanley. The upper bound conjecture and Cohen-Macaulay rings. *Studies in Applied Mathematics*, 54:135–142, 1975.
- [13] Rafael H. Villarreal. Cohen-Macaulay graphs. *Manuscripta Math.*, 66(3):277–293, 1990.
- [14] Shuai Wei. Cohen-Macaulay type of weighted edge ideals and path ideals. MS thesis, Clemson University, Clemson, SC, USA, 2019.