

8-2019

Cohen-Macaulay Type of Weighted Edge Ideals and Path Ideals

Shuai Wei

Clemson University, wei6@clemson.edu

Follow this and additional works at: https://tigerprints.clemson.edu/all_theses

Recommended Citation

Wei, Shuai, "Cohen-Macaulay Type of Weighted Edge Ideals and Path Ideals" (2019). *All Theses*. 3173.
https://tigerprints.clemson.edu/all_theses/3173

This Thesis is brought to you for free and open access by the Theses at TigerPrints. It has been accepted for inclusion in All Theses by an authorized administrator of TigerPrints. For more information, please contact kokeefe@clemson.edu.

COHEN-MACAULAY TYPE OF WEIGHTED EDGE IDEALS
AND PATH IDEALS

A Thesis
Presented to
the Graduate School of
Clemson University

In Partial Fulfillment
of the Requirements for the Degree
Master of Science
Mathematical Sciences

by
Shuai Wei
August 2019

Accepted by:
Dr. Sean Sather-Wagstaff, Committee Chair
Dr. Michael Burr
Dr. Matthew Macauley

Abstract

Type is an important invariant of a Cohen-Macaulay homogeneous ideal I in a polynomial ring $A[X_1, \dots, X_d]$, where A is a field. In Chapter 2, we recall the algebraic definition of type using Ext modules and depth. First we recall how the Cohen-Macaulay property is defined, how Ext is defined via projective resolutions and how depth is defined through regular sequences or vanishing of Ext. Chapter 2 also contains other necessary background information.

We mainly work with monomial ideals I in the ring $R = A[X_1, \dots, X_d]$ and the case where the Krull dimension of R/I is zero, implying that I is Cohen-Macaulay and has an irredundant parametric decomposition. In this case, the type of R/I has a computational-friendly formula:

$$\text{type}(R/I) = \# \text{ parameter ideals occurring in the irredundant parametric decomposition of } I.$$

The goal of this thesis is to use this to derive formulas for the type of other Cohen-Macaulay quotients. We focus on ideals coming from (finite simple) graphs G ; our formulas are in terms of graph-theoretical data about G . This falls in the general area of combinatorial commutative algebra, where one uses natural connections between the algebraic properties of a given monomial ideal I in $A[X_1, \dots, X_d]$ and combinatorics.

Let G be a graph with vertex set $\{v_1, \dots, v_d\}$. Let ΣG be the suspension of G (see Definition 3.12). In Chapter 3, we define the edge ideal $I(\Sigma G)$ in $R' = A[X_1, \dots, X_d, Y_1, \dots, Y_d]$ (see Definition 3.1), and we compute the type of the quotient $R'/I(\Sigma G)$ combinatorially, which is found to be exactly the number of minimal vertex covers of G :

$$\text{type}(R'/I(\Sigma G)) = \# \text{ minimal vertex covers of } G. \quad (*)$$

We prove this in Theorem 3.20. In particular, this computes $\text{type}(R/I(G))$ for all trees such that $R/I(G)$ is Cohen-Macaulay (see Fact 3.18(b)).

Next, given a weighted graph G_ω , a weighted suspension $(\Sigma G)_\lambda$ (see Definition 3.39) with λ satisfying the conditions in Fact 3.40, and its weighted edge ideal $I((\Sigma G)_\lambda)$ (see Definition 3.25), we go further to explore the type of the quotient $R'/I((\Sigma G)_\lambda)$, defined and studied by Paulsen and Sather-Wagstaff [9]. As with Formula (*), we find that the type of $R'/I((\Sigma G)_\lambda)$ is exactly the number of minimal weighted vertex covers of G_ω :

$$\text{type}(R'/I((\Sigma G)_\lambda)) = \# \text{ minimal weighted vertex covers of } G_\omega. \quad (**)$$

We prove this in Theorem 3.43. In particular, this computes $\text{type}(R/I(G_\omega))$ for all weighted trees such that $R/I(G_\omega)$ is Cohen-Macaulay (see Fact 3.41(b)).

Finally, with $\Sigma_r G$ being the r -path suspension of G (see Definition 3.45), and $I_r(\Sigma_r G)$ the r -path ideal of $\Sigma_r G$ (see Definition 3.47), we determine the type of the quotient $R'/I_r(\Sigma_r G)$, which is given by the number of “ \mathcal{P} -minimal r -path vertex covers of $\Sigma_{r-1} G$ ”, in terms of an order on the minimal r -path vertex covers of $\Sigma_r G$. Using similar techniques, plus some extra effort, we deduce the formula

$$\text{type}(R'/I_r(\Sigma_r G)) = \# \mathcal{P}\text{-minimal } r\text{-path vertex covers of } \Sigma_{r-1} G. \quad (***)$$

We prove this in Theorem 3.71. In particular, this computes $\text{type}(R/I_r(G))$ for all trees such that $R/I_r(G)$ is Cohen-Macaulay (see Fact 3.58(b)).

Acknowledgments

I would like to express my special appreciation and thanks to Prof. Sean Sather-Wagstaff for the friendly guidance, useful comments and tremendous engagement throughout all stages of the work.

I would also like to thank my committee members, Prof. Michael Burr and Prof. Matthew Macauley for your brilliant comments and suggestions which have contributed greatly to the improvement of the thesis.

Contents

Title Page	i
Abstract	ii
Acknowledgments	iv
1 Introduction	1
2 Definitions and Background	3
2.1 Commutative Rings with Identity	3
2.2 Regular Sequences	4
2.3 Ext via Projective Resolutions	5
2.4 Krull Dimension, Depth and Type	10
2.5 Monomial Ideals	12
2.6 Homogeneous Cohen-Macaulay Rings	20
3 Cohen-Macaulay Type of Weighted Edge Ideals and Path Ideals	23
3.1 Connections Between Combinatorics and Monomial Ideals	23
3.2 The Type of $R'/I(\Sigma G)$	25
3.3 Weighted Edge Ideals $I(G_\omega)$ and the Type of $R'/I((\Sigma G)_\lambda)$	30
3.4 Path Ideals and the Type of $R'/I_r(\Sigma_r G)$	36
Bibliography	51

Chapter 1

Introduction

Combinatorial commutative algebra is a branch of mathematics that uses combinatorics and graph theory to understand certain algebraic constructions; it also uses algebra to understand certain objects in combinatorics and graph theory. In this thesis, we explore aspects of this area via edge ideals and path ideals of graphs and weighted graphs.

Let G be a (finite simple) graph with vertex set $V = V(G) = \{v_1, \dots, v_d\}$ and edge set $E = E(G)$. Let A be a field, and consider the polynomial ring $R = A[X_1, \dots, X_d]$. The *edge ideal* of G is the ideal $I(G)$ of R that is “generated by the edges of G .”

$$I(G) = (X_i X_j \mid v_i v_j \in E)R.$$

Some research in combinatorial commutative algebra uses graph-theoretic properties of G to understand algebraic properties of $I(G)$, and vice versa.

An important concept in commutative algebra is the “Cohen-Macaulay” property; see Definition 2.92. The definition is somewhat technical. For now, the reader should understand that Cohen-Macaulay ideals in polynomial rings are particularly nice. If I is a Cohen-Macaulay ideal in R , the “type” of R/I roughly measures how nice the ideal is. For instance, some of the nicest Cohen-Macaulay ideals are the “Gorenstein” ideals, which end up being the Cohen-Macaulay ideals of type 1.

If G is a tree, a theorem of Villarreal [11] characterizes when $I(G)$ is Cohen-Macaulay; see Fact 3.18. This characterization is purely graph-theoretical. One of the first goals of this

thesis is to compute the type of $R/I(G)$ for arbitrary Cohen-Macaulay trees. We accomplish this in Theorem 3.20. As with Villarreal's result, this computation is purely graph-theoretical. In subsequent results of this thesis, we compute the type for other graph-theoretic algebra constructions the edge ideal of a weighted tree and the path ideal of a tree when they are Cohen-Macaulay. These results are in Theorems 3.43 and 3.71. These are the main results of this thesis. They form the bulk of Chapter 3. Necessary background information is collected in Chapter 2 and Section 3.2.

Chapter 2

Definitions and Background

Convention. In this chapter, let R be a commutative ring with identity, M an R -module and $I \subseteq R$ an ideal.

2.1 Commutative Rings with Identity

Definition 2.1. We say R is *local* if it has a unique maximal ideal \mathfrak{m} , also known as “*quasi-local*”. The *residue field* of R is R/\mathfrak{m} .

“Assume (R, \mathfrak{m}, k) is local” or “assume (R, \mathfrak{m}) is local”, means that \mathfrak{m} is the unique maximal ideal of R and $k = R/\mathfrak{m}$.

Example 2.2. Let \mathfrak{k} be a field.

- (a) \mathfrak{k} is local with the maximal ideal (0) .
- (b) $R = \mathfrak{k}[X]/(X^n)$ is local with $\mathfrak{m} = (X)/(X^n)$.
- (c) Let $R = \mathfrak{k}[X_1, \dots, X_d]/(X_1^{a_1}, \dots, X_d^{a_d})$, where $a_i \geq 1$ for $i = 1, \dots, d$. Then R is local with $\mathfrak{m} = (X_1, \dots, X_d)/(X_1^{a_1}, \dots, X_d^{a_d})$.

Definition 2.3. Let $U \subseteq R$ be multiplicatively closed and $1 \in U$. The *localization of M with respect to U* is defined to be

$$U^{-1}M = \{\text{equivalence classes from } M \times U \text{ under } \sim\},$$

where $(m, u) \sim (n, u)$ if there exists $w \in U$ such that $w(vm - un) = 0$. Denote the equivalence class of (m, u) as $\frac{m}{u}$ or m/u .

Notation 2.4. Set $M_{\mathfrak{p}} = (R \setminus \mathfrak{p})^{-1}M$ for any prime ideal $\mathfrak{p} \subseteq R$.

Definition 2.5. The *radical* of an ideal $\mathfrak{a} \subseteq R$ is defined to be

$$\text{rad}(\mathfrak{a}) = \mathfrak{r}(\mathfrak{a}) = \sqrt{\mathfrak{a}} = \{x \in R \mid x^n \in \mathfrak{a}, \forall n \gg 0\} = \{x \in R \mid x^n \in \mathfrak{a} \text{ for some } n \geq 1\}.$$

Definition 2.6. I is *reducible* if there exist ideals $J, K \subseteq R$ such that $I = J \cap K$ and $J \neq I$ and $K \neq I$. I is *irreducible* if it is not reducible and $I \neq R$.

Definition 2.7. An *irreducible decomposition* of I is an expression $I = \bigcap_{i=1}^n J_i$ with $n \geq 1$ such that ideals $J_1, \dots, J_n \subseteq R$ are irreducible.

Definition 2.8. An irreducible decomposition $I = \bigcap_{i=1}^n J_i$ is *redundant* if $I = \bigcap_{i \neq k} J_i$ for some $k \in \{1, \dots, n\}$. An irreducible decomposition $I = \bigcap_{i=1}^n J_i$ is *irredundant* if it is not redundant, that is, if every $k \in \{1, \dots, n\}$ satisfies $J \neq \bigcap_{i \neq k} J_i$. As $J = \bigcap_{i=1}^n J_i \subseteq \bigcap_{i \neq k} J_i$ holds automatically, the given decomposition is irredundant if and only if every $k \in \{1, \dots, d\}$ satisfies $J \not\subseteq \bigcap_{i \neq k} J_i$.

Fact 2.9. [8, Corollaries 1.4.6 and 3.4.8] Let $d \geq 1$. If A is a Noetherian ring, then every proper ideal in A or $A[X_1, \dots, X_d]$ has an irredundant irreducible decomposition.

2.2 Regular Sequences

Depth is an important invariant of rings and modules in commutative and homological algebra. It is defined in terms of the vanishing of Ext modules and it characterizes the length of maximal regular sequences.

Definition 2.10. An element $x \in R$ is a *non-zero divisor* on M if the multiplication by x map $M \xrightarrow{x} M$ is 1-1; equivalently, for $m \in M$, if $xm = 0$, then $m = 0$. Set

$$\text{NZD}_R(M) = \{a \in R \mid a \text{ is a nonzero divisor on } M\}.$$

Definition 2.11. An element $x \in R$ is *M -regular* if

- (a) $x \in \text{NZD}_R(M)$ and

(b) $xM \neq M$.

Definition 2.12. A sequence $a_1, \dots, a_n \in I$ is *M-regular* if

(a) a_1 is *M-regular*, and

(b) a_i is $\frac{M}{(a_1, \dots, a_{i-1})M}$ -regular for $i = 2, \dots, n$,

Remark. Note that for $a_1, \dots, a_i \in R$, we have

$$\frac{M}{(a_1, \dots, a_i)M} \stackrel{\textcircled{1}}{\cong} \frac{M/(a_1, \dots, a_{i-1})M}{(a_1, \dots, a_i)M/(a_1, \dots, a_{i-1})M} \cong \frac{M/(a_1, \dots, a_{i-1})M}{a_i M/(a_1, \dots, a_{i-1})M},$$

where $\textcircled{1}$ is from the third isomorphism theorem for modules. Thus, we have $a_i M/(a_1, \dots, a_{i-1})M \neq M/(a_1, \dots, a_{i-1})M$ if and only if $M/(a_1, \dots, a_i)M \neq 0$. This observation justifies the following equivalent definition for *M-regular* sequences.

Definition 2.13. A sequence $a_1, \dots, a_n \in I$ is *M-regular* if

(a) $a_1 \in \text{NZD}_R(M)$,

(b) $a_i \in \text{NZD}_R(M/(a_1, \dots, a_{i-1})M)$ for $i = 2, \dots, n$, and

(c) $(a_1, \dots, a_n)M \neq M$.

Remark. Condition (c) in Definition 2.13 is sometimes automatic, e.g., if (R, \mathfrak{m}) is local with $a_1, \dots, a_n \in \mathfrak{m}$ and M is nonzero and finitely generated, then by Nakayama's lemma, we have $(a_1, \dots, a_n)M \subseteq \mathfrak{m}M \subsetneq M$.

Definition 2.14. A sequence $a_1, \dots, a_n \in I$ is a *maximal M-regular sequence in I* if a_1, \dots, a_n is an *M-regular* sequence in I such that for all $b \in I$, the longer sequence a_1, \dots, a_n, b is not *M-regular*.

Example 2.15. A list of variables X_1, \dots, X_n is $A[X_1, \dots, X_n]$ -regular for any commutative ring A .

2.3 Ext via Projective Resolutions

In this section, let N be another R -module. We present some definitions and facts from homological algebra leading to the definition of *Ext*.

Definition 2.16. A sequence $A \xrightarrow{f} B \xrightarrow{g} C$ of R -module homomorphism is *exact* (at B) if $\text{Im}(f) = \text{Ker}(g)$. Note that $\text{Im}(f) \subseteq \text{Ker}(g)$ if and only if $g \circ f = 0$.

More generally, a sequence of R -module homomorphism

$$\cdots \xrightarrow{d_{i+1}} X_i \xrightarrow{d_i} X_{i-1} \xrightarrow{d_{i-1}} \cdots$$

is *exact* if $\text{Im}(d_{i+1}) = \text{Ker}(d_i)$ for all $i \in \mathbb{Z}$.

Fact 2.17. We have the following facts:

- (a) The sequence $0 \rightarrow A \xrightarrow{f} A'$ of R -module homomorphisms is exact (at A) if and only if f is 1-1.
- (b) The sequence $B' \xrightarrow{g} B \rightarrow 0$ of R -module homomorphisms is exact (at B) if and only if g is onto.
- (c) The sequence $0 \rightarrow A \xrightarrow{f} B \xrightarrow{g} C \rightarrow 0$ of R -module homomorphisms is exact if f is 1-1, g is onto and $\text{Im}(f) = \text{Ker}(g)$.

Definition 2.18. A *short exact sequence* is an exact sequence of the form

$$0 \rightarrow U \xrightarrow{\alpha} V \xrightarrow{\beta} W \rightarrow 0.$$

Definition 2.19. A *homomorphism of short exact sequences* is a triple (α, β, γ) of R -module homomorphisms such that the following diagram commutes:

$$\begin{array}{ccccccccc} 0 & \longrightarrow & A & \xrightarrow{f} & B & \xrightarrow{g} & C & \longrightarrow & 0 \\ & & \downarrow \alpha & & \downarrow \beta & & \downarrow \gamma & & \\ 0 & \longrightarrow & A' & \xrightarrow{f'} & B' & \xrightarrow{g'} & C' & \longrightarrow & 0 \end{array}$$

Fact 2.20 (The Short Five Lemma). [4, Proposition 10.24] Let (α, β, γ) be a homomorphisms of short exact sequences

$$\begin{array}{ccccccccc} 0 & \longrightarrow & A & \xrightarrow{f} & B & \xrightarrow{g} & C & \longrightarrow & 0 \\ & & \downarrow \alpha & & \downarrow \beta & & \downarrow \gamma & & \\ 0 & \longrightarrow & A' & \xrightarrow{f'} & B' & \xrightarrow{g'} & C' & \longrightarrow & 0. \end{array}$$

- (a) If α and γ are 1-1, then so is β .
- (b) If α and γ are onto, then so is β .
- (c) If α and γ are isomorphisms, then so is β .

Definition 2.21. A short exact sequence $0 \rightarrow A \xrightarrow{f} B \xrightarrow{g} C \rightarrow 0$ is *split* if and only if it is equivalent to the canonical exact sequence $0 \rightarrow A \xrightarrow{\epsilon} A \oplus C \xrightarrow{\rho} C \rightarrow 0$, i.e., if and only if there exists a commutative diagram

$$\begin{array}{ccccccccc} 0 & \longrightarrow & A & \xrightarrow{f} & B & \xrightarrow{g} & C & \longrightarrow & 0 \\ & & =\downarrow & & \beta\downarrow & & =\downarrow & & \\ 0 & \longrightarrow & A & \xrightarrow{\epsilon} & A \oplus C & \xrightarrow{\rho} & C & \longrightarrow & 0. \end{array}$$

In this event, β is an isomorphism by the short five lemma, and then β is an R -module isomorphism, so $B \cong A \oplus C$.

Notation 2.22.

$$\text{Hom}_R(M, N) := \{R\text{-module homomorphisms } f : M \rightarrow N\},$$

which is an R -module because R is commutative.

Let A, B be R -modules. For each $f \in \text{Hom}_R(A, B)$, define

$$\begin{aligned} f^* &= \text{Hom}_R(f, N) : \text{Hom}_R(B, N) \longrightarrow \text{Hom}_R(A, N) \\ &\phi \longmapsto \phi \circ f. \end{aligned}$$

$$\begin{array}{ccc} A & \xrightarrow{f} & B \\ & \searrow f^*(\phi) & \downarrow \phi \\ & & N \end{array}$$

Then f^* an R -module homomorphism.

Fact 2.23. $\text{Hom}_R(-, N)$ is a *contravariant functor*, i.e.,

- (a) it respects identity maps: $\text{Hom}_R(\text{id}_M, N) = \text{id}_{\text{Hom}_R(M, N)}$, and
- (b) it respects compositions: for all R -module homomorphisms $A \xrightarrow{\alpha} B \xrightarrow{\beta} C$,

$$\text{Hom}_R(\beta \circ \alpha, N) = \text{Hom}_R(\alpha, N) \circ \text{Hom}_R(\beta, N).$$

Or equivalently, $(\beta \circ \alpha)^* = \alpha^* \circ \beta^*$, i.e., the following diagram commutes:

$$\text{Hom}(-, N) : \begin{array}{ccc} \text{Hom}_R(A, N) & \xleftarrow{\text{Hom}_R(\alpha, N)} & \text{Hom}_R(B, N) \\ & \searrow \text{Hom}_R(\beta \circ \alpha, N) & \uparrow \text{Hom}_R(\beta, N) \\ & & \text{Hom}_R(C, N). \end{array}$$

Fact 2.24 (Left Exactness of $\text{Hom}(-, N)$). [4, Theorem 10.33] Let $A \xrightarrow{\alpha} B \xrightarrow{\beta} C \rightarrow 0$ be exact. Then the induced sequence $0 \rightarrow \text{Hom}(C, N) \xrightarrow{\beta^*} \text{Hom}(B, N) \xrightarrow{\alpha^*} \text{Hom}(A, N)$ is exact.

Remark. The functor $\text{Hom}(N, -)$ is defined similarly with notation $f_* = \text{Hom}(N, f)$. This functor is covariant and left exact.

Fact 2.25. [4, Theorem 10.30] The following conditions are equivalent.

- (i) $\text{Hom}_R(N, -)$ transforms epimorphisms into epimorphisms.
- (ii) $\text{Hom}_R(N, -)$ transforms short exact sequences into short exact sequences.
- (iii) $\text{Hom}_R(N, -)$ transforms exact sequences into exact sequences.
- (iv) Every short exact sequence $0 \rightarrow A \rightarrow B \rightarrow N \rightarrow 0$ splits.
- (v) For R -modules B and C , if $B \xrightarrow{\beta} C \rightarrow 0$ is exact, then every R -module homomorphism from N to C lifts to an R -module homomorphism into B , i.e., given $\phi \in \text{Hom}_R(N, C)$, there is a map $\psi \in \text{Hom}_R(N, B)$ making the following diagram commute:

$$\begin{array}{ccc} & N & \\ \exists \psi \swarrow & \downarrow \phi & \\ B & \xrightarrow{\beta} C & \longrightarrow 0. \end{array}$$

- (vi) There exists an R -module N' such that $N \oplus N'$ is free, i.e., N is a summand of a free R -module.

Definition 2.26. An R -module P is called *projective* if it satisfies any of the equivalent conditions of Fact 2.25.

Definition 2.27. A *chain complex* or *R -complex* is a sequence of R -module homomorphisms

$$M_\bullet = \cdots \xrightarrow{\partial_{i+1}^M} M_i \xrightarrow{\partial_i^M} M_{i-1} \xrightarrow{\partial_{i-1}^M} \cdots$$

such that $\partial_{i-1}^M \circ \partial_i^M = 0$ for all $i \in \mathbb{Z}$. We say M_i is the module in *degree* i in the R -complex M_\bullet .

The i^{th} homology module of an R -complex M_\bullet is the R -module

$$H_i(M_\bullet) = \text{Ker}(\partial_i^M) / \text{Im}(\partial_{i+1}^M).$$

Definition 2.28. A *projective resolution* of M over R or an *R -projective resolution* of M is an exact sequence of R -module homomorphisms

$$P_\bullet^+ = \cdots \xrightarrow{\partial_2^P} P_1 \xrightarrow{\partial_1^P} P_0 \xrightarrow{\tau} M \rightarrow 0$$

such that each P_i is a projective R -module.

The *truncated projective resolution* of M associated to P_\bullet^+ is the R -complex

$$P_\bullet = \cdots \xrightarrow{\partial_2^P} P_1 \xrightarrow{\partial_1^P} P_0 \rightarrow 0.$$

Define the R -complex $\text{Hom}(P_\bullet^+, N)$ as follows:

$$\text{Hom}(P_\bullet^+, N) = 0 \rightarrow M^* \xrightarrow{\tau^*} P_0^* \xrightarrow{(\partial_1^P)^*} P_1^* \xrightarrow{(\partial_2^P)^*} \cdots \xrightarrow{(\partial_{i-1}^P)^*} P_{i-1}^* \xrightarrow{(\partial_i^P)^*} P_i^* \xrightarrow{(\partial_{i+1}^P)^*} \cdots,$$

where we set $P_i^* = \text{Hom}(P_i, N)$ and $(\partial_i^P)^* = \text{Hom}(\partial_i^P, N)$ for $i \geq 0$. Define the R -complex P_\bullet^* as follows:

$$P_\bullet^* = \text{Hom}(P_\bullet, N) = 0 \rightarrow P_0^* \xrightarrow{(\partial_1^P)^*} P_1^* \xrightarrow{(\partial_2^P)^*} \cdots \xrightarrow{(\partial_{i-1}^P)^*} P_{i-1}^* \xrightarrow{(\partial_i^P)^*} P_i^* \xrightarrow{(\partial_{i+1}^P)^*} \cdots.$$

Let P_i^* be in degree $-i$, i.e., $P_i^* = (P^*)_{-i}$ for each $i \geq 1$. Then

$$\begin{array}{cccccccccccc} P_\bullet^* = 0 & \longrightarrow & P_0^* & \xrightarrow{(\partial_1^P)^*} & P_1^* & \xrightarrow{(\partial_2^P)^*} & \cdots & \xrightarrow{(\partial_{i-1}^P)^*} & P_{i-1}^* & \xrightarrow{(\partial_i^P)^*} & P_i^* & \xrightarrow{(\partial_{i+1}^P)^*} & \cdots \\ & & \parallel & & \parallel & & & & \parallel & & \parallel & & \\ P_\bullet^* = 0 & \rightarrow & (P^*)_0 & \xrightarrow{\partial_0^{P^*}} & (P^*)_{-1} & \xrightarrow{\partial_{-1}^{P^*}} & \cdots & \xrightarrow{\partial_{-i+2}^{P^*}} & (P^*)_{-i+1} & \xrightarrow{\partial_{-i+1}^{P^*}} & (P^*)_{-i} & \xrightarrow{\partial_{-i}^{P^*}} & \cdots \end{array}$$

In particular,

$$\partial_i^{P^*} = (\partial_{-i+1}^P)^*, \quad \forall i \leq 0.$$

By convention, we have $\partial_i^{P^*} = 0$ for all $i \geq 1$.

Remark. Because of the condition $\partial_i^P \circ \partial_{i+1}^P = 0$ for $i \geq 1$, by Fact 2.23, we have

$$(\partial_{i+1}^P)^* \circ (\partial_i^P)^* = (\partial_i^P \circ \partial_{i+1}^P)^* = 0^* = 0, \quad \forall i \geq 1.$$

Thus, $\text{Hom}(P_\bullet, N)$ and similarly $\text{Hom}(P_\bullet^+, N)$ are R -complexes.

Definition 2.29 (Ext via projective resolutions). Let P_\bullet^+ be a projective resolution of M . Define the Ext module by

$$\text{Ext}_R^i(M, N) := \text{H}_{-i}(P_\bullet^*) = \text{Ker}(\partial_{-i}^{P^*}) / \text{Im}(\partial_{-i+1}^{P^*}) = \text{Ker}((\partial_{i+1}^P)^*) / \text{Im}((\partial_i^P)^*).$$

Fact 2.30. Let P_\bullet^+ be a projective resolution of M . By the left exactness of Hom , we have an exact sequence:

$$0 \rightarrow M^* \xrightarrow{\tau^*} P_0^* \xrightarrow{(\partial_1^P)^*} P_1^*.$$

Then we have

$$\text{Ext}_R^0(M, N) = \text{Ker}(\partial_1^{P^*}) / \text{Im}(0) \cong \text{Ker}((\partial_1^P)^*) = \text{Im}(\tau^*) \cong M^* = \text{Hom}_R(M, N),$$

$$\text{Ext}_R^{-1}(M, N) = \text{Ker}(0 \rightarrow P_0^*) / \text{Im}(0 \rightarrow 0) = 0/0 = 0,$$

$$\text{Ext}_R^i(M, N) = \text{Ker}(0 \rightarrow 0) / \text{Im}(0 \rightarrow 0) = 0/0 = 0, \quad \forall i \leq -2.$$

Remark. $\text{Ext}_R^i(M, N)$ is well-defined, i.e., independent of the choices of projective resolution of M , by [10, Theorem VIII.5.2].

Remark. We can also define the Ext module via *injective modules*, but this is not needed for this thesis.

2.4 Krull Dimension, Depth and Type

In this section, we define Krull dimension of M and depth of M in I , then we define type of M when (R, \mathfrak{m}) is local.

Definition 2.31. The *prime spectrum* of R is

$$\text{Spec}(R) = \{\text{prime ideals of } R\}.$$

Let $V(I)$ denote the set of prime ideals in R containing I :

$$V(I) = \{\mathfrak{p} \in \text{Spec}(R) \mid I \subseteq \mathfrak{p}\}.$$

The *support* of M is the set

$$\text{Supp}_R(M) = \{\mathfrak{p} \in \text{Spec}(R) \mid M_{\mathfrak{p}} \neq 0\}.$$

Fact 2.32. It is straightforward to show that

$$\text{Supp}_R(R) = \text{Spec}(R),$$

and

$$\text{Supp}_R(R/I) = V(I).$$

Definition 2.33. The *Krull dimension* of M is

$$\dim_R(M) = \sup\{n \geq 0 \mid \exists \text{ a chain } \mathfrak{p}_0 \subsetneq \mathfrak{p}_1 \subsetneq \cdots \subsetneq \mathfrak{p}_n \text{ in } \text{Supp}_R(M)\}.$$

Set $\dim(R) = \dim_R(R)$.

Based on Fact 2.32, we have the following Krull dimension definitions for rings and quotient rings.

Definition 2.34. (a) The *Krull dimension* of R is

$$\dim(R) = \sup\{n \geq 0 \mid \exists \text{ a chain } \mathfrak{p}_0 \subsetneq \mathfrak{p}_1 \subsetneq \cdots \subsetneq \mathfrak{p}_n \text{ in } \text{Spec}(R)\}.$$

(b) The *Krull dimension* of R/I is

$$\dim(R/I) = \sup\{n \geq 0 \mid \exists \text{ a chain } \mathfrak{p}_0 \subsetneq \mathfrak{p}_1 \subsetneq \cdots \subsetneq \mathfrak{p}_n \text{ in } V(I)\}.$$

Assumption. For the remainder of this section, we assume R is Noetherian and M is finitely generated.

Fact 2.35. [10, Corollary V.5.12] If $IM \neq M$, then each maximal M -regular sequence in I has the same length, namely

$$\inf\{i \geq 0 \mid \text{Ext}_R^i(R/I, M) \neq 0\}.$$

Through Fact 2.35, we have the following definition for depth:

Definition 2.36. If $IM \neq M$, we define *depth* of M in I by

$$\text{depth}_R(I; M) = \inf\{i \geq 0 \mid \text{Ext}_R^i(R/I, M) \neq 0\}.$$

If $IM = M$, then set $\text{depth}_R(I; M) = \infty$.

Remark. If (R, \mathfrak{m}) is local and $M \neq 0$, then by Nakayama's lemma, $IM \subseteq \mathfrak{m}M \subsetneq M$, so $IM \neq M$.

Notation 2.37. If (R, \mathfrak{m}, k) is local, set $\text{depth}_R(M) = \text{depth}_R(\mathfrak{m}; M)$

Definition 2.38. Let (R, \mathfrak{m}, k) be local and $M \neq 0$. Assume $\text{depth}_R(M) = n$. The *type* of M is the positive integer

$$\text{type}_R(M) = \dim_k(\text{Ext}_R^n(k, M)).$$

2.5 Monomial Ideals

In this section, we introduce monomial ideals and a way of understanding them combinatorially. Let A be a commutative ring with identity, $R = A[X_1, \dots, X_d]$ unless otherwise stated. Set $\mathfrak{X} = (X_1, \dots, X_d)R$, the ideal generated by all variables in R and $\mathbb{N}_0 = \{0, 1, 2, \dots\}$.

Definition 2.39. A *monomial* in elements $X_1, \dots, X_d \in R$ is an element of the form $X_1^{n_1} \cdots X_d^{n_d}$ in R , where $n_1, \dots, n_d \in \mathbb{N}_0$. For short, we write $\underline{n} = (n_1, \dots, n_d) \in \mathbb{N}_0^d$ and $\underline{X}^{\underline{n}} = X_1^{n_1} \cdots X_d^{n_d}$.

Notation 2.40. Let $\underline{m}, \underline{n} \in \mathbb{N}_0^d$. Write $\underline{m} \succ \underline{n}$ when $m_i \geq n_i$ for $i = 1, \dots, d$. For each $\underline{n} \in \mathbb{N}_0^d$, set

$$\langle \underline{n} \rangle = \{\underline{m} \in \mathbb{N}_0^d \mid \underline{m} \succ \underline{n}\} = \underline{n} + \mathbb{N}_0^d.$$

Example 2.41. We describe the two sets $\langle(1, 2)\rangle$ and $\langle(1, 2)\rangle \cup \langle(3, 1)\rangle$ in the following graphs.

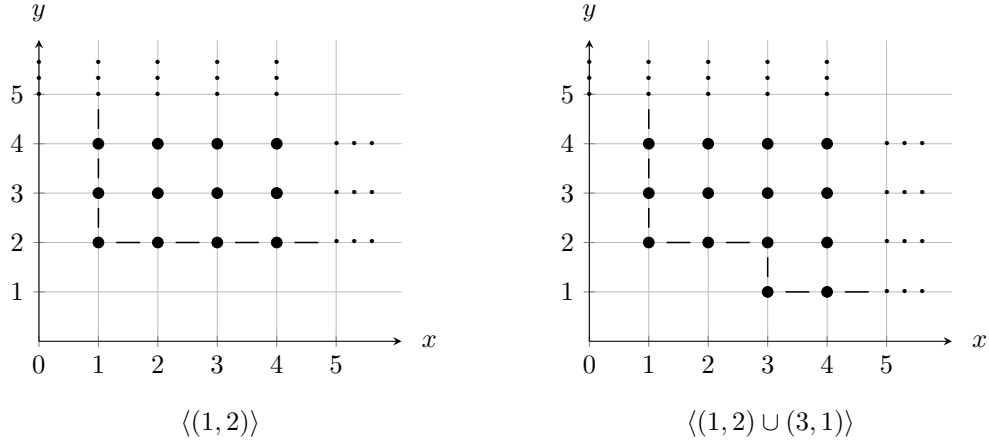

where bullets represent points in the appropriate set.

Definition 2.42. Denote the set of monomials in R by

$$\llbracket R \rrbracket = \{ \underline{X}^{\underline{n}} \mid \underline{n} \in \mathbb{N}_0^d \}.$$

Definition 2.43. A *monomial ideal* I in R is an ideal generated by monomials in X_1, \dots, X_d , i.e., elements of the form $\underline{X}^{\underline{n}}$ with $\underline{n} \in \mathbb{N}_0^d$.

Remark. The trivial ideals 0 and R are monomial ideals since $0 = (\emptyset)R$ and $R = (1)R = (X_1^0 \cdots X_d^0)R$.

Assumption. For the remainder of this section, let $I \subseteq R$ be a monomial ideal.

Fact 2.44 (Dickson's Lemma). [8, Theorem 1.3.1] I is finitely generated by a set of monomials.

Definition 2.45. Denote the set of monomials in I by

$$\llbracket I \rrbracket = \{ \underline{X}^{\underline{n}} \in I \mid \underline{n} \in \mathbb{N}_0^d \} = I \cap \llbracket R \rrbracket.$$

Fact 2.46. [8, Lemma 1.1.10] For each $f \in I$, each monomial occurring in f is in I .

Definition 2.47. The *graph* of I is

$$\Gamma(I) = \{ \underline{n} \in \mathbb{N}_0^d \mid \underline{X}^{\underline{n}} \in I \} \subseteq \mathbb{N}_0^d.$$

Fact 2.48. [8, Theorem 1.1.12] Let $I = (\underline{X}^{n_1}, \dots, \underline{X}^{n_t})$ with $n_1, \dots, n_t \in \mathbb{N}_0^d$. Then

$$\Gamma(I) = \langle n_1 \rangle \cup \dots \cup \langle n_t \rangle.$$

Example 2.49. Let $R = A[X, Y]$ and $I = (X^4, X^3Y, Y^2)R$. Then $\Gamma(I) = \langle (4, 0) \rangle \cup \langle (3, 1) \rangle \cup \langle (0, 2) \rangle \subseteq \mathbb{N}_0^2$. We draw $\Gamma(I)$ in the following graph.

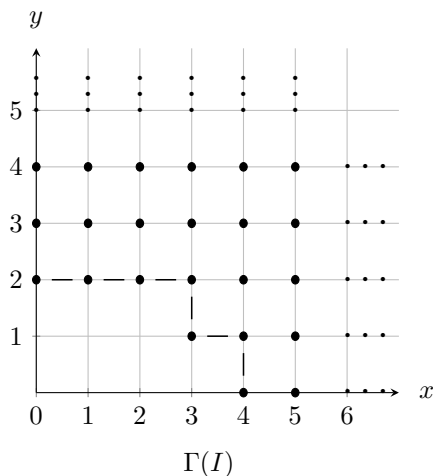

Definition 2.50. Define the *monomial radical* of I by

$$\text{m-rad}(I) = (\text{rad}(I) \cap \llbracket R \rrbracket)R,$$

where $\text{rad}(I)$ is the radical of I .

Example 2.55 shows that $\text{rad}(I)$ may not be a monomial ideal.

Fact 2.51. [8, Proposition 2.3.2] We have the following facts:

- (a) $\text{m-rad}(I) \subseteq \text{rad}(I)$.
- (b) $\text{m-rad}(I) = \text{rad}(I)$ if and only if $\text{rad}(I)$ is a monomial ideal.
- (c) If A is a field, then $\text{m-rad}(I) = \text{rad}(I)$.

Definition 2.52. Let $f = \underline{X}^n \in \llbracket R \rrbracket$. The *support* of f is the set of variables that appear in f :

$$\text{Supp}(f) = \{i \in \{1, \dots, d\} : n_i \geq 1\} = \{i \in \{1, \dots, d\} : X_i \mid f\}.$$

The *reduction* of f is the monomial achieved by reducing all non-zero exponents down to 1:

$$\text{red}(f) = \prod_{i \in \text{Supp}(f)} X_i = \prod_{X_i | f} X_i.$$

Example 2.53. $\text{Supp}(X_1^5 X_3^4) = \{1, 3\}$ and $\text{red}(X_1^5 X_3^4) = X_1 X_3$.

Fact 2.54. [8, Theorem 2.3.7] Assume $I = (S)R$ for some $S \subseteq \llbracket R \rrbracket$, then we have $\text{m-rad}(I) = (\text{red}(s) \mid s \in S)R$.

Example 2.55. The monomial ideal $I := (X^3 Y^2, XY^3, Y^5)R$ in $R := A[X, Y]$ has

$$\text{m-rad}(I) = (\text{red}(X^3 Y^2), \text{red}(XY^3), \text{red}(Y^5))R = (XY, XY, Y)R = (Y)R.$$

If $A = \mathbb{Z}/4\mathbb{Z}$, then $\text{rad}(I) = (2, Y)R \neq \text{m-rad}(I)$.

Definition 2.56. I is *m-reducible* if there exist monomial ideals $J, K \subseteq R$ such that $I = J \cap K$ and $J \neq I$ and $K \neq I$. I is *m-irreducible* if it is not m-reducible and $I \neq R$.

Remark. Fact 2.60 shows when A is a field and $I \neq 0$, we have I is irreducible if and only if I is m-irreducible.

Example 2.57. The monomial ideal $(X^3, X^2 Y^2, Y^4)R$ in $R = A[X, Y]$ is m-reducible because we have $(X^3, Y^2)R \cap (X^2, Y^4)R = (X^3, X^2 Y^2, Y^4)R$, $Y^2 \in (X^3, Y^2)R \setminus (X^3, X^2 Y^2, Y^4)R$ and $X^2 \in (X^2, Y^4)R \setminus (X^3, X^2 Y^2, Y^4)R$.

Fact 2.58. I is m-irreducible if and only if $I \neq R$ and for any monomial ideals $J, K \subseteq R$, if $I = J \cap K$, then $I = J$ or $I = K$.

Fact 2.59. [8, Theorem 3.1.4] A nonzero I is m-irreducible if and only if it is generated by “pure powers”, i.e., if and only if $I = (X_{i_1}^{a_1}, \dots, X_{i_t}^{a_t})R$ for some $t \geq 1$ and $a_i \geq 1$ for $i = 1, \dots, t$.

Fact 2.60. [8, Theorem 3.2.4] Assume A is a field. Then I is irreducible if and only if it is m-irreducible.

Definition 2.61. An *m-irreducible decomposition* of I is an expression $I = \bigcap_{i=1}^n J_i$ with $n \geq 1$ such that monomial ideals $J_1, \dots, J_n \subseteq R$ are m-irreducible.

Example 2.62. The monomial ideal $I = (X^2, XY, Y^3)R$ in $R = A[X, Y]$ has an m-irreducible decomposition $I = (X, Y^3)R \cap (X^2, Y)R$.

Fact 2.63. [8, Theorem 3.3.3] If $I \neq R$, then I has an m-irreducible decomposition.

Definition 2.64. An m-irreducible decomposition $I = \bigcap_{i=1}^n J_i$ is *redundant* if $I = \bigcap_{i \neq k} J_i$ for some $k \in \{1, \dots, n\}$. An m-irreducible decomposition $I = \bigcap_{i=1}^n J_i$ is *irredundant* if it is not redundant, that is, if every $k \in \{1, \dots, n\}$ satisfies $J \neq \bigcap_{i \neq k} J_i$. As $J = \bigcap_{i=1}^n J_i \subseteq \bigcap_{i \neq k} J_i$ holds automatically, the given decomposition is irredundant if and only if every $k \in \{1, \dots, d\}$ satisfies $J \subsetneq \bigcap_{i \neq k} J_i$.

Example 2.65. The m-irreducible decomposition in Example 2.62 is irredundant.

Fact 2.66. [8, Corollary 3.3.8] If $I \neq R$, then I has an irredundant m-irreducible decomposition.

Definition 2.67. A monomial $\underline{X}^{\underline{n}}$ with $\underline{n} \in \mathbb{N}_0^d$ is *square-free* if $n_i = 0$ or 1 for $i = 1, \dots, d$. A monomial ideal I of R is *square-free* if it is generated by square-free monomials.

Fact 2.68. [8, Theorem 3.3.9] If I has two irredundant m-irreducible decompositions $I = \bigcap_{i=1}^n I_i$ and $I = \bigcap_{j=1}^m I_j$, then $n = m$ and there exists $\sigma \in S_m$ such that $I_i = J_{\sigma(i)}$ for $i = 1, \dots, n$, where S_n is the permutation group.

Fact 2.69. [8, Theorem 5.1.2] Let A be a field and I have an m-irreducible decomposition $I = \bigcap_{i=1}^m J_i$. Then $\dim(R/I) = d - n$, where n is the smallest number of generators needed for one of the J_i .

Definition 2.70. A *parameter ideal* in R is an ideal of the form $(X_1^{a_1}, \dots, X_d^{a_d})$ with $a_1, \dots, a_d \geq 1$. For $\underline{X}^{\underline{n}} = X_1^{n_1} \cdots X_d^{n_d} \in \llbracket R \rrbracket$ with $\underline{n} \in \mathbb{N}_0^d$, set

$$P_R(\underline{X}^{\underline{n}}) = (X_1^{n_1+1}, \dots, X_d^{n_d+1})R.$$

Fact 2.71. The parameter ideals of R are exactly the ideals of the form $P_R(f)$.

Definition 2.72. A *parametric decomposition* of I is an m-irreducible decomposition of I of the form $I = \bigcap_{i=1}^n P_R(f_i)$.

A parametric decomposition $I = \bigcap_{i=1}^n P_R(f_i)$ is *irredundant* if $I \neq \bigcap_{i \neq j} P_R(f_i)$ for any $j \in \{1, \dots, n\}$.

A parametric decomposition $I = \bigcap_{i=1}^n P_R(f_i)$ is *redundant* if $I = \bigcap_{i \neq j} P_R(f_i)$ for some $j \in \{1, \dots, n\}$.

Fact 2.73. [8, Theorem 6.1.5 and Exercise 5.1.7] I has a parametric decomposition if and only if $\text{m-rad}(I) = \mathfrak{X}$. Furthermore, if A is a field, then they are equivalent to $\dim(R/I) = 0$.

Definition 2.74. $f \in \llbracket R \rrbracket$ is an I -corner element if $f \notin I$ and $X_1 f, \dots, X_d f \in I$, i.e., $f \notin I$ and $f\mathfrak{X} \subseteq I$. The set of I -corner elements in $\llbracket R \rrbracket$ is denoted $C_R(I)$.

Example 2.75. Let $R = A[X, Y]$. Then $C_R(\mathfrak{X}^3) = \{X^2, XY, Y^2\}$ and $C_R(P_R(Y^2)) = \{Y^2\}$.

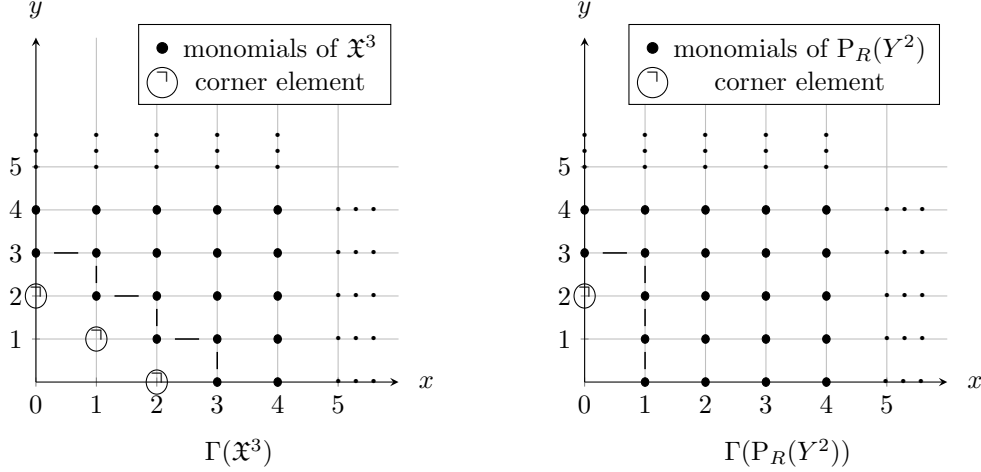

Remark. Corner elements may remind a reader of a border basis, but they are different.

Definition 2.76. Let $J \subseteq R$ be an ideal. Define the *ideal quotient* or *colon ideal* $(I :_R J)$ by

$$(I :_R J) = \{r \in R \mid rj \in I, \forall j \in J\}.$$

Fact 2.77. [8, Theorem 2.5.1] Let $J \subseteq R$ be an ideal. Then $(I :_R J)$ is an ideal of R . Furthermore, if J is also a monomial ideal, then so is $(I :_R J)$.

Fact 2.78. [8, Proposition 6.2.3] We have the following facts:

- (a) $C_R(I) = \llbracket (I :_R \mathfrak{X}) \rrbracket \setminus \llbracket I \rrbracket$.
- (b) If $f, f' \in C_R(I)$ are distinct, then $f \notin (f')R$ and $f' \notin (f)R$.
- (c) $C_R(I)$ is finite.

Proposition 2.79.

$$(I : \mathfrak{X}) = I + (C_R(I))R.$$

Proof. “ \supseteq ”. By definition, $\mathfrak{X} C_R(I) \subseteq I$, i.e., $(I : \mathfrak{X}) \supseteq C_R(I)$, i.e., $(I : \mathfrak{X}) \supseteq (C_R(I))R$. Also, $(I : \mathfrak{X}) \supseteq I$. So $(I : \mathfrak{X}) \supseteq I + (C_R(I))R$.

“ \subseteq ”. Let $f \in \llbracket (I : \mathfrak{X}) \rrbracket$. Then $f\mathfrak{X} \in I$. If $f \in I$, we are done. Assume $f \notin I$. Since $f\mathfrak{X} \in I$, $f \in C_R(I) \subseteq I + (C_R(I))R$. \square

Proposition 2.80. Assume A is a field. If f_1, \dots, f_t are the distinct I -corner elements in R , then $\overline{f_1}, \dots, \overline{f_t}$ is an $A \cong R/\mathfrak{X}$ -basis of $(I : \mathfrak{X})/I$.

Proof. Since $(I : \mathfrak{X}) \subseteq R$ is an ideal, $(I : \mathfrak{X})$ is an R -module. Also, since $\mathfrak{X} \cdot \frac{(I:\mathfrak{X})}{I} = 0$ in R/I , $(I : \mathfrak{X})/I$ is an $R/\mathfrak{X} \cong A$ -vector space.

Let $\overline{f} \in (I : \mathfrak{X})/I$ with $f \in (I : \mathfrak{X})$. Since $C_R(I) = \{f_1, \dots, f_t\}$, by Proposition 2.79, we have $(I : \mathfrak{X}) = I + (f_1, \dots, f_t)R$. So $\overline{f} \in (I : \mathfrak{X})/I = \frac{I + (f_1, \dots, f_t)R}{I} = (f_1, \dots, f_t) \frac{R}{I} = (\overline{f_1}, \dots, \overline{f_t}) \frac{R}{I}$. Also, since $f_1, \dots, f_t \in C_R(I)$, $f_1, \dots, f_t \in (I : \mathfrak{X})$ and then $\overline{f_1}, \dots, \overline{f_t} \in (I : \mathfrak{X})/I$. So there exist $\overline{r_1}, \dots, \overline{r_t} \in R/I$ with $r_1, \dots, r_t \in R$ such that $\overline{f} = \overline{r_1}\overline{f_1} + \dots + \overline{r_t}\overline{f_t}$. So $\overline{f_1}, \dots, \overline{f_t}$ linearly span $(I : \mathfrak{X})/I$ over A .

Assume there exist $\overline{b_1}, \dots, \overline{b_t} \in R/\mathfrak{X}$ with $b_1, \dots, b_t \in R$ such that $\overline{b_1}\overline{f_1} + \dots + \overline{b_t}\overline{f_t} = 0$ in $(I : \mathfrak{X})/I$. If $\overline{b_i} = 0$, assume without loss of generality that $b_i = 0$. If $\overline{b_i} \neq 0$, assume without loss of generality that b_i is a constant. This is allowable because $R/\mathfrak{X} \cong A$. Then in $(I : \mathfrak{X})/I$, $0 = \overline{b_1}\overline{f_1} + \dots + \overline{b_t}\overline{f_t} = \overline{b_1f_1 + \dots + b_tf_t}$. So $b_1f_1 + \dots + b_tf_t \in I$. Hence $f_i \in I$ for all $i \in \{1, \dots, t\}$ such that $b_i \neq 0$ by Fact 2.46. By definition, though, we have $f_i \notin I$ for $i = 1, \dots, t$. Therefore, $b_i = 0$ for $i = 1, \dots, t$. Thus, $\overline{f_1}, \dots, \overline{f_t} \in (I : \mathfrak{X})/I$ are linearly independent over A . \square

Fact 2.81. [8, Theorem 6.2.9] Let $C_R(I) = \{f_1, \dots, f_m\}$. Then $I = \bigcap_{j=1}^m \text{PR}(f_j)$ is an irredundant parametric decomposition.

Fact 2.82. [8, Proposition 6.2.11] Let $f_1, \dots, f_m \in \llbracket R \rrbracket$. Assume $I = \bigcap_{i=1}^m \text{PR}(f_i)$ is an irredundant parametric decomposition of I . Then $C_R(I) = \{f_1, \dots, f_m\}$.

Fact 2.83. [8, Theorem 7.5.1] Let $I = (\underline{X}^{\underline{a}_1}, \dots, \underline{X}^{\underline{a}_n})R$ with $\underline{a}_i = (a_{i,1}, \dots, a_{i,d}) \in \mathbb{N}_0^d$ for $i = 1, \dots, n$. Then

$$I = \bigcap_{i_1=1}^d \dots \bigcap_{i_n=1}^d \left(X_{i_1}^{a_{1,i_1}}, \dots, X_{i_n}^{a_{n,i_n}} \right).$$

Example 2.84. Let $R = A[X_1, X_2]$ and $I = (X_1^2 X_2, X_1 X_3)R$. Then by Fact 2.83,

$$\begin{aligned}
I &= (X_1^2, X_1)R \cap (X_1^2, X_2^0)R \cap (X_1^2, X_3)R \\
&\quad \cap (X_2, X_1)R \cap (X_2, X_2^0)R \cap (X_2, X_3)R \\
&\quad \cap (X_3^0, X_1)R \cap (X_3^0, X_2^0)R \cap (X_3^0, X_3)R \\
&= (X_1)R \cap R \cap (X_1^2, X_3)R \cap (X_1, X_2)R \cap R \cap (X_2, X_3)R \cap R \cap R \\
&= (X_1)R \cap (X_1^2, X_3)R \cap (X_2, X_3)R.
\end{aligned}$$

The polarization of a monomial is a square-free monomial ideal in a new set of variables obtained by turning powers of variables into products of distinct variables. It is constructed as follows.

Definition 2.85. Define the *polarization* of $\underline{X}^{\underline{a}} = X_1^{a_1} \cdots X_d^{a_d} \in \llbracket R \rrbracket$ to be the square-free monomial

$$\mathcal{PO}(\underline{X}^{\underline{a}}) = X_{1,0} \cdots X_{1,a_1-1} \cdots X_{d,1} \cdots X_{d,a_d-1}$$

in the polynomial ring $R' = A[X_{i,j} \mid 1 \leq i \leq d, 0 \leq j \leq a_i - 1]$. Let $I = (\underline{X}^{a_1}, \dots, \underline{X}^{a_n})R$ with $\underline{a}_i = (a_{i,1}, \dots, a_{i,d}) \in \mathbb{N}_0^d$ for $i = 1, \dots, n$. Define the *polarization* of I by

$$\mathcal{PO}(I) = \left(\mathcal{PO}(\underline{X}^{a_1}), \dots, \mathcal{PO}(\underline{X}^{a_n}) \right) R',$$

where R' is the smallest polynomial ring containing $\mathcal{PO}(\underline{X}^{a_1}), \dots, \mathcal{PO}(\underline{X}^{a_n})$.

Remark. Note that by identifying each X_i with $X_{i,0}$, one can regard

$$R' = A[X_{1,0}, \dots, X_{d,0}][X_{i,j} \mid 1 \leq i \leq d, 1 \leq j \leq a_i - 1] = R[X_{i,j} \mid 1 \leq i \leq d, 1 \leq j \leq a_i - 1],$$

which is a ring extension of R .

Example 2.86. Let $R = A[X_1, X_2, X_3]$ and $I = (X_1^2, X_1 X_2, X_2^3)$. Then

$$\mathcal{PO}(I) = (X_{1,0} X_{1,1}, X_{1,0} X_{2,0}, X_{2,0} X_{2,1} X_{2,2}) R',$$

with $R' = A[X_{1,0}, X_{1,1}, X_{2,0}, X_{2,1}, X_{2,2}]$.

Fact 2.87. [5] Let $I = (\underline{X}^{a_1}, \dots, \underline{X}^{a_n})R$. Let $m_j = \max_{1 \leq i \leq n} \{a_{i,j}\}$ for $j = 1, \dots, d$. Then the sequence of elements $Z = \{X_{i,0} - X_{i,k} \mid 1 \leq i \leq d, 1 \leq k \leq m_i - 1\}$ forms a regular sequence on $R'/\mathcal{PO}(I)$ where R' is the smallest polynomial ring containing $\mathcal{PO}(\underline{X}^{a_1}), \dots, \mathcal{PO}(\underline{X}^{a_n})$, and

$$\frac{R}{I} \cong \frac{R'/\mathcal{PO}(I)}{(Z)R'/\mathcal{PO}(I)} \cong \frac{R'}{(\mathcal{PO}(I) + (Z))R'}.$$

Example 2.88. We have

$$\frac{A[X_1, X_2, X_3]}{(X_1^2, X_2^2, X_3^2)} \cong \frac{A[X_1, X_2, X_3, X_{1,1}, X_{2,1}, X_{3,1}]}{(X_1 X_{1,1}, X_2 X_{2,1}, X_3 X_{3,1}) + (X_1 - X_{1,1}, X_2 - X_{2,1}, X_3 - X_{3,1})}.$$

2.6 Homogeneous Cohen-Macaulay Rings

Let A be a field, set $R = A[X_1, \dots, X_d]$ and let $I \subsetneq R$ be an ideal generated by homogeneous polynomials. In this section, we define Cohen-Macaulayness and we see how to compute the type of R/I , when R/I is Cohen-Macaulay.

Remark. The quotient ring R/I behaves analogously with local rings, e.g., every maximal homogeneous regular sequence on R/I has the same length (See Fact 2.90).

We have already defined depth and type in the local setting. Now we define them in the homogeneous setting.

Definition 2.89. The *depth* of R/I is

$$\text{depth}(R/I) = \text{the length of a maximal homogeneous } (R/I)\text{-regular sequence in } \mathfrak{X}.$$

The *type* of R/I is

$$\text{type}(R/I) = \dim_A(\text{Ext}_R^n(A, R/I)),$$

where $n = \text{depth}(R/I)$.

Fact 2.90. [2, Proposition 1.5.15] We have

$$\text{depth}(R/I) = \text{depth}(R_{\mathfrak{X}}/I_{\mathfrak{X}}),$$

and

$$\text{type}(R/I) = \text{type}(R/\mathfrak{I}/I_{\mathfrak{I}}).$$

Fact 2.91. [2, Theorems 1.2.10 and 2.1.2] If $f_1, \dots, f_r \in R$ is a homogeneous regular sequence for R/I , then

$$\text{depth}(R/(I + (f_1, \dots, f_r)R)) = \text{depth}(R/I) - r,$$

and

$$\dim(R/(I + (f_1, \dots, f_r)R)) = \dim(R/I) - r.$$

Cohen-Macaulay rings, defined next, have been shown over and over again in the literature to be extremely nice. See the discussion in [2, p.57] for more about this.

Definition 2.92. The quotient R/I is *Cohen-Macaulay* if $\text{depth}(R/I) = \dim(R/I)$. We say that I is *Cohen-Macaulay* if the quotient R/I is Cohen-Macaulay.

Fact 2.93. We have the following facts:

(a) Let R/I be Cohen-Macaulay. If f_1, \dots, f_n is a maximal homogeneous regular sequence for R/I , then $\dim(R/(I + (f_1, \dots, f_n)R)) = 0$ and $\text{type}(R/I) = \text{type}(R/(I + (f_1, \dots, f_n)R))$.

(b) If I has an irredundant parametric decomposition $I = \bigcap_{i=1}^t Q_i$, then $\text{type}(R/I) = t$.

Proof. (a) Since R/I is Cohen-Macaulay, by Fact 2.91, we have

$$\dim(R/(I + (f_1, \dots, f_n)R)) = \dim(R/I) - n = \dim(R/I) - \text{depth}(R/I) = 0.$$

By [6, Proposition A.6.2], $\text{type}(R/I) = \text{type}(R/(I + (f_1, \dots, f_n)R))$.

(b) By Facts 2.81 and 2.82, we have $|C_R(I)| = t$. Also, $\text{type}(R/I) = \dim_A(\text{Ext}_R^0(A; R/I)) = \dim_A(\text{Hom}_R(A, R/I))$ with $A \cong R/\mathfrak{X}$. So to show $\text{type}(R/I) = t$, it is equivalent to verify $|C_R(I)| = \dim_A(\text{Hom}_R(A, R/I))$. Assume $C_R(I) = \{\underline{X}^{n_1}, \dots, \underline{X}^{n_t}\}$. Define

$$\begin{array}{ccccc} \Phi : C_R(I) & \longrightarrow & \text{Hom}_R(R/\mathfrak{X}, R/I) & & \\ \underline{X}^{n_i} & \longmapsto & \varphi_i : R/\mathfrak{X} & \longrightarrow & R/I \\ & & \bar{r} & \longmapsto & \overline{r\underline{X}^{n_i}} \end{array}$$

We first show that φ_i is well-defined. Let $\bar{r}_1 = \bar{r}_2$ in R/\mathfrak{X} . Then $r_1 - r_2 \in \mathfrak{X}$. Since $\underline{X}^{n_i} \in C_R(I)$, $(r_1 - r_2)\underline{X}^{n_i} \in I$. So $\overline{r_1 \underline{X}^{n_i}} - \overline{r_2 \underline{X}^{n_i}} = \overline{(r_1 - r_2)\underline{X}^{n_i}} = 0$ in R/I . Hence φ_i is well-defined, and it follows readily that Φ is well-defined as well.

Let e_1, \dots, e_t be the standard basis of the vector space $A^t \cong (R/\mathfrak{X})^t$. Define

$$\begin{aligned}\hat{\Phi} : A^t &\longrightarrow \text{Hom}_R(A, R/I) \\ \bar{e}_i &\longmapsto \Phi(\underline{X}^{n_i}) = \varphi_i, \quad \forall i = 1, \dots, t \\ \sum_{i=1}^t \bar{a}_i \bar{e}_i &\longmapsto \sum_{i=1}^t \bar{a}_i \Phi(\underline{X}^{n_i}) = \sum_{i=1}^t \bar{a}_i \varphi_i\end{aligned}$$

By [10, Remark IX.3.4], $\text{Hom}_R(A, R/I)$ is a finite dimensional A -vector space. So by the universal mapping property for A -vector space, $\hat{\Phi}$ is a well-defined A -linear transformation.

Let $x = \sum_{i=1}^t a_i e_i \in A^t$ with $a_1, \dots, a_t \in A$. Then $x \in \text{Ker}(\hat{\Phi})$ if and only if $0 = \hat{\Phi}(x) = \hat{\Phi}(\sum_{i=1}^t a_i e_i) = \sum_{i=1}^t a_i \varphi_i$ if and only if in R/I , $0 = (\sum_{i=1}^t a_i \varphi_i)(\bar{1}) = \sum_{i=1}^t a_i \varphi_i(\bar{1}) = \sum_{i=1}^t a_i \overline{\underline{X}^{n_i}}$ if and only if $a_1 = \dots = a_t = 0$ by Proposition 2.80 if and only if $x = 0$. So $\hat{\Phi}$ is 1-1.

Let $\psi \in \text{Hom}_R(A, R/I)$. If $\psi = 0$, then $\hat{\Phi}(0) = 0 = \psi$ since $\hat{\Phi}$ is a linear transformation. By Dickson's Lemma, we have $I = (f_1, \dots, f_m)R$ for some $f_1, \dots, f_m \in \llbracket R \rrbracket$. Assume $\psi \neq 0$. Since A is a cyclic R -module, there exists $s \in R$ such that

$$\begin{aligned}\psi : A &\rightarrow R/I \\ \bar{1} &\mapsto \bar{s}.\end{aligned}$$

Note that in R/I , $0 = \psi(\mathfrak{X}/\mathfrak{X}) = (s\mathfrak{X} + I)/I$, i.e., $s\mathfrak{X} + I \subseteq I$, so $s\mathfrak{X} \subseteq I$. Hence by Proposition 2.79, $s \in (I : \mathfrak{X}) = I + (C_R(I))R = I + (\underline{X}^{n_1}, \dots, \underline{X}^{n_t})R$. So in R/I , $\bar{s} = \sum_{i=1}^t \overline{b_i \underline{X}^{n_i}}$ for some $b_1, \dots, b_t \in R$. Since $\hat{\Phi}$ is A -linear, for all $\bar{r} \in A$,

$$\begin{aligned}\psi(\bar{r}) &= \bar{s}\bar{r} = \overline{s\bar{r}} = \overline{\left(\sum_{i=1}^t b_i \underline{X}^{n_i}\right)\bar{r}} = \overline{\left(\sum_{i=1}^t \varphi_i(\bar{b}_i)\right)\bar{r}} = \overline{\left(\sum_{i=1}^t \Phi(\underline{X}^{n_i})(\bar{b}_i)\right)\bar{r}} = \overline{\left(\sum_{i=1}^t \hat{\Phi}(\bar{e}_i)(\bar{b}_i)\right)\bar{r}} \\ &= \overline{\left(\sum_{i=1}^t \hat{\Phi}(\bar{b}_i \bar{e}_i)(\bar{1})\right)\bar{r}} = \overline{\left(\hat{\Phi}\left(\sum_{i=1}^t \bar{b}_i \bar{e}_i\right)(\bar{1})\right)\bar{r}} = \overline{\hat{\Phi}\left(\sum_{i=1}^t \bar{b}_i \bar{e}_i\right)(\bar{r})}.\end{aligned}$$

So $\hat{\Phi}\left(\sum_{i=1}^t \bar{b}_i \bar{e}_i\right) = \psi$. Thus, $\hat{\Phi}$ is onto. \square

Chapter 3

Cohen-Macaulay Type of Weighted Edge Ideals and Path Ideals

In Sections 3.2-3.4, we present the main results of this thesis. These results give formulas to compute the type of the edge ideal of a suspension of a graph, the type of the weighted edge ideal of a weighted suspension and the type of the r -path ideal of an r -path suspension of a graph. Section 3.1 contains a little more background needed for these results. Let A be a field and $R = A[X_1, \dots, X_d]$. Let $G = (V, E)$ be a (finite simple) graph with vertex set $V = \{v_1, \dots, v_d\}$ and edge set E . An edge between vertices v_i and v_j is denoted $v_i v_j$.

3.1 Connections Between Combinatorics and Monomial Ideals

In this section, we list some combinatorial facts about square-free monomial ideals.

Definition 3.1. We have the following definitions:

- (a) The *edge ideal* associated to G is the ideal $I(G) \subseteq R$ that is “generated by the edges of G ”:

$$I(G) = (X_i X_j \mid v_i v_j \in E)R.$$

(b) For each $V' \subseteq V$, let $P_{V'} \subseteq R$ be the ideal “generated by the elements of V' ”:

$$P_{V'} = (X_i \mid v_i \in V')R.$$

For instance, $P_V = \mathfrak{X} = (X_1, \dots, X_d)R$.

We use the definitions for paths and cycles from Diestel [3].

Definition 3.2. An r -path is a non-empty graph $P = (V, E)$ of the form $V = \{x_0, \dots, x_r\}$ and $E = \{x_0x_1, x_1x_2, \dots, x_{r-1}x_r\}$, where x_i are all distinct. We denote an r -path by $P_r = (x_0 \text{ --- } x_1 \text{ --- } \dots \text{ --- } x_r)$. Note there is $r + 1$ vertices and r edges in P_r .

If $P_r = (x_0 \text{ --- } x_1 \text{ --- } \dots \text{ --- } x_{r-1})$ is an $(r - 1)$ -path, then the graph $P_{r-1} + x_{r-1}x_r$ is called a *cycle*.

Example 3.3. Consider the following 3-cycle $C_3 = (v_1 \text{ --- } v_2 \text{ --- } v_3 \text{ --- } v_1)$.

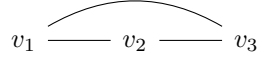

The edge ideal $I(C_3) = (X_1X_2, X_2X_3, X_1X_3)$ in $R = A[X_1, X_2, X_3]$. We have $P_{V'} = (X_1, X_3)R$ for $V' = \{v_1, v_3\}$.

Definition 3.4. A *vertex cover* of G is a subset $V' \subseteq V$ such that for each edge $v_iv_j \in E$ we have $v_i \in V'$ or $v_j \in V'$. A vertex cover V' is *minimal* if it does not properly contain another vertex cover of G .

Example 3.5. The minimal vertex covers for the 2-path $P_2 = (v_1 \text{ --- } v_2 \text{ --- } v_3)$ are depicted in the following sketches.

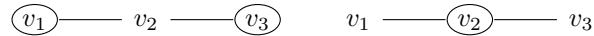

Fact 3.6. [8, Theorem 4.3.6] The ideal $I(G)$ is a square-free monomial ideal. It has the following m -irreducible decomposition

$$I(G) = \bigcap_{V' \text{ v. cover}} P_{V'} = \bigcap_{V' \text{ min. v. cover}} P_{V'},$$

where the first intersection is taken over all vertex covers of G , and the second intersection is taken over all minimal vertex covers of G . The second intersection is irredundant.

Definition 3.7. For $V' \subseteq V$, set

$$\underline{X}^{V'} = \prod_{v_i \in V'} X_i.$$

Definition 3.8. A *simplicial complex* on V is a nonempty collection Δ of subsets of V that is closed under subsets. An element of Δ is called a *face* of Δ . A face of the form $\{v_i\}$ is called a *vertex* of Δ . A face of the form $\{v_j, v_k\}$ with $j \neq k$ is called an *edge* of Δ . A maximal element of Δ with respect to containment is a *facet* of Δ . The $(d-1)$ -*simplex* consists of all the subsets of V and is denoted Δ_{d-1} .

Definition 3.9. Let Δ be a simplicial complex on V . The *Stanley-Reisner ideal* of R associated to Δ is the ideal “generated by the non-faces of Δ ”:

$$J_\Delta = \left(\underline{X}^{V'} \mid V' \subseteq V \text{ and } V' \notin \Delta \right) R.$$

Definition 3.10. $W \subseteq V$ is *independent* in G if for any distinct $x_i, x_j \in W$: x_i is not adjacent to x_j in G . An independent subset in G is *maximal* if it is maximal with respect to containment. Let Δ_G denote the set of independent subsets of G . This is the *independence complex* of G .

Fact 3.11. [8, Theorem 4.4.9] Δ_G is a simplicial complex such that

$$I_G = J_{\Delta_G}.$$

3.2 The Type of $R'/I(\Sigma G)$

In this section, we compute the type of $R'/I(\Sigma G)$ naturally using some known facts. See Formula (*) from the abstract and Theorem 3.20. Let $R' = A[X_1, \dots, X_d, Y_1, \dots, Y_d]$.

Definition 3.12. The *suspension* of G is the graph ΣG with vertex set

$$V(\Sigma G) = V \sqcup \{w_1, \dots, w_d\} = \{v_1, \dots, v_d, w_1, \dots, w_d\}$$

and edge set

$$E(\Sigma G) = E(G) \sqcup \{v_1w_1, \dots, v_dw_d\}.$$

This is also known as the K_1 -corona of G .

Remark. The term “suspension” is due to Villarreal [11]. It is not related to the suspension of a topological space.

Example 3.13. The suspension ΣP_2 of the path $G = P_2 = (v_1 \text{ --- } v_2 \text{ --- } v_3)$ is

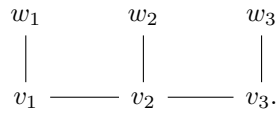

Fact 3.14. The minimal vertex covers of ΣG are of the form $V' \sqcup W'$, where V' is a vertex cover of G and $W' = \{w_i \mid v_i \notin V'\}$. So the size of each minimal vertex cover of ΣG is d .

Example 3.15. Consider the following graph ΣP_2 as in Example 3.13.

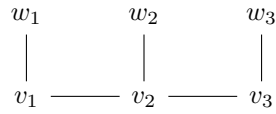

We depict the vertex covers of P_2 in the following sketches.

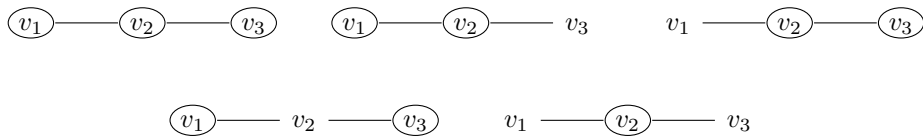

So by Fact 3.14, we present the minimal vertex covers of ΣP_2 in the following sketches.

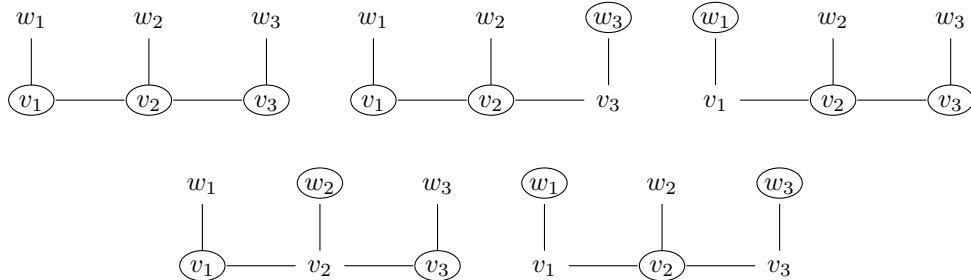

Then by Fact 3.6, the irredundant m-irreducible decomposition of $I(\Sigma P_2)$ is given by

$$\begin{aligned} I(\Sigma P_2) &= (X_1 X_2, X_2 X_3, X_1 Y_1, X_2 Y_2, X_3 Y_3) R' \\ &= (X_1, X_2, X_3) R' \cap (X_1, X_2, Y_3) R' \cap (Y_1, X_2, X_3) R' \cap (X_1, Y_2, X_3) R' \cap (Y_1, X_2, Y_3) R'. \end{aligned}$$

Fact 3.16.

$$\dim\left(\frac{R'}{I(\Sigma G)}\right) = d.$$

Proof. By Facts 3.6, 3.14 and 2.69, $\dim\left(\frac{R'}{I(\Sigma G)}\right) = 2d - d = d$. □

Fact 3.17. Note that $I(\Sigma G)$ is the polarization of $I(G) + (X_1^2, \dots, X_d^2)R$. So by Fact 2.87, the list $X_1 - Y_1, \dots, X_d - Y_d$ is a maximal homogeneous regular sequence for $\frac{R'}{I(\Sigma G)}$ and

$$\frac{R}{I(G) + (X_1^2, \dots, X_d^2)R} \cong \frac{R'}{I(\Sigma G) + (X_1 - Y_1, \dots, X_d - Y_d)R'}.$$

Because of the following fact, the main result of this section gives a formula to compute $\text{type}(R/I(G))$ for all trees such that $R/I(G)$ is Cohen-Macaulay.

Fact 3.18. We have the following facts.

- (a) $R'/I(\Sigma G)$ is Cohen-Macaulay.
- (b) If G is a tree and $R/I(G)$ is Cohen-Macaulay, then $G = \Sigma H$ for some subtree H , in fact, H is the subgraph induced by vertices of degree ≥ 2 .

Proof. (a) By Fact 3.17, $\text{depth}(R'/I(\Sigma G)) = d$. Also, by Fact 3.16, $\dim(R'/I(\Sigma G)) = d$. So $R'/I(\Sigma G)$ is Cohen-Macaulay.

(b) By [11, Theorem 2.4]. □

Example 3.19. We have the following two quotients $R/I(G)$, one of which is Cohen-Macaulay, and the other is not.

(a) Consider the 2-path

$$G := P_2 = (v_1 \text{ --- } v_2 \text{ --- } v_3).$$

Then $I(G) = (X_1 X_2, X_2 X_3)R = (X_1, X_3)R \cap (X_2)R$ by Fact 3.6. So by the fourth isomorphism theorem, we have in $R/I(G)$, $0 = \overline{I(G)} = \overline{(X_1, X_3)R} \cap \overline{(X_2)R}$, which is a minimal primary decomposition.

So the set of associated primes $\text{Ass}_R(0) = \{\text{rad}(\overline{(X_1, X_3)R}), \text{rad}(\overline{(X_2)R})\} = \{\overline{(X_1, X_3)R}, \overline{(X_2)R}\}$. Hence by [1, Proposition 4.7] the set of zero divisors $\text{ZD}(R/I(G))$ of $R/I(G)$ is $\overline{(X_1, X_3)R} \cup \overline{(X_2)R}$. So $\overline{X_2 - X_3}$ is regular in $R/I(G)$. We simplify the quotient $R/(I(G) + (X_2 - X_3)R) \cong R'/(X_1X_2, X_2^2)R'$, where $R' = A[X_1, X_2]$.

By Fact 2.83, $J := (X_1X_2, X_2^2)R' = (X_1, X_2^2)R' \cap (X_2)R'$. As before, $\text{ZD}(R'/J) = \overline{(X_1, X_2)R'}$. Since $\overline{(X_1, X_2)R'}$ is a maximal ideal of R'/J , $\text{depth}(R'/J) = 0$. So $\text{depth}(R/I(G)) = \text{depth}(R'/J) + 1 = 1$ by Fact 2.91. On the other hand, by Fact 2.69, $\dim(R/I(G)) = 3 - 1 = 2$. Hence $R/I(G)$ is not Cohen-Macaulay.

Observe that P_2 is not a suspension of any subtree.

(b) Consider the 3-path

$$G := P_3 = (v_1 \text{ --- } v_2 \text{ --- } v_3 \text{ --- } v_4).$$

Then $I(G) = (X_1X_2, X_2X_3, X_3X_4)R = (X_1, X_3)R \cap (X_2, X_3)R \cap (X_2, X_4)R$ by Fact 3.6. So by the fourth isomorphism theorem, we have in $R/I(G)$, $0 = \overline{I(G)} = \overline{(X_1, X_3)R} \cap \overline{(X_2, X_3)R} \cap \overline{(X_2, X_4)R}$, which is a minimal primary decomposition. As in part (a), we have $\overline{X_3 - X_4}$ is regular in $R/I(G)$. We simplify the quotient $R/(I(G) + (X_3 - X_4)R) \cong R'/(X_1X_2, X_2X_3, X_3^2)R'$, where $R' = A[X_1, X_2, X_3]$.

By Fact 2.83, $J := (X_1X_2, X_2X_3, X_3^2)R' = (X_2, X_3^2)R' \cap (X_1, X_3)R'$. As before, $\overline{X_1 - X_2}$ is regular in R'/J . We simplify the quotient

$$R/(I(G) + (X_3 - X_4, X_1 - X_2)R) \cong R'/(J + (X_1 - X_2)R') \cong R''/(X_2^2, X_2X_3, X_3^2)R'',$$

where $R'' = A[X_2, X_3]$. Let $K = (X_2^2, X_2X_3, X_3^2)R''$. Then $\text{depth}(R''/K) = 0$ as before and so $\text{depth}(R/I(G)) = \text{depth}(R''/K) + 2 = 2$ by Fact 2.91. On the other hand, by Fact 2.69, $\dim(R/I(G)) = 4 - 2 = 2$. Hence $R/I(G)$ is Cohen-Macaulay.

Observe that P_3 is a suspension of the subtree 1-path $(v_2 \text{ --- } v_3)$.

The following theorem is the first main result of this thesis. It is Formula (*) from the abstract.

Theorem 3.20.

$$\text{type}\left(\frac{R'}{I(\Sigma G)}\right) = \# \text{ minimal vertex covers of } G.$$

Proof. We compute

$$\begin{aligned}
\text{type}\left(\frac{R'}{I(\Sigma G)}\right) &= \text{type}\left(\frac{R'}{I(\Sigma G) + (X_1 - Y_1, \dots, X_d - Y_d)R'}\right) \\
&= \text{type}\left(\frac{R}{I(G) + (X_1^2, \dots, X_d^2)R}\right) \\
&= \# \text{ ideals in the irredundant parametric decomposition of } I(G) + (X_1^2, \dots, X_d^2) \\
&= \# \text{ ideals in irredundant m-irreducible decomposition of } I(G) \\
&= \# \text{ minimal vertex covers of } G,
\end{aligned}$$

where the first equality is from Facts 2.93(a), 3.18(a) and 3.17, the second equality is from Fact 3.17, the third equality is from Fact 2.93(b) since $\dim\left(\frac{R}{I(G) + (X_1^2, \dots, X_d^2)R}\right) = 0$, the fourth equality is from [8, Theorem 7.5.3], and the last equality is from Fact 3.6. \square

Remark. Because of Fact 3.18, we can use Theorem 3.20 to compute $\text{type}(R/I(G))$ for all trees G such that $I(G)$ is Cohen-Macaulay.

Example 3.21. Consider the following graph ΣP_2 as in Example 3.13.

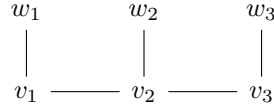

We depict the minimal vertex covers of $G := P_2$ in the following sketches.



By Theorem 3.20,

$$\text{type}(R'/I(\Sigma P_2)) = \# \text{ minimal vertex covers of } P_2 = 2.$$

Since $R'/I(\Sigma P_2)$ is Cohen-Macaulay by Fact 3.18(a), $\text{depth}(R'/I(\Sigma P_2)) = \dim(R'/I(\Sigma P_2)) = 3$ by Fact 3.16. Hence

$$\text{Ext}_{R'}^3(A, R'/I(\Sigma P_2)) \cong A^2.$$

3.3 Weighted Edge Ideals $I(G_\omega)$ and the Type of $R'/I((\Sigma G)_\lambda)$

In this section, we prove a weighted version of Theorem 3.20 based on results from [9]. See Formula (***) from the abstract and Theorem 3.43. Let $R' = A[X_1, \dots, X_d, Y_1, \dots, Y_d]$. Let $\mathbb{N} = \{1, 2, 3, \dots\}$ be the set of positive integers.

Definition 3.22. A *weight function* on a graph G is a function $\omega : E \rightarrow \mathbb{N}$ that assigns a *weight* to each edge. A *weighted graph* G_ω is a graph G equipped with a weight function ω .

Example 3.23. Let $G := P_2 = (v_1 \text{ --- } v_2 \text{ --- } v_3)$. We assign a weight to each edge of ΣG , then we get, e.g., the following weighted graph $(\Sigma G)_\omega$.

$$\begin{array}{ccccc} w_1 & & w_2 & & w_3 \\ | & & | & & | \\ 5 & & 3 & & 4 \\ v_1 & \xrightarrow{2} & v_2 & \xrightarrow{3} & v_3 \end{array}$$

Definition 3.24. Let Ω consist of the pairs (V', δ') with $V' \subseteq V$ and $\delta' : V' \rightarrow \mathbb{N}$.

Definition 3.25. We have the following definitions:

(a) The *weighted edge ideal* associated to G_ω is the ideal $I(G_\omega) \subseteq R$ that is “generated by the weighted edges of G ”:

$$I(G_\omega) = \left(X_i^{\omega(v_i v_j)} X_j^{\omega(v_i v_j)} \mid v_i v_j \in E \right) R.$$

(b) Let $P(V', \delta') \subseteq R$ be the ideal “generated by the elements of (V', δ') ”:

$$P(V', \delta') = \left(X_i^{\delta'(v_i)} \mid v_i \in V' \right) R.$$

Example 3.26. Consider the following graph $(\Sigma P_2)_\omega$ as in Example 3.23.

$$\begin{array}{ccccc} w_1 & & w_2 & & w_3 \\ | & & | & & | \\ 5 & & 3 & & 4 \\ v_1 & \xrightarrow{2} & v_2 & \xrightarrow{3} & v_3 \end{array}$$

The weighted edge ideal associated to $(\Sigma P_2)_\omega$ is

$$I((\Sigma P_2)_\omega) = (X_1^2 X_2^2, X_2^3 X_3^3, X_1^5 Y_1^5, X_2^3 Y_2^3, X_3^4 Y_3^4) R'.$$

Let $V' = \{v_1, w_2, v_3\}$ and $\delta' : V' \rightarrow \mathbb{N}$ is defined by $v_1 \mapsto 3$, $w_2 \mapsto 2$ and $v_3 \mapsto 4$. Then

$$P(V', \delta') = (X_1^3, Y_2^2, X_3^4).$$

Definition 3.27. A *weighted vertex cover* of G_ω is an ordered pair $(V', \delta') \in \Omega$ such that V' is a vertex cover of G and for each edge $v_i v_j \in E$, we have

- (a) $v_i \in V'$ and $\delta'(v_i) \leq \omega(v_i v_j)$, or
- (b) $v_j \in V'$ and $\delta'(v_j) \leq \omega(v_i v_j)$.

The number $\delta'(v_i)$ is the *weight* of v_i .

Remark. For each weighted vertex cover (V', δ') of G_ω , we also use $\{v_i^{\delta'(v_i)} \mid v_i \in V'\}$ to denote it, especially when we depict weighted vertex covers of G_ω in sketches.

Definition 3.28. Given two weighted vertex covers (V'_1, δ'_1) and (V'_2, δ'_2) of G_ω , we write $(V'_2, \delta'_2) \leq (V'_1, \delta'_1)$ if $V'_2 \subseteq V'_1$ and $\delta'_2(v_i) \geq \delta'_1(v_i)$ for all $v_i \in V'_2$. A weighted vertex cover (V', δ') is *minimal* if there does not exist another weighted vertex cover (V'', δ'') such that $(V'', \delta'') < (V', \delta')$. We define $|(V', \delta')| = |V'|$.

Example 3.29. The minimal weighted vertex covers of H_ω as in Example 3.23 are displayed in the following sketches.

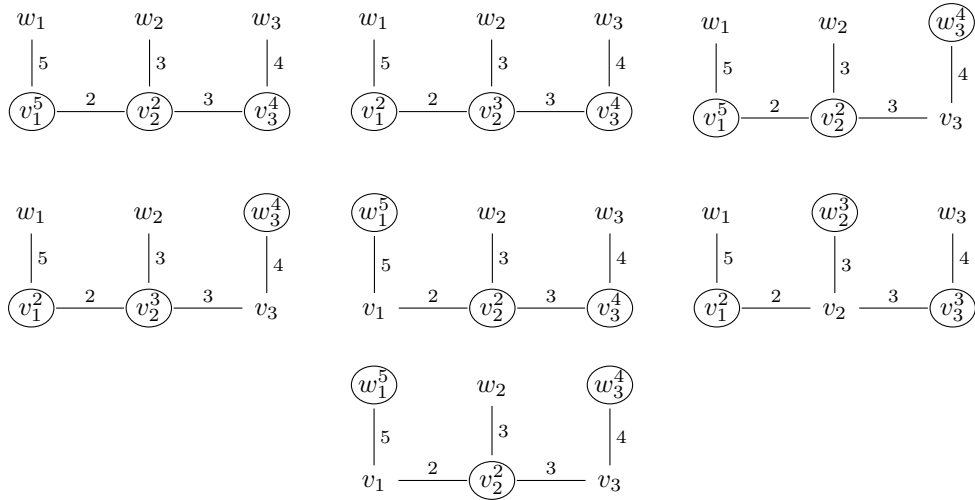

Fact 3.30. [9, Theorem 3.5]

$$I(G_\omega) = \bigcap_{(V', \delta') \text{ w. v. cover}} P(V', \delta') = \bigcap_{(V', \delta') \text{ min. w. v. cover}} P(V', \delta'),$$

where the first intersection is taken over all weighted vertex covers of G_ω , and the second intersection is taken over all minimal weighted vertex covers of G_ω . The second intersection is irredundant.

Example 3.31. Consider the following graph $(\Sigma P_2)_\omega$ as in Example 3.23.

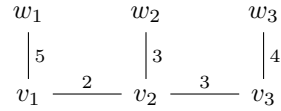

Then by Fact 3.30 and Example 3.29, the irredundant m-irreducible decomposition of $I((\Sigma P_2)_\omega)$ is given by

$$\begin{aligned} I((\Sigma P_2)_\omega) = & (X_1^5, X_2^2, X_3^4)R' \cap (X_1^2, X_2^3, X_3^4)R' \cap (X_1^5, X_2^2, Y_3^4)R' \cap (X_1^2, X_2^3, Y_3^4)R' \\ & \cap (Y_1^5, X_2^2, X_3^4)R' \cap (X_1^2, Y_2^3, X_3^3)R' \cap (Y_1^5, X_2^2, Y_3^4)R'. \end{aligned}$$

Notation 3.32. For $(V', \delta') \in \Omega$, set

$$\underline{X}^{(V', \delta')} = \prod_{v_i \in V'} X_i^{\delta'(v_i)}.$$

Definition 3.33. $(V', \delta') \in \Omega$ is said to be *weighted-independent* in G_ω if V' is independent in G , or for any adjacent $v_i, v_j \in V'$, we have $\delta'(v_i) < \omega(v_i v_j)$ or $\delta'(v_j) < \omega(v_i v_j)$. Let Δ_{G_ω} denote the set of weighted-independent subsets $(V', \delta') \in \Omega$ in G_ω .

Example 3.34. Consider the following weighted 2-path $(P_2)_\omega$.

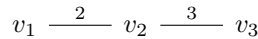

Then $\{v_1^{10}, v_3^{10}\}$ is weighted-independent in $(P_2)_\omega$ since $\{v_1, v_3\}$ is independent in P_2 , and $\{v_1^1, v_2^2\}$ is weighted-independent in $(P_2)_\omega$ since $\delta'(v_1) = 1 < 2 = \omega(v_1 v_2)$ and $\delta'(v_2) = 2 < 3 = \omega(v_2 v_3)$.

Lemma 3.35. Let $(V', \delta') \in \Omega$. If $\underline{X}^{(V', \delta')} \in I(G_\omega)$, then $\underline{X}^{V'} \in I(G)$.

Proof. Since $\underline{X}^{(V', \delta')} \in I(G_\omega)$, there exists $v_i v_j \in E$ such that $X_i^{\omega(v_i v_j)} X_j^{\omega(v_i v_j)} \mid \underline{X}^{(V', \delta')}$. Since $v_i v_j \in E$, we have $X_i X_j \in I(G)$. Since $\omega(v_i v_j) \geq 1$, we have $v_i, v_j \in V'$, i.e., $X_i X_j \mid \underline{X}^{V'}$. So $\underline{X}^{V'} \in I(G)$. \square

Theorem 3.36. *Let $(V', \delta') \in \Omega$. Then $(V', \delta') \in \Delta_{G_\omega}$ if and only if $\underline{X}^{(V', \delta')} \notin I(G_\omega)$.*

Proof. “ \Rightarrow ”. Assume $(V', \delta') \in \Delta_{G_\omega}$. First, we assume V' is independent in G , i.e., $V' \in \Delta_G$. Suppose $\underline{X}^{V'} \in J_{\Delta_G}$, where J_{Δ_G} is the Stanley-Reisner ideal of R associated to the independence complex Δ_G . Then there exists $V'' \subseteq V$ and $V'' \notin \Delta_G$ such that $\underline{X}^{V''} \mid \underline{X}^{V'}$, so $V'' \subseteq V'$, contradicting the fact that Δ_G is a simplicial complex and $V' \in \Delta_G$. Hence $\underline{X}^{V'} \notin J_{\Delta_G} = I(G)$ by Fact 3.11. Thus, $\underline{X}^{(V', \delta')} \notin I(G_\omega)$ by Lemma 3.35. Assume now V' is dependent in G . Fix an adjacent $v_i, v_j \in V'$. Then $\delta'(v_i) < \omega(v_i v_j)$ or $\delta'(v_j) < \omega(v_i v_j)$, so $X_i^{\omega(v_i v_j)} X_j^{\omega(v_i v_j)} \nmid X_i^{\delta'(v_i)} X_j^{\delta'(v_j)}$, hence $X_i^{\omega(v_i v_j)} X_j^{\omega(v_i v_j)} \nmid \underline{X}^{(V', \delta')}$. Since the adjacent $v_i, v_j \in V'$ are arbitrary, $\underline{X}^{(V', \delta')} \notin I(G_\omega)$.

“ \Leftarrow ”. Assume $\underline{X}^{(V', \delta')} \notin I(G_\omega)$. If V' is independent in G , we are done. Assume V' is dependent in G . Then we can fix adjacent $v_i, v_j \in V'$. Since $\underline{X}^{(V', \delta')} \notin I(G_\omega)$, we have $X_i^{\omega(v_i v_j)} X_j^{\omega(v_i v_j)} \nmid \underline{X}^{(V', \delta')}$, i.e., $\delta'(v_i) < \omega(v_i v_j)$ or $\delta'(v_j) < \omega(v_i v_j)$. Since the adjacent $v_i, v_j \in V'$ are arbitrary, (V', δ') is weighted-independent in G_ω , i.e., $(V', \delta') \in \Delta_{G_\omega}$. \square

Definition 3.37.

$$J_{\Delta_{G_\omega}} = \left(\underline{X}^{(V', \delta')} \mid (V', \delta') \in \Omega \setminus \Delta_{G_\omega} \right) R.$$

Theorem 3.38.

$$I(G_\omega) = J_{\Delta_{G_\omega}}.$$

Proof. “ \supseteq ”. Let $\underline{X}^{(V', \delta')} \in J_{\Delta_{G_\omega}}$ be a generator. Then $(V', \delta') \in \Omega \setminus \Delta_{G_\omega}$. So $\underline{X}^{(V', \delta')} \in I(G_\omega)$ by Theorem 3.36.

“ \subseteq ”. Let $X_i^{\omega(v_i v_j)} X_j^{\omega(v_i v_j)} \in I(G_\omega)$ with $v_i v_j \in E$. Let $V' = \{v_i, v_j\}$ and define $\delta' : V' \rightarrow \mathbb{N}$ by $\delta'(v_i) = \omega(v_i v_j) = \delta'(v_j)$. Then $(V', \delta') \in \Omega$ and $\underline{X}^{(V', \delta')} = X_i^{\omega(v_i v_j)} X_j^{\omega(v_i v_j)} \in I(G_\omega)$. So $(V', \delta') \in \Omega \setminus \Delta_{G_\omega}$ by Theorem 3.36. Hence $X_i^{\omega(v_i v_j)} X_j^{\omega(v_i v_j)} = \underline{X}^{(V', \delta')} \in J_{\Delta_G}$. \square

Definition 3.39. A *weighted suspension* of G_ω is a weighted graph $(\Sigma G)_\lambda$ with weight function $\lambda : \Sigma G \rightarrow \mathbb{N}$ such that the underlying graph ΣG is a suspension of G and $\lambda(v_i v_j) = \omega(v_i v_j)$ for all

$v_i v_j \in E(G)$, i.e., $\lambda|_{E(G)} = \omega$. Graphically, $(\Sigma G)_\lambda$ has the form

$$\begin{array}{ccccccc} \cdots & & w_i & & w_j & & w_k & & \cdots \\ & & \left| \lambda(v_i w_i) \right. & & \left| \lambda(v_j w_j) \right. & & \left| \lambda(v_k w_k) \right. & & \\ \cdots & \text{---} & v_i & \xrightarrow{\omega(v_i v_j)} & v_j & \xrightarrow{\omega(v_j v_k)} & v_k & \text{---} & \cdots \end{array}$$

Fact 3.40. Let $(\Sigma G)_\lambda$ be a weighted suspension of G_ω such that $\lambda(v_i v_j) \leq \lambda(v_i w_i)$ and $\lambda(v_i v_j) \leq \lambda(w_j v_j)$ for each $v_i v_j \in E$. Then by [9, Lemma 5.3], $I((\Sigma G)_\lambda)$ is the polarization of $I(G_\omega) + (X_1^{2\lambda(v_1 w_1)}, \dots, X_d^{2\lambda(v_d w_d)})R$. So by Fact 2.87, the list $X_1 - Y_1, \dots, X_d - Y_d$ is a maximal regular sequence for $\frac{R'}{I((\Sigma G)_\lambda)}$ and

$$\frac{R}{I(G_\omega) + (X_1^{2\lambda(v_1 w_1)}, \dots, X_d^{2\lambda(v_d w_d)})R} \cong \frac{R'}{I((\Sigma G)_\lambda) + \{X_1 - Y_1, \dots, X_d - Y_d\}R'}.$$

Because of the following fact, the main result of this section gives a formula to compute $\text{type}(R/I(G_\omega))$ for all weighted trees such that $R/I(G_\omega)$ is Cohen-Macaulay.

Fact 3.41. [9, Theorems 5.7 and 5.10] Let $(\Sigma G)_\lambda$ be a weighted suspension of G_ω such that $\lambda(v_i v_j) \leq \lambda(v_i w_i)$ and $\lambda(v_i v_j) \leq \lambda(w_j v_j)$ for each $v_i v_j \in E$.

- (a) $R'/I((\Sigma G)_\lambda)$ is Cohen-Macaulay.
- (b) If $T_{\lambda'}$ is a weighted tree and $R/I(T_{\lambda'})$ is Cohen-Macaulay, then $T_{\lambda'} = (\Sigma H)_{\lambda'}$ for some weighted subtree $H_{\omega'}$ and the weight function λ' satisfies the above condition.

Example 3.42. Consider the following weighted 3-path.

$$G_\lambda := (P_3)_\lambda = (v_1 \xrightarrow{1} v_2 \xrightarrow{2} v_3 \xrightarrow{2} v_4)$$

Then $I(G_\lambda) = (X_1 X_2, X_2^2 X_3^2, X_3^2 X_4^2)R = (X_1, X_3^2)R \cap (X_2, X_3^2)R \cap (X_1, X_2^2, X_4^2)R \cap (X_2, X_4^2)R$ by Fact 3.30. As in Example 3.19, $\overline{X_3 - X_4}$ is regular in $R/I(G_\lambda)$. We simplify the quotient $R/(I(G_\lambda) + (X_3 - X_4)R) \cong R'/(X_1 X_2, X_2^2 X_3^2, X_3^4)R'$, where $R' = A[X_1, X_2, X_3]$.

By Fact 2.83, $J := (X_1 X_3, X_2^2 X_3^2, X_3^4)R' = (X_1, X_2^2, X_3^4)R' \cap (X_2, X_3^4) \cap (X_1, X_3^2)R'$. Since $\overline{(X_1, X_2, X_3)R'}$ is a maximal ideal of R'/J , $\text{depth}(R/I(G_\lambda)) = 1$ as in Example 3.19. On the other hand, by Fact 2.69, $\dim(R/I(G_\lambda)) = 4 - 2 = 2$. Hence $R/I(G_\lambda)$ is not Cohen-Macaulay.

Observe that $(G)_\lambda$ is a weighted suspension of $P_1 = (v_2 \text{ --- } v_3)$, i.e., $(P_3)_\lambda = (\Sigma P_1)_\lambda$ with $(P_1)_\omega = (v_2 \xrightarrow{2} v_3)$, but we have $\lambda(v_2 v_3) > \lambda(v_1 v_2)$.

The following theorem is the second main result of this thesis. It is Formula (***) from the abstract.

Theorem 3.43. *Let $(\Sigma G)_\lambda$ be a weighted suspension of G_ω such that $\lambda(v_i v_j) \leq \lambda(v_i w_i)$ and $\lambda(v_i v_j) \leq \lambda(w_j v_j)$ for each $v_i v_j \in E$. Then*

$$\text{type}\left(\frac{R'}{I((\Sigma G)_\lambda)}\right) = \# \text{ minimal weighted vertex covers of } G_\omega.$$

Proof. We compute

$$\begin{aligned} \text{type}\left(\frac{R'}{I((\Sigma G)_\lambda)}\right) &= \text{type}\left(\frac{R'}{I((\Sigma G)_\lambda) + (X_1 - Y_1, \dots, X_d - Y_d)R'}\right) \\ &= \text{type}\left(\frac{R}{I(G_\omega) + (X_1^{2\lambda(v_1 w_1)}, \dots, X_d^{2\lambda(v_d w_d)})R}\right) \\ &= \# \text{ ideals in the irredundant parametric decomposition of} \\ &\quad I(G_\omega) + (X_1^{2\lambda(v_1 w_1)}, \dots, X_d^{2\lambda(v_d w_d)}) \\ &= \# \text{ ideals in the irredundant m-irreducible decomposition of } I(G_\omega) \\ &= \# \text{ minimal weighted vertex covers of } G_\omega, \end{aligned}$$

where the first equality is from Facts 2.93(a), 3.41(a) and 3.40, the second equality is from Fact 3.40, the third equality is from Fact 2.93(b) since $\dim\left(\frac{R}{I(G_\omega) + (X_1^{2\lambda(v_1 w_1)}, \dots, X_d^{2\lambda(v_d w_d)})R}\right) = 0$, the fourth equality is from [8, Exercise 7.5.10], and the last equality is from Fact 3.30. \square

Remark. Because of Fact 3.41, we can use Theorem 3.43 to compute $\text{type}(R/I(G_\omega))$ for all weighted trees G_ω such that $I(G_\omega)$ is Cohen-Macaulay.

Example 3.44. Consider the following weighted graph $(\Sigma P_2)_\lambda$ as in Example 3.23.

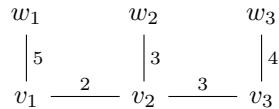

The minimal weighted vertex covers of $(P_2)_\omega = (v_1 \xrightarrow{2} v_2 \xrightarrow{3} v_3)$ are displayed in the following sketches.



Since the weights in $(\Sigma P_2)_\lambda$ satisfy the conditions in Fact 3.41(a) and Theorem 3.43, the ring $R'/I((\Sigma P_2)_\lambda)$ is Cohen-Macaulay and

$$\text{type}(R'/I((\Sigma P_2)_\lambda)) = \# \text{ minimal weighted vertex covers of } (P_2)_\omega = 3.$$

We observe that the smallest number of vertices for one of the weighted vertex covers of $(\Sigma P_2)_\lambda$ is 3. Then by Facts 3.30 and 2.69, $\dim((R'/I((\Sigma P_2)_\lambda)) = 6 - 3 = 3$. Since $R'/I((\Sigma P_2)_\lambda)$ is Cohen-Macaulay by Fact 3.41(a), $\text{depth}(R'/I((\Sigma P_2)_\lambda)) = \dim(R'/I((\Sigma P_2)_\lambda)) = 3$. Hence

$$\text{Ext}_{R'}^3(A, R'/I((\Sigma P_2)_\lambda)) \cong A^3.$$

3.4 Path Ideals and the Type of $R'/I_r(\Sigma_r G)$

In this section, we prove a path-version of Theorem 3.20. See Formula (***) from the abstract and Theorem 3.71. Let r be a positive integer, $\mathfrak{X} = (X_1, \dots, X_d)R$ and $R' = A[\{X_{i,j} \mid i = 1, \dots, d, j = 0, \dots, r\}]$.

Definition 3.45. The r -path suspension of G is the graph $\Sigma_r G$ obtained by adding a new path of length r to each vertex of G such that the vertex set

$$V(\Sigma_r G) = \{v_{i,j} \mid i = 1, \dots, d, j = 0, \dots, r\} \text{ with } v_{i,0} = v_i, \forall i = 1, \dots, d.$$

The new r -paths are called r -whiskers.

Example 3.46. The 2-path suspension $\Sigma_2 P_2$ of the path $G = P_2 = (v_1 \text{ --- } v_2 \text{ --- } v_3)$ is

$$\begin{array}{ccccc} v_{1,2} & & v_{2,2} & & v_{3,2} \\ | & & | & & | \\ v_{1,1} & & v_{2,1} & & v_{3,1} \\ | & & | & & | \\ v_1 & \text{---} & v_2 & \text{---} & v_3. \end{array}$$

Definition 3.47. The r -path ideal associated to G is the ideal $I_r(G) \subseteq R$ that is “generated by the

paths in G of length r :

$$I_r(G) = (X_{i_1} \cdots X_{i_{r+1}} \mid v_{i_1} \cdots v_{i_{r+1}} \text{ is a path in } G)R'.$$

Remark. $I_1(G) = I(G)$.

Example 3.48. Consider the following graph $\Sigma_2 P_2$ as in Example 3.46.

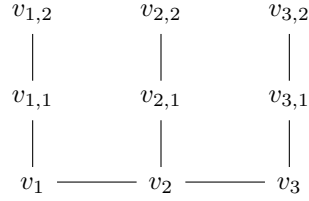

Then the 2-path ideal of $\Sigma_2 P_2$ is

$$\begin{aligned}
 I_2(\Sigma_2 P_2) = & (X_{1,2}X_{1,1}X_1, X_{1,1}X_1X_2, X_1X_2X_3, X_1X_2X_{2,1}, X_2X_{2,1}X_{2,2}, \\
 & X_2X_3X_{3,1}, X_{2,1}X_2X_3, X_3X_{3,1}X_{3,2}) R'.
 \end{aligned}$$

Definition 3.49. An r -path vertex cover of G is a subset $V' \subseteq V$ such that for any r -path $v_{i_1} \cdots v_{i_{r+1}}$ in G , we have $v_{i_j} \in V'$ for some $j \in \{1, \dots, r+1\}$. An r -path vertex cover V' is *minimal* if it does not properly contain another r -path vertex cover of G .

Example 3.50. Consider the following graph $\Sigma_2 P_2$ as in Example 3.46.

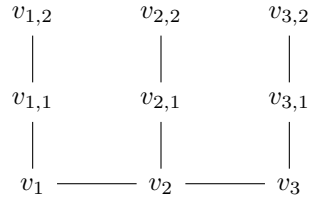

We depict the minimal 2-path vertex covers of $\Sigma_2 P_2$ in the following sketches.

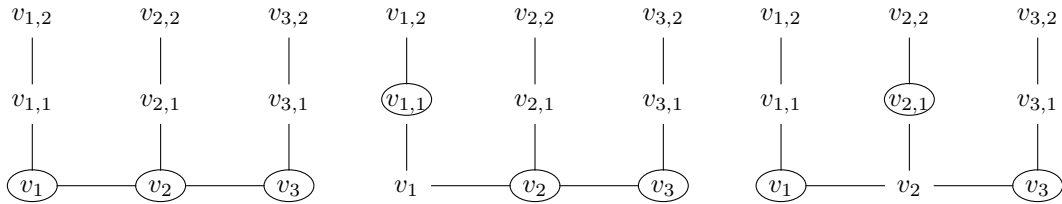

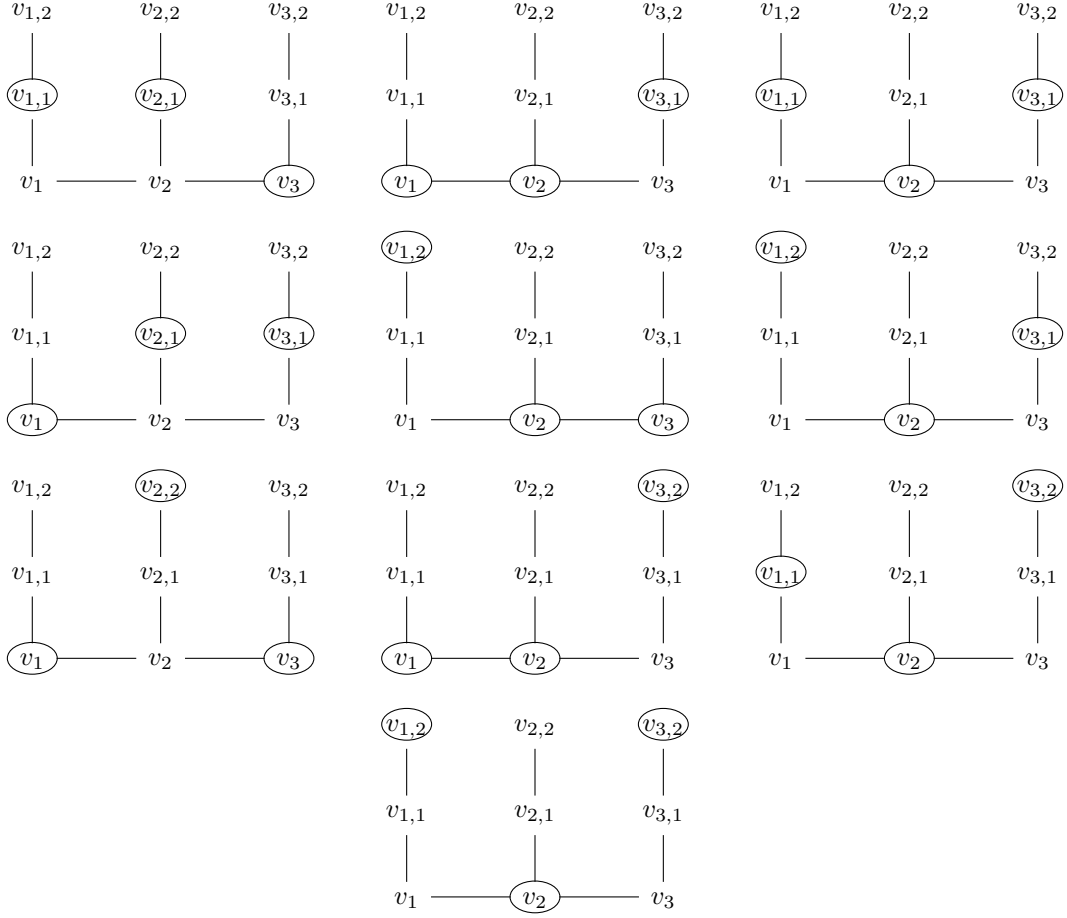

Based on the convention that $v_{i,0} = v_i$ for $i = 1, \dots, d$, we have $X_{i,0} = X_i$ for $i = 1, \dots, d$.

Definition 3.51. Define $p : R' \rightarrow R$ by the formula $p(X_{i,j}) = X_i$. Let $I \subseteq R'$ be a monomial ideal and set

$$IR = p(I)R = (X_{i_1}^{a_1} \cdots X_{i_n}^{a_n} \in R \mid \exists X_{i_1, j_1}^{a_1} \cdots X_{i_n, j_n}^{a_n} \in [I])R.$$

In words, IR is the monomial ideal of R obtained by setting $X_{i,j} = X_i$ for all i, j . It is straightforward to show that if f_1, \dots, f_m is a monomial generating sequence for I , then $p(f_1), \dots, p(f_m)$ is a monomial generating sequence for IR .

Example 3.52. Consider the 2-path ideal $I_2(\Sigma_2 P_2)$ from Example 3.48. Then

$$I_2(\Sigma_2 P_2)R = (X_1^3, X_1^2 X_2, X_1 X_2 X_3, X_1 X_2^2, X_2^3, X_2 X_3^2, X_2^2 X_3, X_3^3)R.$$

Definition 3.53. Let $I \subseteq R$ be an ideal. For $k = 1, 2, \dots$, the k^{th} bracket power of I is the ideal

$I^{[k]} = (T_k)R$, where $T_k = \{f^k \mid f \in \llbracket I \rrbracket\}$.

Fact 3.54. We have $I_r(\Sigma_r G)$ is the polarization of $I_r(\Sigma_r G)R$ by e.g., [7, Proposition 3.7]. So by Proposition 2.87, the list $X_i - X_{i,k}$, $1 \leq i \leq d$, $1 \leq k \leq r$ is a maximal homogeneous regular sequence for $\frac{R'}{I_r(\Sigma_r G)}$ and

$$\frac{R}{I_r(\Sigma_r G)R} \cong \frac{R'}{I_r(\Sigma_r G) + (X_i - X_{i,k} \mid 1 \leq i \leq d, 1 \leq k \leq r)R'}.$$

Furthermore, it is straightforward to show that

$$I_r(\Sigma_r G)R = I_r(\Sigma_{r-1} G)R + \mathfrak{X}^{[r+1]},$$

where $\mathfrak{X} = (X_1, \dots, X_d)R$.

Example 3.55. By definition, the polarization of $I_2(\Sigma_2 P_2)R$ from Example 3.52 is

$$\begin{aligned} \mathcal{PO}(I_2(\Sigma_2 P_2)R) &= \mathcal{PO}((X_1^3, X_1^2 X_2, X_1 X_2 X_3, X_1 X_2^2, X_2^3, X_2 X_3^2, X_2^2 X_3, X_3^3)R) \\ &= (X_1 X_{1,1} X_{1,2}, X_1 X_{1,1} X_2, X_1 X_2 X_3, X_1 X_2 X_{2,1}, X_2 X_{2,1} X_{2,2}, \\ &\quad X_2 X_3 X_{3,1}, X_2 X_{2,1} X_3, X_3 X_{3,1} X_{3,2})R' \\ &= I_2(\Sigma_2 P_2), \end{aligned}$$

where the last equality is from Example 3.48. Note that

$$\begin{aligned} I_2(\Sigma P_2)R + \mathfrak{X}^{[r+1]} &= (X_{1,1} X_1 X_2, X_1 X_2 X_3, X_1 X_2 X_{2,1}, X_2 X_3 X_{3,1}, X_{2,1} X_2 X_3)R \\ &\quad + (X_1^3, X_2^3, X_3^3)R \\ &= (X_1^2 X_2, X_1 X_2 X_3, X_1 X_2^2, X_2 X_3^2, X_2^2 X_3)R + (X_1^3, X_2^3, X_3^3)R \\ &= (X_1^2 X_2, X_1 X_2 X_3, X_1 X_2^2, X_2 X_3^2, X_2^2 X_3, X_1^3, X_2^3, X_3^3)R \\ &= I_2(\Sigma_2 P_2)R, \end{aligned}$$

where the last equality is from Example 3.52.

Definition 3.56. Let v_i be a vertex of degree 1 in G that is not a part of any r -path in G . We write that v_i is an r -pathless leaf of G . Let H be the subgraph of G induced by the vertex subset

$V \setminus \{v_i\}$. We write that H is obtained by *pruning* an r -pathless leaf from G . A subgraph T of G is obtained by *pruning a sequence of r -pathless leaves* from G if there exists a sequence of graphs $G = G_0, G_1, \dots, G_l = T$ such that each G_{i+1} is obtained by pruning an r -pathless leaf from G_i .

Example 3.57. The vertex v_6 in the following tree G is an 4-pathless leaf, because v_6 is not part of any 4-path in G .

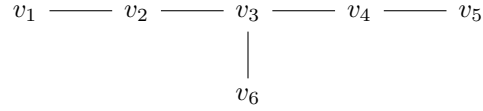

Pruning this leaf yields the following 4-path, which has no 4-pathless leaves.

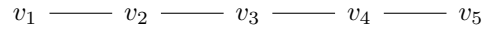

Because of the following fact, the main result of this section gives a formula to compute $\text{type}(R/I_r(G))$ for all trees such that $R/I_r(G)$ is Cohen-Macaulay.

Fact 3.58. [7, Proposition 3.7 and Theorem 3.11] We have the following facts:

- (a) $R'/I_r(\Sigma_r G)$ is Cohen-Macaulay.
- (b) If G is a tree and $R/I_r(G)$ is Cohen-Macaulay, then there exists a subtree H such that $\Sigma_r H$ is obtained by pruning a sequence of r -pathless leaves from G .

Example 3.59. Consider the following tree G as in Example 3.57.

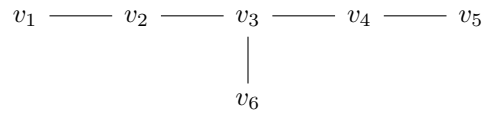

Then $I_4(G) = (X_1 X_2 X_3 X_4 X_5)R$. As in Example 3.19, $\overline{X_4 - X_5}, \overline{X_3 - X_4}, \overline{X_2 - X_3}, \overline{X_1 - X_2}$ is a (maximal) regular sequence in $R/I_4(G)$. We simplify the quotient

$$R/(I_4(G) + (X_4 - X_5, X_3 - X_4, X_2 - X_3, X_1 - X_2)R) \cong R'/(X_1^5)R',$$

where $R' = A[X_1]$. Since $\overline{X_1}$ is a maximal ideal of $R'/(X_1^5)R$, $\text{depth}(R/I_4(G)) = 4$. On the other hand, by Fact 2.69, $\dim(R/I(G)) = 5 - 1 = 4$. Hence $R/I(G)$ is Cohen-Macaulay.

Observe that there exists a subtree v_1 of G such that $\Sigma_4 v_1$ is obtained by pruning a 4-pathless

leaf v_6 from G :

$$\Sigma_4 v_1 : v_1 \text{ --- } v_2 \text{ --- } v_3 \text{ --- } v_4 \text{ --- } v_5$$

Fact 3.60. [7, Lemma 1.11] For every r -path vertex cover V' of G , there is a minimal r -path vertex cover W' of G such that $W' \subseteq V'$.

The main result of this section gives formulas to compute the type of $R'/I_r(\Sigma_r G)$ in terms of minimal r -path vertex covers of $\Sigma_{r-1}G$. Compare this to Theorem 3.20 (the case $r = 1$). Thus, we study $\Sigma_{r-1}G$ before our main theorem.

Definition 3.61. Define $q : V(\Sigma_{r-1}G) \rightarrow V(G)$ as $q(v_{i,j}) = v_i$. Let $V'' \subseteq V(\Sigma_{r-1}G)$. Then

$$q(V'') = \{v_i \mid \exists v_{i,j} \in V''\},$$

and we set

$$\begin{aligned} \gamma_{V''} : q(V'') &\rightarrow \mathbb{N} \\ v_i &\mapsto 1 + \min\{j \mid v_{i,j} \in V''\}. \end{aligned}$$

Example 3.62. Consider the following graph $\Sigma_2 P_2$ as in Example 3.46.

$$\begin{array}{ccccc} v_{1,2} & & v_{2,2} & & v_{3,2} \\ | & & | & & | \\ v_{1,1} & & v_{2,1} & & v_{3,1} \\ | & & | & & | \\ v_1 & \text{---} & v_2 & \text{---} & v_3 \end{array}$$

Then $V'' = \{v_1, v_{2,1}, v_{3,2}, v_3\}$ is a 2-path vertex cover of $\Sigma_2 P_2$. We have $q(V'') = \{v_1, v_2, v_3\}$, $\gamma_{V''}(v_1) = 1$, $\gamma_{V''}(v_2) = 2$ and $\gamma_{V''}(v_3) = 1$.

The following theorem is a key for decomposing $I_r(\Sigma_{r-1}G)R$ and hence $I_r(\Sigma_r G)R$. The proof is somewhat technical. The reader may wish to follow the argument with the preceding example.

Theorem 3.63. *Let $V'' \subseteq V(\Sigma_{r-1}G)$. Then $I_r(\Sigma_{r-1}G)R \subseteq P(q(V''), \gamma_{V''})$ if and only if V'' is an r -path vertex cover of $\Sigma_{r-1}G$.*

Proof. “ \Rightarrow ”. Assume $I_r(\Sigma_{r-1}G)R \subseteq P(q(V''), \gamma_{V''})$. Let $\wp_r := v_{p_1, q_1} \cdots v_{p_{r+1}, q_{r+1}}$ be an r -path in $\Sigma_{r-1}G$. Then $X_{p_1} \cdots X_{p_{r+1}} \in \llbracket I_r(\Sigma_{r-1}G)R \rrbracket \subseteq \llbracket P(q(V''), \gamma_{V''}) \rrbracket$. So

$$X_{i_0}^{\gamma_{V''}(v_{i_0})} \mid X_{p_1} \cdots X_{p_{r+1}} \text{ for some } v_{i_0} \in q(V'').$$

Hence $v_{i_0} = v_{p_l}$ for some $l \in \{1, \dots, r+1\}$ and

$$\gamma_{V''}(v_{i_0}) \leq (\# \text{ of times } i_0 \text{ occurs in the list } p_1, \dots, p_{r+1}).$$

So $v_{p_l} = v_{i_0} \in q(V'')$. Hence $j_0 := \min\{t \mid v_{i_0, t} \in V''\}$ is well-defined. Note that $j_0 \in \{0, \dots, r-1\}$, $v_{i_0, j_0} \in V''$ and

$$1 + j_0 = \gamma_{V''}(v_{i_0}) \leq (\# \text{ of times } i_0 \text{ occurs in the list } p_1, \dots, p_{r+1}). \quad (3.63.1)$$

Since \wp_r is an r -path in $\Sigma_{r-1}G$, \wp_r is of the following form.

$$\begin{array}{ccc} v_{p_1, q_1} & & v_{p_{r+1}, q_{r+1}} \\ | & & | \\ \vdots & & \vdots \\ | & & | \\ v_{p_1, 1} & & v_{p_{r+1}, 1} \\ | & & | \\ v_{p_1+q_1, 0} = v_{p_1, 0} & \cdots & v_{p_{r+1}, 0} = v_{p_1+r-q_{r+1}, 0} \end{array}$$

where q_1 or q_{r+1} may be 0. Let $M_0 := \max_{1 \leq k \leq r+1} \{q_k \mid i_0 = p_k\}$. Then

$$1 + j_0 \leq (\# \text{ of times } i_0 \text{ occurs in the list } p_1, \dots, p_{r+1}) = 1 + M_0, \text{ i.e., } j_0 \leq M_0,$$

and there must exist a sub-path of \wp_r of the form

$$v_{i_0, 0} \text{ --- } v_{i_0, 1} \text{ --- } \cdots \text{ --- } v_{i_0, M_0}.$$

Since $0 \leq j_0 \leq M_0$, there exists a vertex in this path of the form $v_{i_0, j_0} = v_{p_k, q_k}$ for some k in $\{1, \dots, r+1\}$. So $v_{p_k, q_k} = v_{i_0, j_0} \in V''$. Thus, V'' is an r -path vertex cover of $\Sigma_{r-1}G$.

“ \Leftarrow ”. Assume V'' is an r -path vertex cover of $\Sigma_{r-1}G$. We need to show every monomial generator of $I_r(\Sigma_{r-1}G)R$ is in $P(q(V''), \gamma_{V''})$. Let $\underline{X}^b := X_{i_1} \cdots X_{i_{r+1}}$ be such a generator corresponding to an r -path $v_{i_1, j_1} \cdots v_{i_{r+1}, j_{r+1}}$ in $\Sigma_{r-1}G$. We need to show $\underline{X}^b \in P(q(V''), \gamma_{V''})$. Note that $X_{i_1, j_1} \cdots X_{i_{r+1}, j_{r+1}}$ is of the following form.

$$\begin{array}{ccc}
X_{i_1, j_1} & & X_{i_{r+1}, j_{r+1}} \\
| & & | \\
\vdots & & \vdots \\
| & & | \\
X_{i_1, 1} & & X_{i_{r+1}, 1} \\
| & & | \\
X_{i_1+j_1, 0} = X_{i_1, 0} & \text{---} \cdots \text{---} & X_{i_{r+1}, 0} = X_{i_1+r-j_{r+1}, 0}
\end{array}$$

where j_1 or j_{r+1} may be 0. So

$$j_k + 1 \leq (\# \text{ of times } i_k \text{ occurs in the list } i_1, \dots, i_{r+1}) = b_{i_k}, \forall k = 1, \dots, r+1.$$

Since $v_{i_1, j_1} \cdots v_{i_{r+1}, j_{r+1}}$ is an r -path in $\Sigma_{r-1}G$ and V'' is an r -path vertex cover of $\Sigma_{r-1}G$, we have $v_{i_l, j_l} \in V''$ for some $l \in \{1, \dots, r+1\}$. Since $\underline{X}^b = X_{i_1} \cdots X_{i_{r+1}}$,

$$\gamma_{V''}(v_{i_l}) = 1 + \min\{j \mid v_{i_l, j} \in V''\} \leq 1 + j_l \leq (\# \text{ of times } i_l \text{ occurs in the list } i_1, \dots, i_{r+1}) = b_{i_l}.$$

So $X_{i_l}^{\gamma_{V''}(v_{i_l})} \mid \underline{X}^b$. Hence $\underline{X}^b \in P(q(V''), \gamma_{V''})$. \square

The next result gives our first decomposition needed for computing $\text{type}(R'/I_r(\Sigma_r G))$.

Theorem 3.64. *One has*

$$I_r(\Sigma_{r-1}G)R = \bigcap_{V'' \text{ } r\text{-path v. cover of } \Sigma_{r-1}G} P(q(V''), \gamma_{V''}),$$

and

$$I_r(\Sigma_r G)R = \bigcap_{V'' \text{ } r\text{-path v. cover of } \Sigma_{r-1}G} P(q(V''), \gamma_{V''}) + \mathfrak{X}^{[r+1]}.$$

Proof. Since $I_r(\Sigma_r G)R = I_r(\Sigma_{r-1}G)R + \mathfrak{X}^{[r+1]}$ by Fact 3.54 and the power of each variable in each

generator of $I_r(\Sigma_{r-1}G)R$ is $\leq r$, by [8, Theorem 7.5.3], it is enough to show that

$$I_r(\Sigma_{r-1}G)R = \bigcap_{V'' \text{ } r\text{-path v. cover of } \Sigma_{r-1}G} P(q(V''), \gamma_{V''}).$$

By [8, Theorem 7.5.1], the monomial ideal $I_r(\Sigma_{r-1}G)R$ can be written as a finite intersection of m -irreducible ideals, i.e., ideals of the form $P(q(V'') := \{v_{i_1}, \dots, v_{i_t}\}, \gamma_{V''})$ with $V'' \subseteq V(\Sigma_{r-1}G)$ such that $\gamma_{V''}(v_{i_j}) = 1 + \min\{k \mid v_{i_j, k} \in V''\}$ for $j = 1, \dots, t$. Then by Theorem 3.63,

$$\begin{aligned} I_r(\Sigma_{r-1}G)R &\subseteq \bigcap_{V'' \text{ } r\text{-path v. cover of } \Sigma_{r-1}G} P(q(V''), \gamma_{V''}) \\ &\subseteq \bigcap_{V'' \text{ } r\text{-path v. cover of } \Sigma_{r-1}G \text{ in the decomp. of } I_r(\Sigma_{r-1}G)R} P(q(V''), \gamma_{V''}) \\ &= I_r(\Sigma_{r-1}G)R. \end{aligned}$$

So

$$I_r(\Sigma_{r-1}G)R = \bigcap_{V'' \text{ } r\text{-path v. cover of } \Sigma_{r-1}G} P(q(V''), \gamma_{V''}). \quad \square$$

The next result is key for our second decomposition result, Corollary 3.66.

Lemma 3.65. Let $V_1'', V_2'' \subseteq V(\Sigma_{r-1}G)$. If $V_1'' \subseteq V_2''$, then $P(q(V_1''), \gamma_{V_1''}) \subseteq P(q(V_2''), \gamma_{V_2''})$.

Proof. Assume $V_1'' \subseteq V_2''$. Let $X_i^{\gamma_{V_1''}(v_i)} \in P(q(V_1''), \gamma_{V_1''})$. Then $X_i^{\gamma_{V_2''}(v_i)} \in P(q(V_2''), \gamma_{V_2''})$ and $\gamma_{V_1''}(v_i) = \min\{j \mid v_{i,j} \in V_1''\} \geq \min\{j \mid v_{i,j} \in V_2''\} = \gamma_{V_2''}(v_i)$. So $X_i^{\gamma_{V_2''}(v_i)} \mid X_i^{\gamma_{V_1''}(v_i)}$. Hence $P(q(V_1''), \gamma_{V_1''}) \subseteq P(q(V_2''), \gamma_{V_2''})$. \square

Here is our second decomposition result for computing $\text{type}(R'/I_r(\Sigma_r G))$.

Corollary 3.66. One has

$$I_r(\Sigma_{r-1}G)R = \bigcap_{V'' \text{ min. } r\text{-path v. cover of } \Sigma_{r-1}G} P(q(V''), \gamma_{V''}),$$

and

$$I_r(\Sigma_r G)R = \bigcap_{V'' \text{ min. } r\text{-path v. cover of } \Sigma_{r-1}G} P(q(V''), \gamma_{V''}) + \mathfrak{X}^{[r+1]}.$$

Proof. By Fact 3.54 and [8, Theorem 7.5.3], it is enough to prove that

$$I_r(\Sigma_{r-1}G)R = \bigcap_{V'' \text{ min. } r\text{-path v. cover of } \Sigma_{r-1}G} P(q(V''), \gamma_{V''}).$$

By Theorem 3.64, it is enough to show that

$$\bigcap_{V'' \text{ } r\text{-path v. cover of } \Sigma_{r-1}G} P(q(V''), \gamma_{V''}) = \bigcap_{V'' \text{ min. } r\text{-path v. cover of } \Sigma_{r-1}G} P(q(V''), \gamma_{V''}).$$

“ \subseteq ” follows because every minimal r -path vertex cover is an r -path vertex cover.

“ \supseteq ” follows from Fact 3.60 and Lemma 3.65. \square

The decomposition in Corollary 3.66 may be redundant (See Example 3.73). So we define another order from which we can produce an irredundant decomposition. Lemma 3.69 is the key for understanding how this ordering helps with irredundancy.

Definition 3.67. Given two minimal r -path vertex covers V'_1, V'_2 of $\Sigma_r G$, we write $(V'_1, \gamma_{V'_1}) \leq_{\mathcal{P}} (V'_2, \gamma_{V'_2})$ if $q(V'_1) \subseteq q(V'_2)$ and $\gamma_{V'_1}|_{q(V'_1)} \geq \gamma_{V'_2}|_{q(V'_1)}$. A minimal r -path vertex cover $(V', \gamma_{V'})$ is \mathcal{P} -minimal if there is not another r -path vertex cover $(W', \gamma_{W'})$ such that $(W', \gamma_{W'}) <_{\mathcal{P}} (V', \gamma_{V'})$.

The next two results are key for our third and final decomposition result.

Proposition 3.68. For every minimal r -path vertex cover W' of $\Sigma_r G$, there is an \mathcal{P} -minimal r -path vertex cover W''' of $\Sigma_r G$ such that $W''' \subseteq W'$.

Proof. If W' is itself an \mathcal{P} -minimal r -path vertex cover for $\Sigma_r G$, then we are done. If W' is not \mathcal{P} -minimal, then either there is a $v_i \in q(W')$ that can be removed or for some $v_i \in q(W')$, the function $\gamma_{W'}|_{q(W')}(v_i)$ can be increased. In the first case, assume v_i can be removed, then remove all vertices of the form $v_{i,j}$ from W' . Repeat the process until further removal creates at least one path without a vertex to cover it. Notice that this process terminates in finitely many steps because V is finite and $q(W') \subseteq V$. Let us denote this new r -path vertex cover as W'' . If no vertices are removed, then $W' = W''$.

In the second case, if $\gamma_{W''}|_{q(W'')}(v_i)$ can be increased, then it can be done by increasing the second index of vertices of the form $v_{i,j}$ in W'' . We increase $\gamma_{W''}|_{q(W'')}(v_i)$ for each $v_i \in q(W'')$ such that any further increase would cause the set not to be an r -path vertex cover. This process also terminates in finitely many steps because $\gamma_{W''}|_{q(W'')}(v_i) \leq r + 1$ for each $v_i \in q(W'')$. Denote

the new set W''' . Since no vertices can be removed from $\gamma_{W'''}|_{q(W''')}$ and $\gamma_{W'''}|_{q(W''')}(v_i)$ for each $v_i \in q(W''')$ cannot be increased, W''' is an ρ -minimal r -path vertex cover for $\Sigma_r G$. \square

Lemma 3.69. Let V'_1, V'_2 be two minimal r -path vertex covers of $\Sigma_{r-1} G$. Then $(V'_1, \gamma_{V'_1}) \leq_\rho (V'_2, \gamma_{V'_2})$ if and only if $P(q(V'_1), \gamma_{V'_1}) \subseteq P(q(V'_2), \gamma_{V'_2})$.

Proof. $(V'_1, \gamma_{V'_1}) \leq_\rho (V'_2, \gamma_{V'_2})$ if and only if $q(V'_1) \subseteq q(V'_2)$ and $\gamma_{V'_1}|_{q(V'_1)} \geq \gamma_{V'_2}|_{q(V'_1)}$ if and only if $P(q(V'_1), \gamma_{V'_1}) \subseteq P(q(V'_2), \gamma_{V'_2})$. \square

Next, we present our third and final decomposition result which will yield the type computation in Theorem 3.71.

Theorem 3.70. *One has an irredundant parametric decomposition*

$$I_r(\Sigma_r G)R = \bigcap_{V'' \text{ } \rho\text{-min. } r\text{-path v. cover of } \Sigma_{r-1} G} P(q(V''), \gamma_{V''}) + \mathfrak{X}^{[r+1]}.$$

Proof. By Fact 3.54 and [8, Theorem 7.5.3], to verify this decomposition, it is enough to show that we have an irredundant decomposition

$$I_r(\Sigma_{r-1} G)R = \bigcap_{V'' \text{ } \rho\text{-min. } r\text{-path v. cover of } \Sigma_{r-1} G} P(q(V''), \gamma_{V''}).$$

By Corollary 3.66, it is enough to show that

$$\bigcap_{V'' \text{ min. } r\text{-path v. cover of } \Sigma_{r-1} G} P(q(V''), \gamma_{V''}) = \bigcap_{V'' \text{ } \rho\text{-min. } r\text{-path v. cover of } \Sigma_{r-1} G} P(q(V''), \gamma_{V''}).$$

“ \subseteq ” follows as every ρ -minimal r -path vertex cover is a minimal r -path vertex cover.

“ \supseteq ” follows from Proposition 3.68 and Lemma 3.69.

Finally, the intersection is irredundant by Lemma 3.69. \square

The next theorem is the third main result of this thesis. It is Formula (***) from the abstract.

Theorem 3.71.

$$\text{type}\left(\frac{R'}{I_r(\Sigma_r G)}\right) = \# \text{ } \rho\text{-minimal } r\text{-path vertex covers of } \Sigma_{r-1} G.$$

Proof. We compute

$$\begin{aligned}
\text{type}\left(\frac{R'}{I_r(\Sigma_r G)}\right) &= \text{type}\left(\frac{R'}{I_r(\Sigma_r G) + (X_i - X_{i,k} \mid 1 \leq i \leq d, 1 \leq k \leq r)R'}\right) \\
&= \text{type}\left(\frac{R}{I_r(\Sigma_r G)R}\right) \\
&= \# \text{ ideals in the irredundant parametric decomposition of } I_r(\Sigma_r G)R \\
&= \# \mathcal{P}\text{-minimal } r\text{-path vertex covers of } \Sigma_{r-1}G,
\end{aligned}$$

where the first equality is from Facts 2.93(a), 3.58(a) and 3.54, the second equality is from Fact 3.54, the third equality is from Fact 2.93(b) since $\dim\left(\frac{R}{I_r(\Sigma_r G)R}\right) = 0$, and the last equality is from Fact 3.70. \square

Remark. Because of Fact 3.58, we can use Theorem 3.71 to compute $\text{type}(R/I_r(G))$ for all trees G such that $I_r(G)$ is Cohen-Macaulay.

Example 3.72. Consider the following graph $\Sigma_2 P_2$ as in Example 3.46.

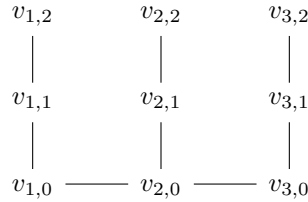

We depict the minimal 2-path vertex covers of $\Sigma_1 P_2 = \Sigma P_2$ in the following sketches.

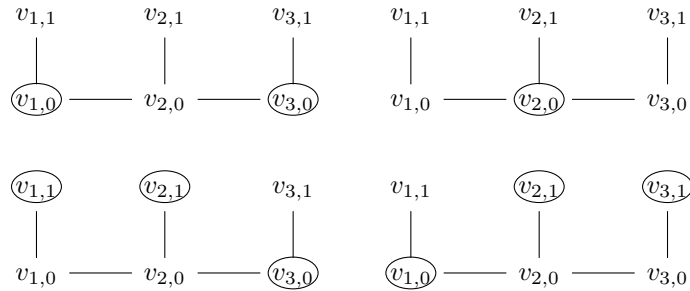

It is straightforward to show that these are all \mathcal{P} -minimal, i.e., the \mathcal{P} -minimal 2-path vertex covers

of ΣP_2 are the following.

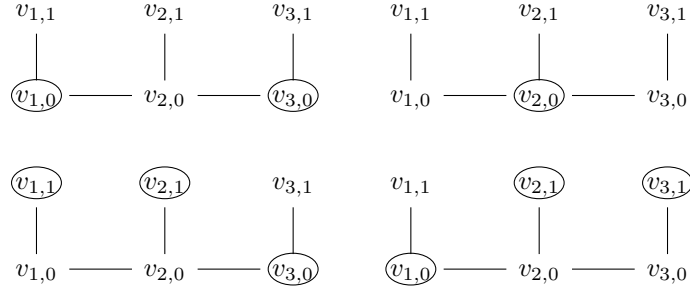

So by Theorem 3.71,

$$\text{type}(R'/I_2(\Sigma_2 P_2)) = 4.$$

We observe that the smallest number of vertices for one of the 2-path vertex covers of $\Sigma_2 P_2$ is 3. Then by Facts 3.30 and 2.69, $\dim(R'/I_2(\Sigma_2 P_2)) = 9 - 3 = 6$. Since $R'/I_2(\Sigma_2 P_2)$ is Cohen-Macaulay by Fact 3.58(a), $\text{depth}(R'/I_2(\Sigma_2 P_2)) = \dim(R'/I_2(\Sigma_2 P_2)) = 6$. Hence

$$\text{Ext}_{R'}^6(A, R'/I_2(\Sigma_2 P_2)) \cong A^4.$$

Example 3.73. The 3-path suspension $\Sigma_3 P_2$ of the path $G = P_2 = (v_1 \text{ --- } v_2 \text{ --- } v_3)$ is

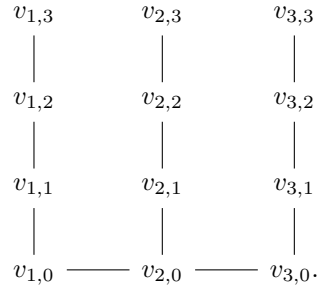

We depict the minimal 3-path vertex covers of $\Sigma_2 P_2$ in the following sketches.

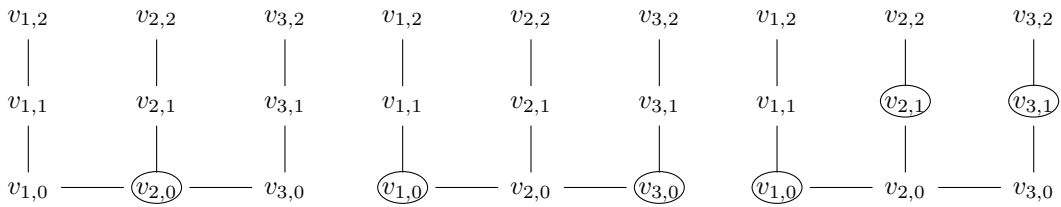

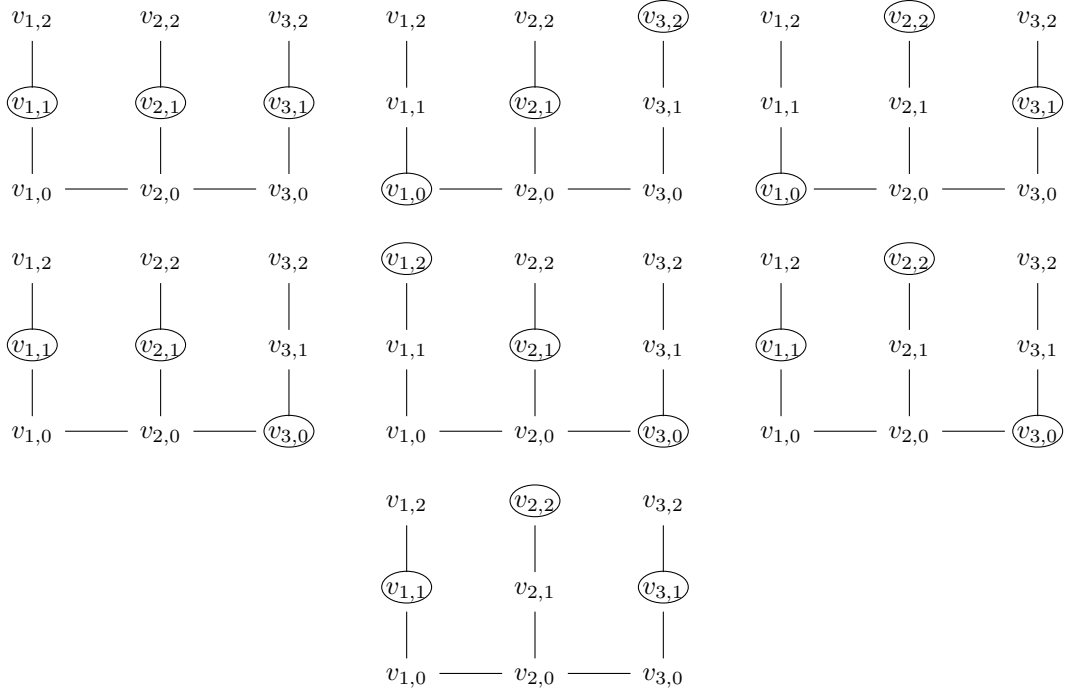

So by Theorem 3.66, we have a parametric decomposition

$$\begin{aligned}
 I_3(\Sigma_3 P_2)R &= (X_2)R \cap (X_1, X_3)R \cap (X_1, X_2^2, X_3^2)R \cap (X_1^2, X_2^2, X_3^2)R \cap (X_1, X_2^2, X_3^3)R \\
 &\quad \cap (X_1, X_2^3, X_3^2)R \cap (X_1^2, X_2^2, X_3)R \cap (X_1^3, X_2^2, X_3)R \cap (X_1^2, X_2^3, X_3)R \\
 &\quad \cap (X_1^2, X_2^3, X_3^2)R + \mathfrak{X}^3,
 \end{aligned}$$

which is an redundant decomposition since e.g., the last ideal $(X_1^2, X_2^3, X_3^2)R$ is contained in the second to last ideal $(X_1^2, X_2^3, X_3)R$. Note the \mathcal{P} -minimal 3-path vertex covers of $\Sigma_2 P_2$ are the following.

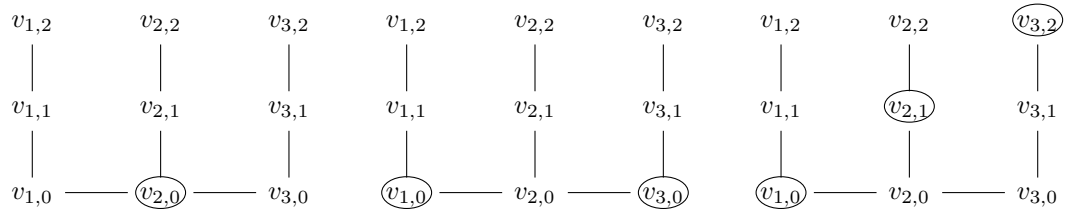

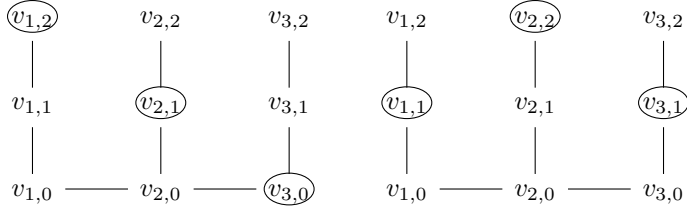

So by Theorem 3.70 and we have an irredundant parametric decomposition

$$I_3(\Sigma_3 P_2)R = (X_2)R \cap (X_1, X_3)R \cap (X_1, X_2^2, X_3^3)R \cap (X_1^3, X_2^2, X_3)R \cap (X_1^2, X_2^3, X_3^2)R + \mathfrak{x}^3,$$

and by Theorem 3.71, we have

$$\text{type}(R'/I_3(\Sigma_3 P_2)) = 5.$$

We observe that the smallest number of vertices for one of the 3-path vertex covers of $\Sigma_3 P_2$ is 3. Then by Facts 3.30 and 2.69, $\dim(R'/I_3(\Sigma_3 P_2)) = 12 - 3 = 9$. Since $R'/I_3(\Sigma_3 P_2)$ is Cohen-Macaulay by Fact 3.58(a), $\text{depth}(R'/I_3(\Sigma_3 P_2)) = \dim(R'/I_3(\Sigma_3 P_2)) = 9$ by Fact 3.16. Hence

$$\text{Ext}_{R'}^9(A, R'/I_3(\Sigma_3 P_2)) \cong A^5.$$

Bibliography

- [1] M. F. Atiyah and I. G. Macdonald. *Introduction to commutative algebra*. Addison-Wesley Publishing Co., Reading, Mass.-London-Don Mills, Ont., 1969.
- [2] Winfried Bruns and Jürgen Herzog. *Cohen-Macaulay rings revised edition*, volume 39 of *Cambridge Studies in Advanced Mathematics*. Cambridge University Press, Cambridge, 1993.
- [3] Reinhard Diestel. *Graph theory*, volume 173 of *Graduate Texts in Mathematics*. Springer, Berlin, fifth edition, 2018. Paperback edition of [MR3644391].
- [4] David S. Dummit and Richard M. Foote. *Abstract algebra*. John Wiley & Sons, Inc., Hoboken, NJ, third edition, 2004.
- [5] Ralf Fröberg. A study of graded extremal rings and of monomial rings. *Math. Scand.*, 51(1):22–34, 1982.
- [6] Jürgen Herzog and Takayuki Hibi. *Monomial ideals*, volume 260 of *Graduate Texts in Mathematics*. Springer-Verlag London, Ltd., London, 2011.
- [7] Bethany Kubik and Sean Sather-Wagstaff. Path ideals of weighted graphs. *J. Pure Appl. Algebra*, 219(9):3889–3912, 2015.
- [8] W. Frank Moore, Mark Rogers, and Sean Sather-Wagstaff. *Monomial ideals and their decompositions*. Universitext. Springer, Cham, 2018.
- [9] Chelsey Paulsen and Sean Sather-Wagstaff. Edge ideals of weighted graphs. *J. Algebra Appl.*, 12(5):1250223, 24, 2013.
- [10] Sean Sather-Wagstaff. Homological algebra notes. *Unpublished lecture notes*. Available at <http://ssather.people.clemson.edu/notes.html>, 2009.
- [11] Rafael H. Villarreal. Cohen-Macaulay graphs. *Manuscripta Math.*, 66(3):277–293, 1990.