

5-2012

On factoring Hecke eigenforms, nearly holomorphic modular forms, and applications to L-values

Jeff Beyerl

Clemson University, JBAYERL@Clemson.edu

Follow this and additional works at: https://tigerprints.clemson.edu/all_dissertations



Part of the [Applied Mathematics Commons](#)

Recommended Citation

Beyerl, Jeff, "On factoring Hecke eigenforms, nearly holomorphic modular forms, and applications to L-values" (2012). *All Dissertations*. 891.

https://tigerprints.clemson.edu/all_dissertations/891

This Dissertation is brought to you for free and open access by the Dissertations at TigerPrints. It has been accepted for inclusion in All Dissertations by an authorized administrator of TigerPrints. For more information, please contact kokeefe@clemson.edu.

ON FACTORING HECKE EIGENFORMS, NEARLY HOLOMORPHIC
MODULAR FORMS, AND APPLICATIONS TO L -VALUES

A Dissertation
Presented to
the Graduate School of
Clemson University

In Partial Fulfillment
of the Requirements for the Degree
Doctor of Philosophy
Number Theory

by
Jeffrey Beyerl
May 2012

Accepted by:
Dr. Kevin James, Dr. Hui Xue, Committee Chairs
Dr. James Brown
Dr. Neil Calkin

Abstract

This thesis is a presentation of some of my research activities while at Clemson University. In particular this includes joint work on the factorization of eigenforms and their relationship to Rankin-Selberg L -values, and nearly holomorphic eigenforms. The main tools used on the factorization of eigenforms are linear algebra, the j function, and the Rankin-Selberg Method. The main tool used on nearly holomorphic modular forms is the Rankin-Cohen bracket operator.

The main results are Theorems 2.3.1, 3.1.1, and 3.5.4.

Theorem 2.3.1 identifies the pairs of nearly holomorphic eigenforms which multiply to an eigenform.

Theorem 3.1.1 identifies, under some technical conditions, which eigenforms can divide other eigenforms.

Theorem 3.5.4 states a condition under which a certain set of vectors of L values are necessarily independent.

Acknowledgments

While the work for this thesis has taken a significant amount of time and work I would like to thank those people that have helped me along the way. Most notably are my advisors Kevin James and Hui Xue whom have given me ample guidance over the past four years. I would also like to thank Catherine Trentacoste whom I worked closely with on the material presented in the second chapter.

Table of Contents

Title Page	i
Abstract	ii
Acknowledgments	iii
1 Introduction	1
1.1 The Upper Half Plane	1
1.2 Modular Forms	3
1.3 Zeros of Modular Forms	7
1.4 L-functions	9
1.5 Hecke Operators	12
1.6 Petersson Inner Product	14
1.7 The Rankin-Selberg Convolution	14
1.8 Maeda's Conjecture	15
1.9 Eisenstein Series Conjecture	16
1.10 Galois Actions	16
1.11 The Rankin-Cohen Bracket Operator	17
1.12 The Nearly Holomorphic Setting	18
1.13 Previous Results	20
2 Results on Nearly Holomorphic Modular Forms	21
2.1 Introduction	21
2.2 Nearly Holomorphic Modular Forms	22
2.3 Main Result	28
3 Divisibility of an Eigenform by another Eigenform	31
3.1 Introduction and Statement of Main Results	31
3.2 Proof of Theorem 3.1.3	33
3.3 Proof of Theorem 3.1.4	35
3.4 Proof of Theorem 3.1.5	36
3.5 Relationship to L -values	38
3.6 Conclusions and Maeda's Conjecture	40
4 Computations	43
4.1 Computing Examples	43
4.2 Computing $\varphi_k(x)$	43
4.3 Basic Idea	44
5 Future Directions	46
5.1 The Rankin-Cohen Bracket Operator	46

5.2	Nearly Holomorphic Modular Forms	47
5.3	Properties of $\varphi_k(x)$	47
5.4	Add level	48
5.5	The general question	48
5.6	More computations	49
	Bibliography	49
	Index	52

Chapter 1

Introduction

This chapter provides necessary background material for the main results of the thesis. The required definitions and theorems are given, along with an occasional sketch of a proof. For more information and a deeper study, readers can see an introductory text on modular forms such as the text by Diamond and Shurman [8], Koblitz [23], Miyake [27], or Shimura [33].

To summarize, modular forms of level one form a graded ring. A very special type of modular form is called an eigenform. A natural question to ask, then, is if the product of two eigenforms is again an eigenform. This question has been answered by Ghatte [16] and Duke [9]. Part of my thesis focuses on a similar problem: when is the product of an eigenform with any modular form again an eigenform. The other part of this thesis answers the original question for nearly holomorphic modular forms.

1.1 The Upper Half Plane

The first fundamental structure in the study of modular forms is the upper half plane, $\mathbb{H} := \{z \in \mathbb{C} \mid \text{Im}(z) > 0\}$, shown in Figure 1.1.1. Of particular interest will be the fundamental domain, \mathbb{H} , when acted upon by $SL_2(\mathbb{Z})$; this is the standard action and is defined below. In particular $SL_2(\mathbb{Z})$ acts from the left on \mathbb{H} , with resulting fundamental domain given in Figure 1.1.2. We write the quotient as $SL_2(\mathbb{Z}) \backslash \mathbb{H}$. In general there is a similar construction for any congruence subgroup Γ of $SL_2(\mathbb{Z})$ to construct $\Gamma \backslash \mathbb{H}$. We will not say more on this as we are working in full level (meaning $\Gamma = SL_2(\mathbb{Z})$). However, do note that while some of these results should generalize to

Figure 1.1.1: The Upper Half Plane

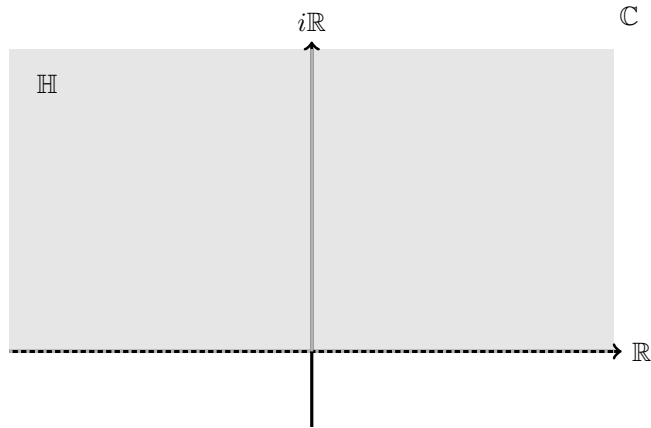
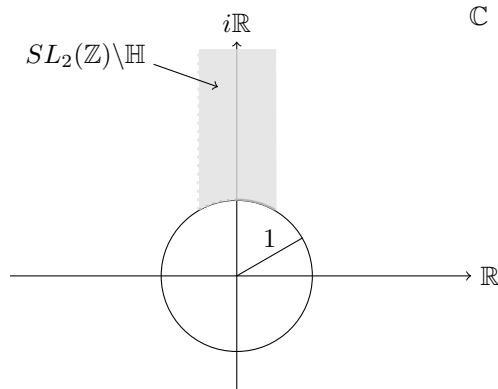

Figure 1.1.2: The Fundamental Domain



higher levels, it is not clear how many of them do. See Section 1.8 for a discussion on why it is not obvious how to generalize these to higher levels.

The aforementioned action is obtained via the standard action:

$$\begin{bmatrix} a & b \\ c & d \end{bmatrix} z = \frac{az + b}{cz + d}$$

which is often called a fractional linear transformation or Möbius transformation. More on this action can be found in a text on complex analysis such as Conway's [6]. Under this action we obtain the fundamental domain as a complete set of coset representatives, shown in Figure 1.1.2.

1.2 Modular Forms

Periodic functions have Fourier series expansions. In particular say $f(z+1) = f(z)$, then we may write

$$f(z) = \sum_{n=-\infty}^{\infty} a_n(f)q^n$$

where $q = e^{2\pi iz}$. This is often called the q -expansion of f . Modular forms in particular, defined below, have such an expansion due to the transformation law.

Definition 1.2.1. *A modular form of weight k for $SL_2(\mathbb{Z})$ is a holomorphic function on \mathbb{H} and at ∞ (meaning its Fourier series expansion has only terms with nonnegative exponent on q) satisfying the following transformation law.*

$$f\left(\frac{az+b}{cz+d}\right) = (cz+d)^k f(z) \text{ for all } \begin{bmatrix} a & b \\ c & d \end{bmatrix} \in SL_2(\mathbb{Z}).$$

A modular function satisfies the same transformation law, but need only be meromorphic.

A special type of modular form are called cuspidal.

Definition 1.2.2. *A modular form f is said to be a cuspidal modular form if its Fourier expansion has no constant term: $a_0 = 0$. This could also be thought of as f vanishes at ∞ .*

As there are no modular forms of odd weight or weight less than 4 for $\Gamma = SL_2(\mathbb{Z})$, modular forms in this thesis will always be of even weight at least 4.

We will denote the space of cusp forms of weight k by S_k , and the space of all modular forms of weight k by M_k . These are both \mathbb{C} -vector spaces.

The growth rate of a modular form is the asymptotic growth rate of the Fourier coefficient $a_n(f)$ as n goes to infinity. To illustrate growth rates we use big-oh, big-omega, and big-theta notation. In particular $f(n)$ grows at rate $O(g(n))$ if there is a constant c such that beyond some point, $f(n) \leq cg(n)$. Similarly $f(n)$ grows at rate $\Omega(f(n))$ if there is a constant c such that beyond some point, $f(n) \geq cg(n)$, and $f(n)$ grows at rate $\Theta(g(n))$ if $f(n)$ grows at $\Omega(g(n))$ and $O(g(n))$.

For modular forms of weight k , the growth rate is $O(n^{k-1})$, and for some forms (such as Eisenstein series) this is sharp: that is, $\Theta(n^{k-1})$. Cusp forms grow much slower, $O(n^{\frac{k-1}{2}+\varepsilon})$ for all $\varepsilon > 0$. This is a nontrivial result; for more information see any introductory text on modular forms,

such as page 122 of [23].

We now consider the simplest examples of modular forms.

Example 1.2.3. *The weight k Eisenstein series is a modular form, given by*

$$E_k(z) = 1 - \frac{2k}{B_k} \sum_{n=1}^{\infty} \sigma_{k-1}(n)q^n$$

where $\sigma_{k-1}(n) := \sum_{m|n} m^{k-1}$ is an extension of the sum of divisors function and B_k is the k^{th} Bernoulli number. Because we use Eisenstein series throughout this work we give the first few terms in the Fourier expansion of the small weight Eisenstein series:

$$E_4 = 1 + 240q + 2160q^2 + \Omega(q^3)$$

$$E_6 = 1 - 504q - 16632q^2 + \Omega(q^3)$$

$$E_8 = 1 + 480q + 41920q^2 + \Omega(q^3)$$

$$E_{10} = 1 - 264q + 135432q^2 + \Omega(q^3)$$

$$E_{12} = 1 + \frac{65520}{691}q + \frac{134250480}{691}q^2 + \Omega(q^3) \in \frac{1}{691}\mathbb{Z}[[q]]$$

$$E_{14} = 1 - 24q - 196632q^2 + \Omega(q^3)$$

The simplest example of a cuspidal modular form is the Delta function, given as below.

Example 1.2.4. *A weight 12 cusp form is $\Delta(z)$ given by*

$$\Delta(z) = q \prod_{n=1}^{\infty} (1 - q^n)^{24} = \sum_{n=1}^{\infty} \tau(n)q^n = q - 24q^2 + 252q^3 + \Omega(q^4) \in \mathbb{Z}[[q]].$$

When the space S_k of cusp forms of weight k is of dimension one, we denote the unique modular form with first coefficient equal to 1 as $\Delta_k = E_4^a E_6^b \Delta$ where $k = 12 + 4a + 6b$. Due to their importance, Eisenstein series E_k and the Delta function Δ will reappear throughout the sequel. In particular as will be seen below every noncuspidal modular form has an ‘‘Eisenstein series part’’ and every cuspidal modular form has a factor of Δ .

While not truly a modular form because it is only meromorphic at ∞ , another important example is the j -function (also called the j -invariant) which is a modular function of weight zero for $SL_2(\mathbb{Z})$. This function has numerous applications from elliptic curves to group theory.

Figure 1.2.6: Dimension of M_k and S_k

k	$\dim(M_k)$	$\dim(S_k)$
4	1	0
6	1	0
8	1	0
10	1	0
12	2	1
14	1	0
16	2	1
18	2	1
20	2	1
22	2	1
24	3	2
26	2	1
28	3	2
30	3	2

Definition 1.2.5. *The j -function is the weight zero modular function defined by:*

$$j = \frac{E_4^3}{E_4^3 - E_6^2}.$$

Our use of the j -function is in its role in the Eisenstein polynomials, defined in the following section on page 9.

The dimension of the space of modular forms of weight k is well known and quasiperiodic with period 12. In particular

$$\dim(M_k) = \begin{cases} \left[\frac{k}{12} \right], & k \not\equiv 0, 2 \pmod{12} \\ \left[\frac{k}{12} \right] + 1, & k \equiv 0 \pmod{12} \\ \left[\frac{k}{12} \right] - 1, & k \equiv 2 \pmod{12} \end{cases}$$

and for $k \geq 4$, $\dim(M_{k+12}) = \dim(M_k) + 1$. The first couple dimensions are tabulated in Figure 1.2.6. The dimension of M_k and S_k are always one different: $\dim(M_k) = \dim(S_k) + 1$. This is because,

$$M_k = \mathcal{E}_k \oplus S_k,$$

where $\mathcal{E}_k = \langle E_k \rangle_{\mathbb{C}}$ is always 1 dimensional.

When using the dimension in a computer program, it is more convenient to use a non-piecewise formula for the dimension, in particular:

$$\dim(M_k) = 1 + \left\lfloor \frac{k-3}{12} \right\rfloor + 1 - \left\lfloor \frac{k \% 12}{12} \right\rfloor$$

where $a \% b$ denotes a reduced modulo b . The following remark illuminates a curious tidbit of information.

Remark 1.2.7. M_k has finite dimension, but yet every $f \in M_k$ has an infinite Fourier series expansion.

In particular almost all of the terms in the Fourier series expansion are redundant, and knowing the first $\dim(M_k)$ coefficients of the Fourier expansion of a modular form is enough to know the modular form (In general knowing $\dim(M_k)$ coefficients is not always sufficient unless if they are the indeed the first $\dim(M_k)$ coefficients).

There is a basis of M_k which makes this clear:

$$\{\Delta^a E_b \mid 12a + b = k, "E_0 = E_2 = 1"\}.$$

The above is the so called diagonal basis, because each factor of Δ forces precisely one Fourier coefficient to be zero: $\Delta = q + \Omega(q^2), \Delta^2 = q^2 + \Omega(q^3), \dots, \Delta^a = q^a + \Omega(q^{a+1})$.

Another useful spanning set of M_k involves only E_4, E_6 and Δ :

$$\{\Delta^a E_4^b E_6^c \mid 12a + 4b + 6c = k\}.$$

Sometimes this set is theoretically useful. However it is computationally less useful because it is in general not a basis and involves much larger coefficients (Recall that the coefficients of Δ grow considerably slower than those of Eisenstein series). Calculating the coefficients of Δ is nontrivial computationally, but must be done in both cases. Precomputing coefficients of the Eisenstein is trivial compared to when one starts to perform arithmetic upon them.

Note that this thesis deals with factoring modular forms, and so we need to know something about how modular forms of different weights interact.

Fact 1.2.8. Let $f \in M_k, g \in M_l$, then $fg \in M_{k+l}$.

From this we see that the collection of all modular forms a graded complex algebra where the grading comes from the weight. By graded \mathbb{C} -algebra we mean that the collection can be decomposed as $\bigoplus_{k=4}^{\infty} M_k$ satisfying the above fact, where each M_k is in fact a \mathbb{C} -vector space.

1.3 Zeros of Modular Forms

In this section we give some of the results on the zeros of modular forms, in particular that of Eisenstein Series. While none of the proofs directly use zeros, they are useful in providing insight to some of our results.

The number of zeros of a weight k modular form f is given by the valence formula:

$$v_{\infty}(f) + \frac{1}{2}v_i(f) + \frac{1}{3}v_{\rho}(f) + \sum_{\substack{P \in \Gamma \backslash H \\ P \neq i, \rho}} v_P(f) = \frac{k}{12}$$

where $v_P(f)$ is the order of vanishing of f at P ; i and $\rho = e^{i\pi/3}$ are the second and third roots of -1 respectively. See the discussion in the text by Koblitz [23, p. 115] for more information.

Let E_k be an Eisenstein series. Then it is known that all of the zeros of E_k in the fundamental domain lie on the unit circle. In particular all the zeros lie between i and ρ . This is shown in [29] by counting the zeros on the arc in question and showing that there are enough to exhaust the valence formula. In fact all of the zeros other than i and ρ are simple, and equidistributed (meaning that a certain collection of arcs of angle $\frac{2\pi}{k}$ each have precisely one root). See Figures 1.3.1 and 1.3.2 for examples of where these zeros of Eisenstein series lie.

One can also compare the zeros of E_k and E_{k+12} . Any zero of E_{k+12} lies between two consecutive zeros of E_k , as is discussed in [28]. Little appears to be known about the specific relationship with other Eisenstein series.

In Chapter 3 we will use the Eisenstein polynomial $\varphi_k(x)$ related to the zeros of the weight k Eisenstein series. This polynomial appeared in [7] and [14], although we coined the term Eisenstein polynomial. We now define $\varphi_k(x)$. Let j be the j -function as defined in Definition 1.2.5. Now j maps the fundamental domain to the entire complex plane (including ∞). In particular it maps the above arc of the unit circle to the interval $[0, 1728]$ of the real line. Actually it maps according the top diagram (Figure 1.3.3). Section A along the real axis is the interval $[0, 1728]$ corresponding to section A in the fundamental domain.

Figure 1.3.1: The three zeros of E_{36}

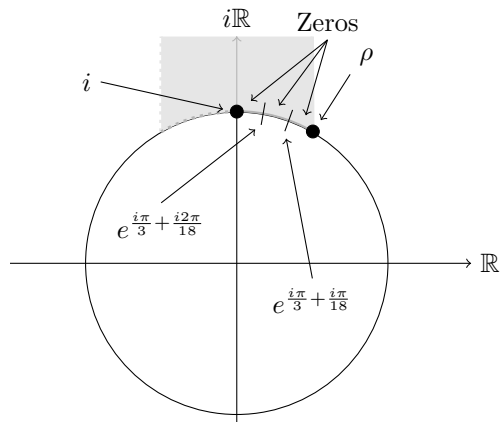

Figure 1.3.2: The five zeros of E_{46}

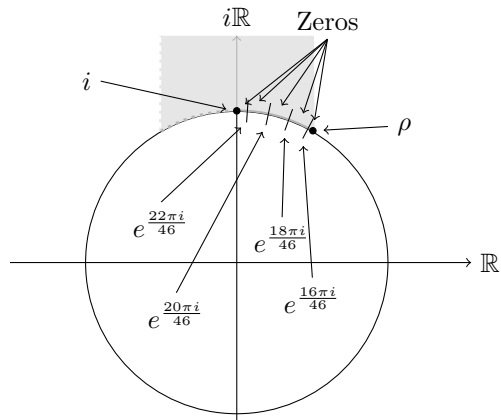
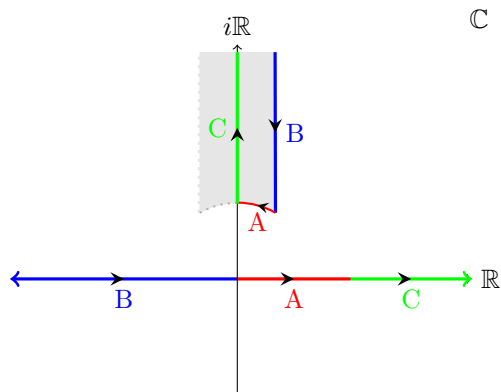

Figure 1.3.3: The set where j is real



Write $k = 12n + s$ where $s \in \{0, 4, 6, 8, 10, 14\}$. Then E_k has n zeros other than i and ρ . Label these as a_1, \dots, a_n . Then the j -zeros of E_k are $j(a_1), \dots, j(a_n)$ along with possibly 0 and 1728 corresponding to ρ and i respectively. We use these j -zeros to construct the Eisenstein polynomial.

Definition 1.3.4. *Let j, a_1, \dots, a_n be as above. Then $\varphi_k(x) := \prod(x - j(a_i))$.*

Note that $\varphi_k(x)$ is monic with rational coefficients, as shown in [15]. It is observed in the same paper that $\varphi_k(x)$ appears to be irreducible with full Galois group. They verified this for $k \leq 172$. In Chapter 4 we verify the irreducibility of $\varphi_k(x)$ up to weight 2500.

1.4 L-functions

Associated to any modular form is a corresponding L -function, constructed as follows. Let $f = \sum a_n q^n$ be a modular form, then for $Re(s) \gg 0$, the L -function associated to f is defined as

$$L(f, s) := \sum_{n=1}^{\infty} \frac{a_n}{n^s}$$

which is the Mellin transform of f . Note that a_0 does not affect the L -function. These functions exist for both cuspidal and noncuspidal modular forms. L -functions have important applications in and outside of mathematics, although my work does not touch on their applications.

Figure 1.4.1: The partial sums of $L(\Delta, 7)$

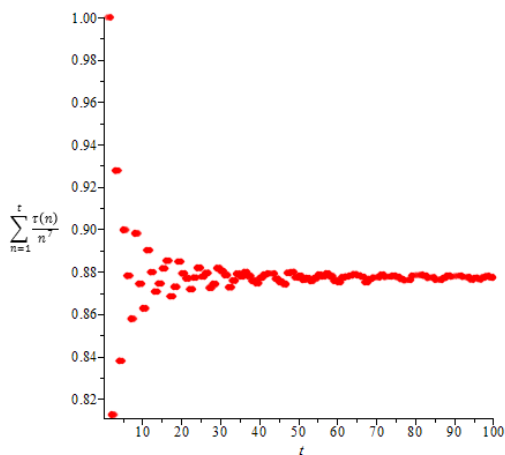

The L -function will not converge for every s . However, for s at least one more than the growth rate, the L -function always converges.

As an example, consider $L(\Delta, 7) = \sum_{n=1}^{\infty} \frac{\tau(n)}{n^7} \approx 0.877$ (Calculated algebraically using a thousand coefficients). The point $s = 7$ was chosen because that is well within the region of convergence. In particular $\tau(n)$ has growth rate $O(n^{5.5+\epsilon})$, so that $L(\Delta, s)$ converges for all s with $Re(s) > 6.5$. See [2] for more on these convergence rates.

Note that because τ takes on both positive and negative values, the partial sums are

not monotonic, as illustrated in Figure 1.4.1. One can see the approximations for other values of $L(\Delta, s)$ in Figure 1.4.3.

More generally we will use the Rankin-Selberg convolution L -function of two modular forms $f = \sum a_n q^n$ and $g = \sum b_n q^n$, for $Re(s) \gg 0$;

$$L(f \times g, s) := \sum_{n=1}^{\infty} \frac{a_n \overline{b_n}}{n^s}.$$

We will be interested in the specific case when both f and g are cuspidal eigenforms, and $s = wt(g)$. A L -value is the value of a L -function at a specified argument s . These are important values of functions in mathematics.

As an example consider $L(\Delta, E_4, 9.6) = -4/B_4 \cdot \sum_{n=1}^{\infty} \frac{\tau(n)\sigma_3(n)}{n^{9.6}} \approx 96.12$. To see an illustration of the partial sums (The convergence is not too fast as 9.6 is closer to the boundary of convergence at 9.5), see Figure 1.4.2

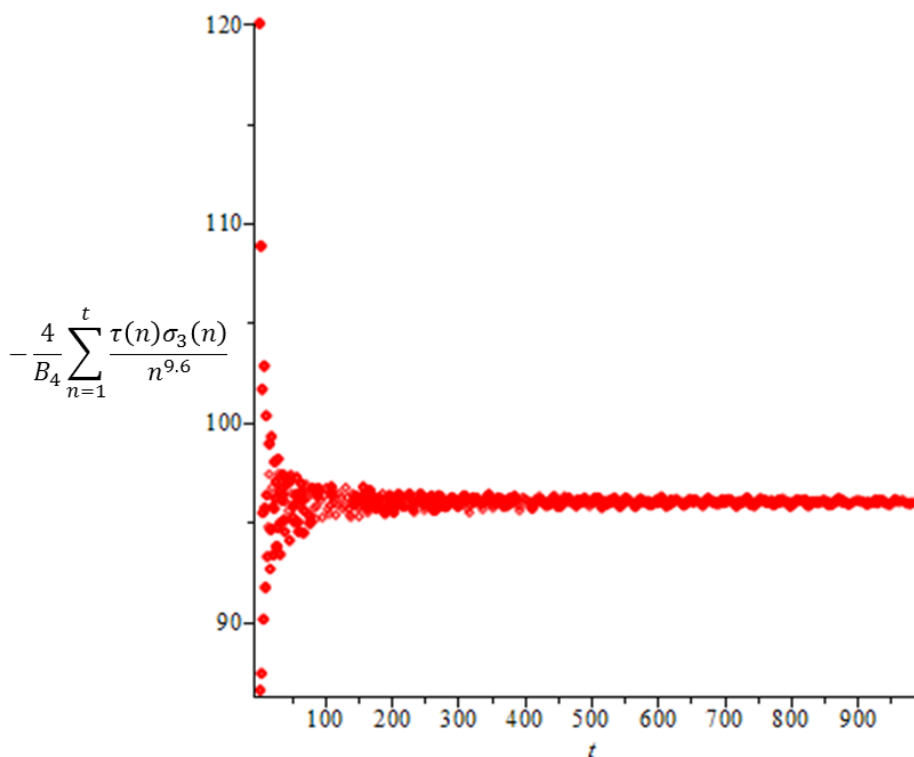
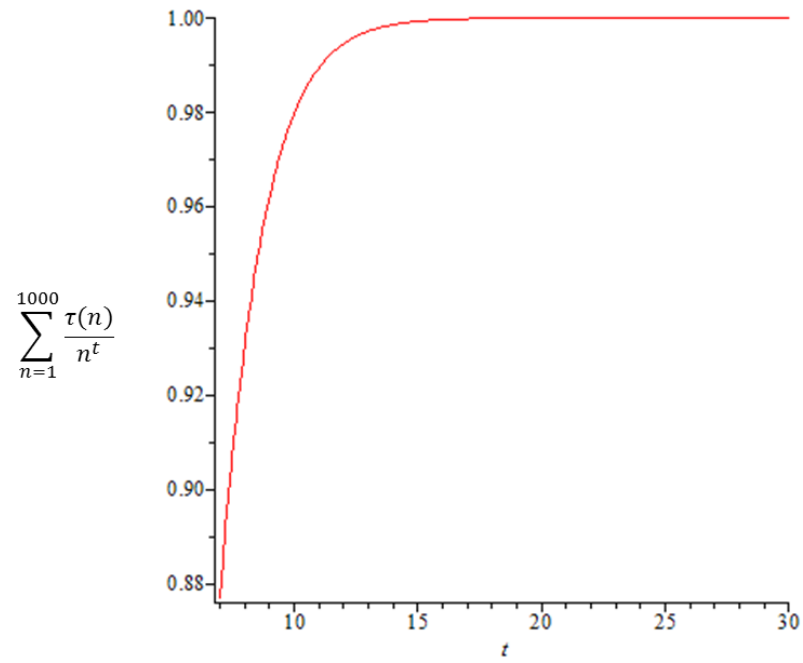

Figure 1.4.2: The partial sums of $L(\Delta, E_4, 9.6)$

Figure 1.4.3: Approximations of $L(\Delta, t)$



1.5 Hecke Operators

A Hecke Operator $T_{n,k}$ is a specific linear operator defined on M_k . Following [23] we introduce the double-coset definition of a Hecke Operator for level 1. If f is a modular form, and $n \in \mathbb{Z}_{\geq 0}$, then

$$T_n(f) := n^{k/2-1} \sum f|[\Gamma\alpha\Gamma]_k$$

where $\Gamma\alpha\Gamma$ is a double-coset. Define $f|[\Gamma\alpha\Gamma]_k := \sum f|[\alpha\gamma_j]_k$, $f|[\alpha\gamma]_k := (cz+d)^{-k} f(\gamma z)$ with the summations over all double cosets of Γ and Γ in $\Delta^n(1, \mathbb{Z}, \mathbb{Z}) = \left\{ \begin{bmatrix} a & b \\ c & d \end{bmatrix} \in \mathbb{Z}^{2 \times 2} \mid \det \begin{bmatrix} a & b \\ c & d \end{bmatrix} = n \right\}$ and all coset representatives of $\Gamma \cap \alpha^{-1}\Gamma\alpha$ in Γ respectively. For our work this definition is cumbersome, and so we will introduce several equivalent formulations of a Hecke Operator. The version we will use is a functional description:

$$(T_{n,k}(f))(z) = n^{k-1} \sum_{d|n} d^{-k} \sum_{b=0}^{d-1} f\left(\frac{nz+bd}{d^2}\right).$$

Another approach to the Hecke Operator is to define it on a basis of $SL_2(\mathbb{Z})$. In particular one could use the following matrices for prime p . Consider the matrices $U = \begin{bmatrix} 0 & 1 \\ 1 & 0 \end{bmatrix}$ and $V = \begin{bmatrix} 1 & 1 \\ 1 & 0 \end{bmatrix}$ that form a basis for $SL_2(\mathbb{Z})$. We can decompose T_p in terms of two simpler operators: U_p and V_p defined via:

$$U_p f(z) := f(pz)$$

$$V_p f(z) := \frac{1}{p} \sum_{j=0}^{p-1} f\left(\frac{z+j}{p}\right),$$

in which case we obtain $T_p = U_p + p^{k-1}V_p$.

We shall also give a formulation of T_n by how it acts on Fourier expansions. Say $f(z) = \sum a_i q^i$ and $T_n(f)(z) = \sum b_i(n) q^i$, we wish to identify the b_i . Computationally, this is how a Hecke operator may be calculated. In particular $b_i = \sum d^{k-1} a_{ni/d^2}$, the summation is over d dividing $\gcd(n, i)$. In the event that $n = p$ is prime, this boils down to $a_{pi} + p^{k-1} a_{i/p}$ for $p|i$ and merely $b_i = a_{pi}$ for $p \nmid i$.

Note that the i^{th} term in the Fourier expansion of $T_n(f)$ requires information about a_{ni} ,

the $n \times i^{\text{th}}$ term of f .

Fact 1.5.1. • $T_{n,k}$ preserves the cusp space S_k .

- $T_{n,k}$ preserves the Eisenstein space $\mathcal{E} = \langle E_k \rangle_{\mathbb{C}}$.
- $T_{n,k}T_{m,k} = T_{m,k}T_{n,k}$ for all n, m .

We can now define the functions of interest in this thesis: Hecke eigenforms.

Definition 1.5.2. A modular form $f \in M_k$ is said to be an eigenform if for all $n \in \mathbb{N}$ there are $\lambda_n \in \mathbb{C}$ so that $T_{n,k}f = \lambda_n f$. That is, f is an eigenvector for all of the T_n simultaneously. An eigenform is said to be normalized if the first nonzero coefficient is 1. For cuspidal eigenforms this will always be the q coefficient. In fact, the coefficients of normalized cuspidal eigenforms are their eigenvalues.

We have already seen some examples of eigenforms. In particular an Eisenstein series as we have defined it is always eigenform. The small weight cuspforms $\{\Delta_{12}, \dots, \Delta_{22}, \Delta_{26}\}$ are also eigenforms. All of these examples come trivially from the fact that $T_{n,k}$ is acting on a one-dimensional space. It is more interesting to see that cuspidal eigenforms not only exist for other weights, but that there is always a proper number of them. The following theorem is common in the literature, such as [23].

Theorem 1.5.3. S_k has a basis of eigenforms. Further, if $m = \dim(S_k)$, then all of the eigenvalues of $T_{n,k}$ lie in a degree m extension of \mathbb{Q} . Let f denote a normalized cuspidal eigenform. Then $a_n(f) = \lambda_n$, where λ_n is an eigenvalue of $T_{n,k}$.

The Hecke Polynomial $T_{n,k}(x)$ is the characteristic polynomial of $T_{n,k}$ on S_k . It is a polynomial of degree $\dim(S_k)$.

Definition 1.5.4. The Hecke Algebra is the algebra generated over \mathbb{Z} by all Hecke Operators $\{T_{n,k}\}_{n \in \mathbb{N}, k \in 2\mathbb{Z}_{\geq 2}}$. Furthermore $T_{p_1^{a_1} \dots p_r^{a_r}} = T_{p_1^{a_1}} \dots T_{p_r^{a_r}}$ where $T_{p^t} = T_{p^{t-1}}T_p - pT_{p^{t-2}}T_p$.

While we will not use the Hecke algebra itself; a conjecture we reference (Maeda's Conjecture) makes a strong claim regarding this algebra.

Also of note are Euler products. In particular an Euler Product is an infinite product

indexed by the primes. In the case of a normalized eigenform $f = \sum a_n q^n$, we have for $Re(s) \gg 0$

$$L(f, s) = \prod_p (1 - a_p p^{-s} + p^{k-1-2s})^{-1}.$$

1.6 Petersson Inner Product

The space of modular forms of weight k is actually an inner product space under the Petersson inner product. This is defined, for f or g cuspidal, as

$$\langle f, g \rangle := \int_{\Gamma \backslash \mathbb{H}} f(z) \overline{g(z)} y^k \frac{dx dy}{y^2}.$$

The domain of integration is over a fundamental domain $\Gamma \backslash \mathbb{H}$ and the measure used for integration is $\frac{dx dy}{y^2}$. This is a Γ -invariant measure, so that any fundamental domain may be chosen for integration.

Hecke operators interact very nicely with this inner product. In particular Hecke operators are self-adjoint with respect to the Petersson inner product, meaning that $\langle Tf, g \rangle = \langle f, Tg \rangle$.

For more information see any introductory textbook such as [23] for details.

1.7 The Rankin-Selberg Convolution

The Rankin-Selberg Convolution is a very general technique for relating inner products and L -values. Let f be a weight k cuspidal modular form, and g a cuspidal modular form of weight such that $\langle f \cdot E_s, g \rangle$ makes sense. Our specific need will be the following equation relating the Petersson inner product to an L -function:

$$\langle f \cdot E_s, g \rangle = (4\pi)^{-(s+k-1)} \Gamma(s+k-1) \sum_{n \geq 1} \frac{a_n \overline{b_n}}{n^{s+k-1}}.$$

This is proven in [13], with the key being that $y^s f(z)g(z)$ is P -invariant, where $P \subset \Gamma$ contains

matrices of the form $\begin{bmatrix} \star & \star \\ 0 & \star \end{bmatrix}$.

Note that the right hand side above is essentially an L -function. There is a constant out in

front, but the idea behind the Rankin-Selberg convolution in this case is the following:

$$\langle f, E_s g \rangle = \text{const} \cdot L(f, g).$$

One can already see how this might be applied to our situation: $E_s g$ is a product of modular forms. What if it is an eigenform? In Chapter 3 we will consider this and choose f appropriately.

1.8 Maeda's Conjecture

Maeda's Conjecture was first introduced in [19] in 1997. The conjecture makes a very strong claim regarding the structure of the Hecke algebra. The precise statement is below.

Conjecture 1.8.1 (Maeda, [19]). *The Hecke algebra over \mathbb{Q} of $S_k(SL_2(\mathbb{Z}))$ is simple (that is, a single number field) whose Galois closure over \mathbb{Q} has Galois group isomorphic to a symmetric group S_m (with $m = \dim S_k(SL_2(\mathbb{Z}))$).*

The conjecture has been verified for numerous weights. It was verified to weight 469 in the original paper. Later Farmer and James [12] show for prime weights less than 2000 that $T_{n,p}(x)$ has full Galois group. While Maeda's conjecture is actually quite strong, we need only the irreducibility implied by it. In particular, a corollary of Maeda's conjecture is that $T_{n,k}(x)$ is irreducible for every choice of n and k . This aspect of the conjecture has been verified up to weight 4096 by Ghitza ([18]). Probably this can be pushed much further by checking modulo p ; as Ghitza appears to have actually calculated every $T_n(x)$. More could be said along these lines by calculating all the different types of factorizations that appear modulo p . Some of the current work requires only irreducibility over \mathbb{Q} , while some of it requires irreducibility over slightly larger fields. In particular over the fields K referred to in the following proposition. This proposition is proved in Section 3.6.

Proposition 1.8.2. *Let $P(x) \in \mathbb{Q}[x]$ be a degree d polynomial. Let K_P be its splitting field. Assume $[K_P : \mathbb{Q}] = d!$, i.e., $\text{Gal}(K_P/\mathbb{Q}) \cong S_d$. If P factors over K , then $[K : \mathbb{Q}] \geq d$.*

In particular this tells us that if a polynomial has full Galois group, then it is irreducible over all fields of small degree.

As a final comment regarding Maeda's conjecture, the analogous statement with level $\Gamma_0(N)$ is false. In particular, when p divides the level, $T_{p,k}$ may not be diagonalizable, and thus factors

over a field of smaller degree than allowable by Maeda's conjecture. For example on $S_{12}(\Gamma_0(2))$, $T_2(x) = x^2(x^2 + 24x + 2048)$ which clearly is not irreducible.

1.9 Eisenstein Series Conjecture

This section regards a conjecture about the Eisenstein polynomials. In particular recall $\varphi_k(x) := \prod(x - j(a_i))$ as defined in Section 1.3. The conjecture below arises from computational evidence, and appeared in [7] and [14] albeit not explicitly stated.

Conjecture 1.9.1 (Cornelissen [7] and Gekeler [15]). *The Eisenstein polynomial $\varphi_k(x)$ is irreducible with full symmetric group as Galois group.*

Essentially $\varphi_k(x)$ encodes the nontrivial roots of E_k . The qualifier essentially was used because the roots of $\varphi_k(x)$ are not actually the roots of the Eisenstein series. Instead they are the roots after going through the j map. Refer back to Figure 1.3.3 for an illustration of j zeros. We will use the irreducibility of this function in Section 3.4. To verify the irreducibility of this function we calculated $\varphi_k(x)$ modulo several primes for k up through 2500. This used an equation presented in [21] which relates $\varphi_k(x)$ to j :

$$\frac{E_r}{E_4^a E_6^b \Delta^c} = \varphi_k(j(\tau)),$$

where $4a + 6b + 12c = r$, with $0 \leq a \leq 2$, $0 \leq b \leq 1$. Note that this is a nontrivial problem in particular because of the required computation of the powers of j .

Also note that one could in theory show the full conjecture by finding $\varphi_k(x)$ modulo enough primes to find enough different types of factorizations so that its Galois group must be large enough to contain them all: in particular the full symmetric group.

1.10 Galois Actions

First recall that a field is said to be Galois if the size of the automorphism group is as large as possible: that is if $|\text{aut}(\mathbb{F})| = \dim_{\mathbb{Q}}(\mathbb{F})$.

The Galois group of a polynomial is the Galois group of its splitting field, where the splitting field of a polynomial is the smallest field that contains all its roots.

Let $f = \sum a_n q^n$ be an eigenform with first nonzero coefficient equal to 1. Then all of

the Fourier coefficients of f are contained in a finite extension of \mathbb{Q} , so we consider the field $\mathbb{F}_f = \mathbb{Q}(a_0, a_1, \dots)$. In particular $[\mathbb{F}_f : \mathbb{Q}] < \infty$. Every space M_k of modular forms is finite dimensional, so that if we write a basis as $f_i = \sum a_{n,i} q^n$, then we have that the composition, \mathbb{F} , of all the \mathbb{F}_f is still finite dimensional.

Hence we consider the Galois group G of \mathbb{F} , and define an action of G on f . In particular let $\sigma \in G$ and define:

$$\sigma(f) := \sum \sigma(a_n) q^n$$

Now suppose α is a root of a polynomial f , and let σ be in the Galois group of f . Then $f(\sigma(\alpha)) = \sigma(f(\alpha)) = 0$, so that σ permutes the roots of f , but never takes a root to a nonroot.

Now that we know how to apply a Galois action to a polynomial, one may ask how it interacts with the Hecke operators. In particular, both $T_{n,k}(\sigma(f))$ and $\sigma(T_{n,k}(f))$ make sense and are in fact equal

$$\sigma(T_n f) = T_n \sigma(f)$$

which is clear from the fact that M_k has a rational basis, and σ fixes \mathbb{Q} .

1.11 The Rankin-Cohen Bracket Operator

There are many ways that one may obtain a modular form from other modular forms. Most trivially is just that of multiplication: if f and g are modular forms, we can obtain a new modular form fg , which is of weight $wt(f) + wt(g)$. We will now generalize multiplication to something called the Rankin-Cohen bracket operator.

First let $f^{(a)}$ denote the a^{th} derivative of f , where by derivative we mean the normalized derivative:

$$f^{(1)}(z) = \frac{1}{2\pi i} \frac{d}{dz} f(z).$$

Definition 1.11.1. *The Rankin-Cohen bracket operator $[f, g]_j : M_k \times M_l \rightarrow M_{k+l+2j}$ is given by*

$$[f, g]_j := \sum_{r+s=j} (-1)^a \binom{j+k-1}{s} \binom{j+l-1}{r} f^{(r)}(z) g^{(s)}(z).$$

These are the unique normalized bilinear operators on these spaces. See [25] for more information on these operators.

There are several nice properties of this bracket operator. Some of these will be proved in Chapter 2. In particular, the zeroth bracket, $[\cdot, \cdot]_0$, is merely multiplication. Even brackets are symmetric, while odd brackets are antisymmetric. In particular we have the properties presented in the following lemmas. Lemma 1.11.2 is obvious from the fact that odd brackets are antisymmetric. Lemma 1.11.3 will be proven in chapter 2.

Lemma 1.11.2. *Let f be a modular form. Also let g and h be nonzero modular forms, exactly one of which is cuspidal. Then $[f, f]_{2j+1} = 0$ and $[g, h]_n \neq 0$ for all n .*

Lemma 1.11.3. *Let E_k and E_l be Eisenstein series. Then $[E_k, E_l]_n = 0$ if and only if $k = l$ and n is odd.*

1.12 The Nearly Holomorphic Setting

In the previous section we saw how to construct a new modular form from two modular forms. Now we ask how to construct a new modular form from just one modular form. One attempt along these lines would be to differentiate a modular form. However the derivative of a modular form is not modular. (It is, however, holomorphic).

Consider the derivative of a modular form and add the appropriate term to make the result modular. This extra term is not holomorphic, but is not holomorphic in a very specific manner. Following the terminology of [25] we call these nearly holomorphic modular forms (although not all nearly holomorphic modular forms arise in this way). The specific construction comes from the Maass Shimura Operator whose details follow.

Definition 1.12.1. *We define the Maass-Shimura Operator δ_k on $f \in M_k(\Gamma)$ by*

$$\delta_k(f) = \left(\frac{1}{2\pi i} \left(\frac{k}{2i\text{Im}(z)} + \frac{\partial}{\partial z} \right) f \right) (z).$$

We then define composition as $\delta_l^{(2)} := \delta_{l+2} \circ \delta_l := \left(\frac{1}{2\pi i} \right)^2 \left(\frac{k+2}{2i\text{Im}(z)} + \frac{\partial}{\partial z} \right) \left(\frac{k}{2i\text{Im}(z)} + \frac{\partial}{\partial z} \right)$. Similarly construct $\delta_k^{(r)}$ by iterated composition, and take $\delta_k^{(0)} := id$. A function of the form $\delta_k^{(r)}(f)$ is called a nearly holomorphic modular form of weight $k + 2r$ as in [25]. We call k the holomorphic weight, $2r$ the non-holomorphic weight. Note that two forms of different weight of either type are necessarily different functions.

Now for a modular form f , $\delta_k(f)$ is a nearly holomorphic modular form of weight $k + 2$. However, not all nearly holomorphic modular forms of weight $k + 2$ arise in this way. In particular, consider $\delta_{k-2}^{(2)}(g)$ where g is a modular form of weight $k - 2$. This is completely outside the range of $\delta_k(M_k)$, which contains only forms of holomorphic weight k and non-holomorphic weight 2.

Hence we construct the space of all nearly holomorphic modular forms to be the space generated by all such constructions. Denote this space by $\widetilde{M}_k(\Gamma)$. Because we assume $\Gamma = SL_2(\mathbb{Z})$, we will shorten this to \widetilde{M}_k .

Note that the image of δ_k is contained in \widetilde{M}_{k+2} . Also, the notation $\delta_k^{(r)}(f)$ will only be used when f is in fact a holomorphic modular form.

Now we shall try to illuminate these Maass-Shimura operators a little. In particular as defined δ_k is an operator on M_k , and not explicitly on \widetilde{M}_k . However, recall that everything in \widetilde{M}_k is a linear combination of Maass-Shimura operators applied to modular forms:

$$\sum_{2i=4}^k \delta_{2i}^{(k-i)} f_{2i}$$

where f_{2i} is a weight $2i$ modular form. The map δ_k is defined on this by composing the operators δ_k and δ_{2i}^{k-2i} to obtain

$$\delta_k \sum_{2i=4}^k \delta_{2i}^{(k-i)} f_{2i} = \sum_{2i=4}^k \delta_{2i}^{(k+1-i)} f_{2i}.$$

We will define structures similar to the classical setting in this nearly holomorphic setting. In particular we will define Hecke operators $T_{n,k} : \widetilde{M}_k \rightarrow \widetilde{M}_k$ following [24] as

$$(T_{n,k}(f))(z) = n^{k-1} \sum_{d|n} d^{-k} \sum_{b=0}^{d-1} f\left(\frac{nz+bd}{d^2}\right).$$

As in Section 1.5, there are other ways to formulate the Hecke operator. However, as this definition does not depend on the underlying space, it is the one we shall use to generalize the notion of a Hecke operator.

We define an eigenform identically to the definition in the classical setting, as stated below.

Definition 1.12.2. *A nearly holomorphic modular form f of weight k is an eigenform if it is an eigenvector for $T_{n,k}$ for $n = 1, 2, \dots$*

1.13 Previous Results

Several authors have worked on problems regarding products of eigenforms. This is a similar question, and a special case of divisibility of eigenforms: a first situation to consider. Such an example is our consideration of products of nearly holomorphic modular forms in chapter 2.

The earliest works of this nature are that of Ghate [16] and Duke [9] whom simultaneously and independently solved the problem “When is the product of two eigenforms again an eigenform?” The answer to this question is that the product is an eigenform only when it is trivial. That is: if the dimension of the range is 1, then it is forced to be an eigenform. It turns out that this is also necessary, resulting in exactly 16 cases that the product of eigenforms is again an eigenform.

For example, $\dim(M_{10}) = 1$, and $E_4 \cdot E_6 \in M_{10}$ so that $E_4 \cdot E_6$ is an eigenform because it is forced to be for dimension consideration.

Now this does not address the question of multiple eigenforms. In particular while $E_{12} \cdot E_{22}$ is not an eigenform, maybe if we allow a third factor we can “fix it up” and obtain an eigenform. Emmons and Lanphier [11] showed that this is not the case. In particular they showed that the product of many eigenforms is an eigenform only when it is forced to be for dimension consideration.

There is also a question regarding obtaining eigenforms from the Rankin-Cohen Bracket Operator. In particular Lanphier and Takloo-Bighash [26] showed that the Rankin-Cohen Bracket Operator of two eigenforms is only an eigenform when it is forced to be by dimension consideration.

The attentive reader has probably noticed that all of the previously mentioned work is all of the same nature: something is an eigenform only when it is forced to be by dimension consideration. The present work follows along the same lines: the result is true when it is trivial, and then some work ensues to show that in fact the trivial case is the only case.

While the current work is all in full level, it should be noted that progress has been made on this type of question in higher level. Ghate [17] and Emmons [10] showed for some congruence subgroups that the product of eigenforms is only an eigenform when forced to be, and in a currently unpublished work Johnson [20] showed the same for $\Gamma_1(N)$.

Chapter 2

Results on Nearly Holomorphic Modular Forms

2.1 Introduction

It is well known that the modular forms of a specific weight for the full modular group form a complex vector space, and the action of the algebra of Hecke operators on these spaces has received much attention. For instance, we know that there is a basis for such spaces composed entirely of forms called Hecke eigenforms which are eigenvectors for all of the Hecke operators simultaneously. Since the set of all modular forms (of all weights) for the full modular group can be viewed as a graded complex algebra, it is quite natural to ask if the very special property of being a Hecke eigenform is preserved under multiplication. This problem was studied independently by Ghatge [16] and Duke [9] and they found that it is indeed quite rare that the product of Hecke eigenforms is again a Hecke eigenform. In fact, they proved that there are only a finite number of examples of this phenomenon. Emmons and Lanphier [11] extended these results to an arbitrary number of Hecke eigenforms. The more general question of preservation of eigenforms through the Rankin-Cohen bracket operator (a bilinear form on the graded algebra of modular forms) was studied by Lanphier and Takloo-Bighash [25, 26] and led to a similar conclusion. One can see [31] or [34] for more on these operators.

The work mentioned above focuses on eigenforms which are “new” everywhere. It seems

natural to extend these results to eigenforms which are not new. In this chapter, we consider modular forms which are “old” at infinity in the sense that the form comes from a holomorphic form of lower weight. More precisely, we show that the product of two nearly holomorphic eigenforms is an eigenform for only a finite list of examples (see Theorem 2.3.1). It would also be interesting to consider the analogous question for forms which are old at one or more finite places.

Note that the results in this chapter have been published in the Ramanujan Journal [3], and are joint work not only with my advisors but with a colleague Catherine Trentacoste.

2.2 Nearly Holomorphic Modular Forms

Let $\Gamma = SL_2(\mathbb{Z})$ be the full modular group and let $M_k(\Gamma)$ represent the space of level Γ modular forms of even weight k . Let $f \in M_k(\Gamma)$ and $g \in M_l(\Gamma)$. Throughout k, l will be positive even integers and r, s will be nonnegative integers. Recall that we define the Maass-Shimura operator δ_k on $f \in M_k(\Gamma)$ by

$$\delta_k(f)(z) = \left(\frac{1}{2\pi i} \left(\frac{k}{2i\text{Im}(z)} + \frac{\partial}{\partial z} \right) f \right) (z).$$

Write $\delta_k^{(r)} := \delta_{k+2r-2} \circ \cdots \circ \delta_{k+2} \circ \delta_k$, with $\delta_k^{(0)} = id$. A function of the form $\delta_k^{(r)}(f)$ is called a nearly holomorphic modular form of weight $k + 2r$ as in [25].

Recal that $\widetilde{M}_k(\Gamma)$ denotes the space generated by nearly holomorphic forms of weight k and level Γ .

Note that the image of δ_k is contained in $\widetilde{M}_{k+2}(\Gamma)$. Also, the notation $\delta_k^{(r)}(f)$ will only be used when f is in fact a holomorphic modular form.

We define the Hecke operator $T_n : \widetilde{M}_k(\Gamma) \rightarrow \widetilde{M}_k(\Gamma)$ following [24], as

$$(T_n(f))(z) = n^{k-1} \sum_{d|n} d^{-k} \sum_{b=0}^{d-1} f\left(\frac{nz+bd}{d^2}\right).$$

A modular form (or nearly holomorphic modular form) $f \in \widetilde{M}_k(\Gamma)$ is said to be an eigenform if it is an eigenvector for all the Hecke operators $\{T_n\}_{n \in \mathbb{N}}$.

The Rankin-Cohen bracket operator $[f, g]_j : M_k(\Gamma) \times M_l(\Gamma) \rightarrow M_{k+l+2j}(\Gamma)$ is given by

$$[f, g]_j(z) := \frac{1}{(2\pi i)^j} \sum_{a+b=j} (-1)^a \binom{j+k-1}{b} \binom{j+l-1}{a} f^{(a)}(z) g^{(b)}(z)$$

where $f^{(a)}$ denotes the a^{th} derivative of f .

Proposition 2.2.1 ([3], Prop 2.2). *Let $f \in M_k(\Gamma)$, $g \in M_l(\Gamma)$. Then*

$$\delta_k^{(r)}(f)\delta_l^{(s)}(g) = \sum_{j=0}^s (-1)^j \binom{s}{j} \delta_{k+l+2r+2j}^{(s-j)} \left(\delta_k^{(r+j)}(f)g \right).$$

Proof. Note that, $\delta_{k+l+2r} \left(\delta_k^{(r)}(f)g \right) = \delta_k^{(r+1)}(f)g + \delta_k^{(r)}(f)\delta_l(g)$, and use induction on s . \square

Combining the previous proposition and the Rankin-Cohen bracket operator gives us the following expansion of a product of nearly holomorphic modular forms.

Proposition 2.2.2 ([3], Prop 2.3). *Let $f \in M_k(\Gamma)$, $g \in M_l(\Gamma)$. Then*

$$\delta_k^{(r)}(f)\delta_l^{(s)}(g)(z) = \sum_{j=0}^{r+s} \frac{1}{\binom{k+l+2j-2}{j}} \left(\sum_{m=\max(j-r,0)}^s (-1)^{j+m} \frac{\binom{s}{m} \binom{r+m}{j} \binom{k+r+m-1}{r+m-j}}{\binom{k+l+r+m+j-1}{r+m-j}} \right) \delta_{k+l+2j}^{(r+s-j)} ([f, g]_j(z)).$$

Proof. Lanphier [25, Theorem 1] gave the following formula:

$$\delta_k^{(n)}(f(z)) \times g(z) = \sum_{j=0}^n \frac{(-1)^j \binom{n}{j} \binom{k+n-1}{n-j}}{\binom{k+l+2j-2}{j} \binom{k+l+n+j-1}{n-j}} \delta_{k+l+2j}^{(n-j)} ([f, g]_j(z)).$$

Substituting this into the equation in Proposition 2.2.1, we obtain

$$\delta_k^{(r)}(f)\delta_l^{(s)}(g)(z) = \sum_{m=0}^s (-1)^m \binom{s}{m} \delta_{k+l+2r+2m}^{(s-m)} \left[\sum_{j=0}^{r+m} \frac{(-1)^j \binom{r+m}{j} \binom{k+r+m-1}{r+m-j}}{\binom{k+l+2j-2}{j} \binom{k+l+r+m+j-1}{r+m-j}} \delta_{k+l+2j}^{(r+m-j)} ([f, g]_j(z)) \right].$$

Rearranging this sum we obtain the proposition. \square

We will also use the following proposition which shows how δ_k and T_n almost commute.

Proposition 2.2.3 ([3], Prop 2.4). *Let $f \in M_k(\Gamma)$. Then*

$$\left(\delta_k^{(m)}(T_n f) \right) (z) = \frac{1}{n^m} \left(T_n \left(\delta_k^{(m)}(f) \right) \right) (z)$$

where $m \geq 0$.

Proof. Write $F(z) = f\left(\frac{nz+bd}{d^2}\right)$. Note that $\frac{\partial}{\partial z}(F(z)) = \frac{n}{d^2} \frac{\partial f}{\partial z}\left(\frac{nz+bd}{d^2}\right)$, so that

$$\begin{aligned}\delta_k(T_n f)(z) &= n^{k-1} \sum_{d|n} d^{-k} \sum_{b=0}^{d-1} \left(\frac{1}{2\pi i}\right) \left[\frac{k}{2i\text{Im}(z)} F(z) + \frac{\partial}{\partial z}(F(z)) \right] \\ &= n^{k-1} \sum_{d|n} d^{-k} \sum_{b=0}^{d-1} \left(\frac{1}{2\pi i}\right) \left[\frac{k}{2i\text{Im}(z)} f\left(\frac{nz+bd}{d^2}\right) + \frac{n}{d^2} \frac{\partial f}{\partial z}\left(\frac{nz+bd}{d^2}\right) \right].\end{aligned}$$

Next one computes that

$$T_n(\delta_k(f))(z) = n \left[n^{k-1} \sum_{d|n} d^{-k} \sum_{b=0}^{d-1} \left(\frac{1}{2\pi i}\right) \left(\frac{k}{2i\text{Im}(z)} f\left(\frac{nz+bd}{d^2}\right) + \frac{n}{d^2} \frac{\partial f}{\partial z}\left(\frac{nz+bd}{d^2}\right) \right) \right]$$

from which we see

$$(\delta_k(T_n f))(z) = \frac{1}{n} (T_n(\delta_k(f)))(z).$$

Now induct on m . □

We would like to show that a sum of eigenforms of distinct weight can only be an eigenform if each form has the same set of eigenvalues. In order to prove this, we need to know the relationship between eigenforms and nearly holomorphic eigenforms.

Proposition 2.2.4 ([3], Prop 2.5). *Let $f \in M_k(\Gamma)$. Then $\delta_k^{(r)}(f)$ is an eigenform for T_n if and only if f is. In this case, if λ_n denotes the eigenvalue of T_n associated to f , then the eigenvalue of T_n associated to $\delta_k^{(r)}(f)$ is $n^r \lambda_n$.*

Proof. Assume f is an eigenform. So $(T_n f)(z) = \lambda_n f(z)$. Then applying $\delta_k^{(r)}$ to both sides and applying Proposition 2.2.3 we obtain the following:

$$T_n(\delta_k^{(r)}(f))(z) = n^r \lambda_n (\delta_k^{(r)}(f))(z).$$

So $\delta_k^{(r)}(f)$ is an eigenform.

Now assume that $\delta_k^{(r)}(f)$ is an eigenform. Then $T_n(\delta_k^{(r)}(f))(z) = \lambda_n (\delta_k^{(r)}(f))(z)$. Using

Proposition 2.2.3, we obtain $\delta_k^{(r)}(T_n f)(z) = \frac{\lambda_n}{n^r} \delta_k^{(r)}(f)(z) = \delta_k^{(r)}\left(\frac{\lambda_n}{n^r} f\right)(z)$. Since $\delta_k^{(r)}$ is injective,

$$(T_n f)(z) = \frac{\lambda_n}{n^r} f(z).$$

Hence f is an eigenform. □

Now our result on a sum of eigenforms with distinct weights follow.

Proposition 2.2.5 ([3], Prop 2.6). *Suppose that $\{f_i\}_i$ is a collection of modular forms with distinct weights k_i . Then $\sum_{i=1}^t a_i \delta_{k_i}^{(n-\frac{k_i}{2})}(f_i)$ ($a_i \in \mathbb{C}^*$) is an eigenform if and only if every $\delta_{k_i}^{(n-\frac{k_i}{2})}(f_i)$ is an eigenform and each function has the same set of eigenvalues.*

Proof. By induction we only need to consider $t = 2$.

(\Leftarrow) : If $T_n(\delta_k^{(r)}(f)) = \lambda \delta_k^{(r)}(f)$, and $T_n(\delta_l^{(\frac{k-l}{2}+r)}(g)) = \lambda \delta_l^{(\frac{k-l}{2}+r)}(g)$, then by linearity of T_n ,

$$T_n\left(\delta_k^{(r)}(f) + \delta_l^{(\frac{k-l}{2}+r)}(g)\right) = \lambda\left(\delta_k^{(r)}(f) + \delta_l^{(\frac{k-l}{2}+r)}(g)\right).$$

(\Rightarrow) : Suppose $\delta_k^{(r)}(f) + \delta_l^{(\frac{k-l}{2}+r)}(g)$ is an eigenform. Then by Proposition 2.2.4 and linearity of $\delta_k^{(r)}$, $f + \delta_l^{(\frac{k-l}{2})}(g)$ is also an eigenform. Write

$$T_n\left(f + \delta_l^{(\frac{k-l}{2})}(g)\right) = \lambda_n\left(f + \delta_l^{(\frac{k-l}{2})}(g)\right).$$

Applying linearity of T_n and Proposition 2.2.3 this is

$$T_n(f) + n^{\frac{k-l}{2}} \delta_l^{(\frac{k-l}{2})}(T_n(g)) = \lambda_n f + \lambda_n \delta_l^{(\frac{k-l}{2})}(g).$$

Rearranging this we get

$$T_n(f) - \lambda_n f = \delta_l^{(\frac{k-l}{2})}\left(\lambda_n g - n^{\frac{k-l}{2}} T_n(g)\right).$$

Now note that the left hand side is holomorphic and of positive weight, and that the right hand side is either nonholomorphic or zero, since the δ operator sends all nonzero modular forms to

so called nearly holomorphic modular forms. Hence both sides must be zero. Thus we have

$$T_n(f) = \lambda_n f \text{ and } T_n(g) = \lambda_n n^{-\frac{(k-l)}{2}} g.$$

Therefore f is an eigenvector for T_n with eigenvalue λ_n , and g is an eigenvector for T_n with eigenvalue $\lambda_n n^{-\frac{(k-l)}{2}}$. By Proposition 2.2.4 we have that $\delta_l^{\left(\frac{k-l}{2}\right)}(g)$ is an eigenvector for T_n with eigenvalue λ_n . Therefore f and $\delta_l^{\left(\frac{k-l}{2}\right)}(g)$ are eigenvectors for T_n with eigenvalue λ_n . So $\delta_k^{(r)}(f)$ and $\delta_l^{\left(\frac{k-l}{2}+r\right)}(g)$ must have the same eigenvalue with respect to T_n as well. Hence $\delta_k^{(r)}(f)$ and $\delta_l^{\left(\frac{k-l}{2}+r\right)}(g)$ must be eigenforms with the same eigenvalues. □

Using the above proposition we can show that when two holomorphic eigenforms of different weights are mapped to the same space of nearly holomorphic modular forms that different eigenvalues are obtained.

Lemma 2.2.6 ([3], Lemma 2.7). *Let $l < k$ and $f \in M_k(\Gamma), g \in M_l(\Gamma)$ both be eigenforms. Then $\delta_l^{\left(\frac{k-l}{2}\right)}(g)$ and f do not have the same eigenvalues.*

Proof. Suppose they do have the same eigenvalues. That is, say g has eigenvalues $\lambda_n(g)$, then by Proposition 2.2.4 we are assuming that f has eigenvalues $n^{\frac{k-l}{2}} \lambda_n(g)$. We then have from multiplicity one there are constants c, c_0 such that

$$\begin{aligned} f(z) &= \sum_{n=1}^{\infty} c n^{\frac{k-l}{2}} \lambda_n(g) q^n + c_0 \\ &= \frac{1}{(2\pi i)^{(k-l)/2}} \frac{\partial^{(k-l)/2}}{\partial z^{(k-l)/2}} \sum_{n=1}^{\infty} c \lambda_n(g) q^n + c_0 \\ &= \frac{1}{(2\pi i)^{(k-l)/2}} \frac{\partial^{(k-l)/2}}{\partial z^{(k-l)/2}} g(z) + c_0 \end{aligned}$$

which says that f is a derivative of g plus a possibly zero constant. However, from direct computation, this is not modular. Hence we have a contradiction. □

We shall need a special case of this lemma.

Corollary 2.2.7 ([3], Cor 2.8). *Let $k > l$ and $f \in M_k(\Gamma), g \in M_l(\Gamma)$. Then $\delta_l^{\left(\frac{k-l}{2}+r\right)}(g)$ and $\delta_k^{(r)}(f)$ do not have the same eigenvalues.*

From [26] we know that for eigenforms f, g , that $[f, g]_j$ is an eigenform only finitely many times. Hypothetically, however, it could be zero. In particular by the fact that $[f, g]_j = (-1)^j [g, f]_j$, $f = g$ and j odd gives $[f, g]_j = 0$. Hence we need the following lemma, where E_k denotes the weight k Eisenstein series normalized to have constant term 1.

Lemma 2.2.8 ([3], Lemma 2.9). *Let $\delta_k^{(r)}(f) \in \widetilde{M}_{k+2r}(\Gamma)$, $\delta_l^{(s)}(g) \in \widetilde{M}_{l+2s}(\Gamma)$. In the following cases $[f, g]_j \neq 0$:*

Case 1: f a cusp form, g not a cusp form.

Case 2: $f = g = E_k$, j even.

Case 3: $f = E_k, g = E_l$, $k \neq l$.

Proof. Case 1: Write $f = \sum_{j=1}^{\infty} A_j q^j, g = \sum_{j=0}^{\infty} B_j q^j$. Then a direct computation of the q -coefficient of $[f, g]_j$ yields

$$A_1 B_0 (-1)^j \binom{j+k-1}{j} \neq 0.$$

Case 2: Using the same notation, a direct computation of the q coefficient yields

$$A_0 B_1 \binom{j+l-1}{j} + A_1 B_0 \binom{j+k-1}{j} = 2A_0 A_1 \binom{j+k-1}{j} \neq 0.$$

Case 3: This is proven in [26] using L -series. We provide an elementary proof here. Without loss of generality, let $k > l$. A direct computation of the q coefficient yields $A_0 B_1 \binom{j+l-1}{j} + A_1 B_0 \binom{j+k-1}{j}$. Using the fact that $A_0 = B_0 = 1$, $A_1 = k/B_k$, $B_1 = l/B_l$, we obtain

$$\frac{-2l}{B_l} \binom{j+k-1}{j} + (-1)^j \frac{-2k}{B_k} \binom{j+l-1}{j}.$$

If j is even, then both of these terms are nonzero and of the same sign. If j is odd, then we note that for $l > 4$,

$$\left| \frac{B_k}{k} \binom{j+k-1}{j} \right| = \left| \frac{(j+k-1) \cdots (k+1) B_k}{j!} \right| > \left| \frac{(j+l-1) \cdots (l+1) B_l}{j!} \right| = \left| \frac{B_l}{l} \binom{j+l-1}{j} \right|$$

using the fact that $|B_k| > |B_l|$ for $l > 4$, l even. For $l = 4$, the inequality holds so long as $j > 1$. For $j = 1$ the above equation simplifies to $|B_k| > |B_l|$ which is true for $(k, l) \neq (8, 4)$, with this remaining cases handled individually. For $j = 0$, the Rankin-Cohen bracket operator reduces to multiplication. \square

We will need the fact that a product is not an eigenform, given in the next lemma.

Lemma 2.2.9 ([3], Lemma 2.10). *Let $\delta_k^{(r)}(f) \in \widetilde{M}_{k+2r}(\Gamma)$, $\delta_l^{(s)}(g) \in \widetilde{M}_{l+2s}(\Gamma)$ both be cuspidal eigenforms. Then $\delta_k^{(r)}(f)\delta_l^{(s)}(g)$ is not an eigenform.*

Proof. By Proposition 2.2.2 we may write $\delta_k^{(r)}(f)\delta_l^{(s)}(g)$ as a linear combination of $\delta_{k+l+2j}^{(r+s-j)}([f, g]_j)$. Then from [26], $[f, g]_j$ is never an eigenform. Hence by Proposition 2.2.4, $\delta_{k+l+2j}^{(r+s-j)}([f, g]_j)$ is never an eigenform. Finally Proposition 2.2.5 tells us that the sum, and thus $\delta_k^{(r)}(f)\delta_l^{(s)}(g)$ is not an eigenform. \square

Finally, this last lemma is the driving force in the main result to come: one of the first two terms from Proposition 2.2.2 is nonzero.

Lemma 2.2.10 ([3], Lemma 2.11). *Let $\delta_k^{(r)}(f) \in \widetilde{M}_{k+2r}(\Gamma)$, $\delta_l^{(s)}(g) \in \widetilde{M}_{l+2s}(\Gamma)$ both be eigenforms, but not both cusp forms. Then in the expansion given in Proposition 2.2.2, either the term including $[f, g]_{r+s}$ is nonzero, or the term including $[f, g]_{r+s-1}$ is nonzero.*

Proof. There are three cases.

Case 1: $f = g = E_k$. If $r + s$ is even, then via Lemma 2.2.8, $[f, g]_{r+s} \neq 0$ and it is clear from Proposition 2.2.2 that the coefficient of $[f, g]_{r+s}$ is nonzero so we are done. If $r + s$ is odd, then $[f, g]_{r+s-1}$ is nonzero. Now because $wt(f) = wt(g)$, the coefficient of $[f, g]_{r+s-1}$ is nonzero. This is due to the fact that if it were zero, after simplification we would have $k = -(r + s) + 1 \leq 0$, which cannot occur.

Case 2: If f is a cusp form and g is not then by Lemma 2.2.8, $[f, g]_{r+s}$, and thus the term including $[f, g]_{r+s}$ is nonzero.

Case 3: If $f = E_k$, $g = E_l$, $k \neq l$. Again by Lemma 2.2.8, $[f, g]_{r+s}$, and thus the term including $[f, g]_{r+s}$ is nonzero. \square

2.3 Main Result

Recall that E_k is a weight k Eisenstein series, and let Δ_k be the unique normalized cuspidal form of weight k for $k \in \{12, 16, 18, 20, 22, 26\}$. We have the following theorem.

Theorem 2.3.1 ([3], Thm 3.1). *Let $\delta_k^{(r)}(f) \in \widetilde{M}_{k+2r}(\Gamma)$ and $\delta_l^{(s)}(g) \in \widetilde{M}_{l+2s}(\Gamma)$ both be eigenforms. Then $\delta_k^{(r)}(f)\delta_l^{(s)}(g)$ is not a eigenform aside from finitely many exceptions. In particular $\delta_k^{(r)}(f)\delta_l^{(s)}(g)$ is a eigenform only in the following cases:*

1. The 16 holomorphic cases presented in [9] and [16]:

$$E_4^2 = E_8, \quad E_4 E_6 = E_{10}, \quad E_6 E_8 = E_4 E_{10} = E_{14},$$

$$E_4 \Delta_{12} = \Delta_{16}, \quad E_6 \Delta_{12} = \Delta_{18}, \quad E_4 \Delta_{16} = E_8 \Delta_{12} = \Delta_{20},$$

$$E_4 \Delta_{18} = E_6 \Delta_{16} = E_{10} \Delta_{12} = \Delta_{22},$$

$$E_4 \Delta_{22} = E_6 \Delta_{20} = E_8 \Delta_{18} = E_{10} \Delta_{12} = E_{14} \Delta_{12} = \Delta_{26}.$$

2. $\delta_4(E_4) \cdot E_4 = \frac{1}{2} \delta_8(E_8)$

Proof. By Proposition 2.2.2 we may write

$$\delta_k^{(r)}(f) \delta_l^{(s)}(g) = \sum_{j=0}^{r+s} \alpha_j \delta_{k+l+2j}^{(r+s-j)}([f, g]_j).$$

Now, by Proposition 2.2.5 this sum is an eigenform if and only if every summand is an eigenform with a single common eigenvalue or is zero. Note that by Corollary 2.2.7, $\alpha_j \delta_{k+l+2j}^{(r+s-j)}([f, g]_j)$ are always of different eigenvalues for different j . Hence for $\delta_k^{(r)}(f) \delta_l^{(s)}(g)$ to be an eigenform, all but one term in the summation must be zero and the remaining term must be an eigenform.

If both f, g are cusp forms, apply Lemma 2.2.9. Otherwise from Lemma 2.2.10 either the term including $[f, g]_{r+s}$ or the term including $[f, g]_{r+s-1}$ is nonzero. By [26] this is an eigenform only finitely many times. Hence there are only finitely many f, g, r, s that yield the entire sum, $\delta_k^{(r)}(f) \delta_l^{(s)}(g)$, an eigenform. Each of these finitely many quadruples were enumerated and all eigenforms found. See the following comments for more detail. \square

Remark 2.3.2. *In general $2\delta_k(E_k) \cdot E_k = \delta_{2k}(E_k^2)$. However, for $k \neq 4$, this is not an eigenform.*

Once we know that $\delta_k^{(r)}(f) \delta_l^{(s)}(g)$ is in general not an eigenform, we have to rule out the last finitely many cases. In particular consider each eigenform (and zero) as leading term $[f, g]_n$ in Proposition 2.2.2. From [26] we know that there are 29 cases with g a cusp form (12 with $n = 0$), 81 cases with f, g both Eisenstein series (4 with $n = 0$). By case we mean instance of $[f, g]_n$ that is an eigenform. We also must consider the infinite class with $f = g = E_k$ and $r + s$ odd, where $[f, g]_{r+s} = 0$.

For the infinite class when $f = g$ and $r + s$ is odd we do have $[f, g]_{r+s} = 0$. By Lemma 2.2.10 the $[f, g]_{r+s-1}$ term is nonzero. If $r + s - 1 = 0$, then this is covered in the $n = 0$ case. Otherwise $r + s - 1 \geq 2$. This is an eigenform only finitely many times. In each of these cases one computes that the $[f, g]_0$ term is nonzero. Thus because there are two nonzero terms, $\delta_k^{(r)}(f)\delta_l^{(s)}(g)$ is not an eigenform.

The 16 cases with $n = 0$ are the 16 holomorphic cases. Now consider the rest. In the last finitely many cases we find computationally that there are two nonzero coefficients: the coefficient of $[f, g]_0$, and $[f, g]_{r+s}$. Now $[f, g]_0 \neq 0, [f, g]_{r+s} \neq 0$ and so in these cases $\delta_k^{(r)}(f)\delta_l^{(s)}(g)$ is not an eigenform.

The typical case, however, will involve many nonzero terms such as

$$\begin{aligned}\delta_4(E_4) \cdot \delta_4(E_4) &= \frac{-1}{45}[E_4, E_4]_2 + 0 \cdot \delta_{10}([E_4, E_4]_1) + \frac{10}{45}\delta_8^{(2)}([E_4, E_4]_0) \\ &= \frac{-1}{45} \left(42 \cdot E_4 \frac{\partial^2}{\partial z^2} E_4 - 49 \left(\frac{\partial}{\partial z} E_4 \right)^2 \right) + \frac{10}{45}\delta_8^{(2)}(E_8),\end{aligned}$$

$$\delta_6(E_6) \cdot E_8 = \frac{-1}{14}[E_6, E_8]_1 + \frac{3}{7}\delta_{14}([E_6, E_8]_0) = \frac{-1}{14} \left(6E_6 \frac{\partial}{\partial z} E_8 - 8E_8 \frac{\partial}{\partial z} E_6 \right) + \frac{3}{7}\delta_{14}(E_6 E_8)$$

which cannot be eigenforms because of the fact that there are multiple terms of different holomorphic weight.

Chapter 3

Divisibility of an Eigenform by another Eigenform

3.1 Introduction and Statement of Main Results

There have been several works regarding the factorization of eigenforms for the full modular group $\Gamma = SL_2(\mathbb{Z})$. In particular Rankin [30] considered products of Eisenstein series. Independently Duke [9] and Ghatge [16] show that the product of two eigenforms is an eigenform in only finitely many cases. More generally Emmons and Lanphier [11] show that the product of any number of eigenforms is an eigenform only finitely many times. The present chapter will consider a factorization that allows one factor to be any modular form. The results in this chapter are joint work with my advisors Kevin James and Hui Xue; the corresponding paper has been accepted pending revisions which are currently under review by the proceedings of the American Mathematical Society.

It is shown in Sections 3.2, 3.3, and 3.4 that given some technical conditions the only eigenforms that can divide other eigenforms come from one dimensional spaces. This is a corollary of Theorems 3.1.3, 3.1.4, and 3.1.5.

Corollary 3.1.1. *If $T_n(x)$ and $\varphi_k(x)$ are irreducible over appropriately small fields, then the only eigenforms that divide other eigenforms come from one dimensional spaces: $M_4, M_6, M_8, M_{10}, S_{12}, M_{14}, S_{16}, S_{18}, S_{20}, S_{22}$ and S_{26} .*

Recall that there is a basis of eigenforms for the space S_k of cuspforms of weight k on

$SL_2(\mathbb{Z})$. Together S_k and the Eisenstein series E_k generate the full space M_k of modular forms of weight k . Further, every noncuspidal eigenform is an Eisenstein series. Additionally, a basis of eigenforms is necessarily an orthogonal basis under the Petersson inner product [8, p. 163]. For more information on these topics, see any basic text on modular forms, such as [8] or [23].

In this chapter we investigate an eigenform h divided by an eigenform f with quotient g which is a modular form. That is,

$$h = fg. \tag{3.1.2}$$

Without loss of generality we assume that all eigenforms considered are normalized so that the first nonzero coefficient is one. The dividend h could be either cuspidal, or an Eisenstein series. Likewise the divisor f could be either cuspidal or an Eisenstein series. It is impossible to divide an Eisenstein series by a cuspidal eigenform and obtain a quotient which is again a modular form (or even holomorphic), so our problem naturally breaks into three cases to consider,

Case (1) Both the dividend h and divisor f are cuspidal eigenforms.

Case (2) The dividend h is a cuspidal eigenform, but the divisor f is an Eisenstein series.

Case (3) Both the dividend h and divisor f are Eisenstein series.

Each of these cases leads to a theorem related to the factorization of some polynomials. In Cases 1 and 2 these polynomials are the characteristic polynomials, $T_{n,k}(x)$, of the n^{th} Hecke operator of weight k . In the third case this polynomial is the Eisenstein polynomial $\varphi_k(x)$, whose roots are the j -zeroes of the weight k Eisenstein series E_k (See Definition 1.3.4).

In Case 1, both dividend h and divisor f are cuspidal eigenforms. In this case the quotient g cannot be cuspidal. The following theorem gives a comparison of the dimension of $S_{wt(h)}$ and $M_{wt(g)}$, the spaces which contain the dividend h and quotient g , respectively.

Theorem 3.1.3. *Suppose a cuspidal eigenform f divides another cuspidal eigenform h with quotient g a modular form. Then either $\dim(S_{wt(h)}) = \dim(M_{wt(g)})$ or for every $n \geq 2$, $T_{n,wt(h)}(x)$ is reducible over the field \mathbb{F}_f (See Definition 3.2.1 for \mathbb{F}_f).*

In Case 2, the divisor f is an Eisenstein series, but the dividend h is still a cuspidal modular form. Hence the quotient g must be cuspidal. In this case our result is as follows.

Theorem 3.1.4. *Suppose an Eisenstein series f divides a cuspidal eigenform h with quotient g a modular form. Then either $\dim(S_{wt(h)}) = \dim(S_{wt(g)})$ or for every $n \geq 2$, $T_{n,wt(h)}(x)$ is reducible over \mathbb{Q} .*

In Case 3, the dividend h is an Eisenstein series, and so the quotient g must be noncuspidal. In this case in place of the Hecke polynomial we are led to consider the Eisenstein polynomial $\varphi_k(x)$ of weight k (See Definition 1.3.4). Our result is as follows.

Theorem 3.1.5. *Suppose an Eisenstein series f divides another Eisenstein series h with quotient g a modular form. Then either $\dim(M_{wt(h)}) = \dim(M_{wt(g)})$ or the polynomial $\varphi_{wt(h)}(x)$ is reducible over \mathbb{Q} .*

In each of the above theorems there is either an equality of the dimensions of the appropriate spaces, or information about the factorization of a certain polynomial, $T_{n,wt(h)}(x)$ or $\varphi_{wt(h)}(x)$. For small weights it is known that these polynomials do not factor, and so the dividend h and quotient g must come from spaces of the same dimension. For higher weights it is conjectured that this is still the case. See Section 3.6 for details.

3.2 Proof of Theorem 3.1.3

Theorem 3.1.3 tells us that if we write $h = fg$ where h and f are cuspidal eigenforms, then either $T_{n,wt(h)}(x)$ is reducible over \mathbb{F}_f , the field generated by the Fourier coefficients of f , or $\dim(S_{wt(h)}) = \dim(M_{wt(g)})$.

We now present the formal definition of \mathbb{F}_f .

Definition 3.2.1. *Given a normalized eigenform f , let \mathbb{F}_f denote the field generated over \mathbb{Q} by its Fourier coefficients. That is, if $f = \sum_{n \geq 0} a_n q^n$ then $\mathbb{F}_f = \mathbb{Q}(a_0, a_1, a_2, \dots)$.*

Recall that \mathbb{F}_f/\mathbb{Q} is a finite extension and $\dim(\mathbb{F}_f) \leq \dim(S_{wt(f)})$ [32, p. 81].

The following special subspaces of S_k will play an important role in our proofs.

Definition 3.2.2. *Let $\mathbb{F} \subseteq \mathbb{C}$ be a field. A subspace $S \subseteq S_k$ is said to be \mathbb{F} -rational if it is stable under the action of $\text{Gal}(\mathbb{C}/\mathbb{F})$, i.e. $\sigma(S) = S$ for all $\sigma \in \text{Gal}(\mathbb{C}/\mathbb{F})$. Here we define the action of an automorphism σ on modular forms through their Fourier coefficients.*

We consider such spaces to obtain information about the Hecke polynomials. The following crucial lemma gives a condition guaranteeing all of the Hecke polynomials for a certain weight are reducible.

Lemma 3.2.3. *If S is a proper \mathbb{F} -rational subspace of S_k and S contains an eigenform, then all the Hecke polynomials of weight k are reducible over \mathbb{F} .*

In all known cases the Hecke polynomials $T_{n,k}(x)$ are irreducible. Hence the contrapositive is more practical.

Corollary 3.2.4. *If for some n , $T_{n,k}(x)$ is irreducible over \mathbb{F} , then no proper \mathbb{F} -rational subspace of S_k contains an eigenform.*

We now prove Lemma 3.2.3.

Proof of Lemma 3.2.3. Let $S \subset S_k$ be a proper \mathbb{F} -rational subspace containing an eigenform h . Then define

$$R := \langle \sigma(h) \mid \sigma \in \text{Gal}(\mathbb{C}/\mathbb{F}) \rangle_{\mathbb{C}} \leq S,$$

which is also a proper \mathbb{F} -rational subspace of S_k . Then $S_k = R \oplus R^\perp$, both of which are proper and stable under the action of the Hecke operators because they have eigenform bases. Denote by $T_{n,k}|_R(x)$ the characteristic polynomial of $T_{n,k}$ restricted to R . Note that $T_{n,k}(x) = T_{n,k}|_R(x) \cdot T_{n,k}|_{R^\perp}(x)$. Since R is \mathbb{F} -rational, $T_{n,k}|_R(x) \in \mathbb{F}[x]$. Also $T_{n,k}(x) \in \mathbb{F}[x]$ (actually $T_{n,k}(x) \in \mathbb{Z}[x]$). So $T_{n,k}|_{R^\perp}(x) \in \mathbb{F}[x]$. Therefore $T_{n,k}(x)$ is reducible over \mathbb{F} for all n . \square

We are now ready to prove Theorem 3.1.3.

Proof of Theorem 3.1.3. Suppose we have the factorization $h = fg$ where f and h are cuspidal eigenforms. Then because dimension cannot decrease when multiplying modular forms, $\dim(S_{wt(h)}) \geq \dim(M_{wt(g)})$. If $\dim(S_{wt(h)}) = \dim(M_{wt(g)})$, the proof is complete. So we assume $\dim(S_{wt(h)}) > \dim(M_{wt(g)})$. Let $\{g_1, \dots, g_b\}$ be a rational basis of $S_{wt(g)}$. Then the space $fM_{wt(g)} = \langle fE_{wt(g)}, fg_1, fg_2, \dots, fg_b \rangle$ is an \mathbb{F}_f -rational subspace of $S_{wt(h)}$ of dimension $\dim(M_{wt(g)})$. Because $\dim(S_{wt(h)}) > \dim(M_{wt(g)})$, it is a proper \mathbb{F}_f -rational subspace of $S_{wt(h)}$. On the other hand, this space contains an eigenform $h = fg$. Hence by Lemma 3.2.3 we know that $T_{n,wt(h)}(x)$ is reducible over \mathbb{F}_f for all n . \square

From the dimension formula [8] for spaces of modular forms we find that $\dim(S_{wt(h)}) = \dim(M_{wt(g)})$ occurs only as in the following cases.

Lemma 3.2.5. *Write $h = fg$ where h and f are both cuspidal eigenforms. Then $\dim(S_{wt(h)}) = \dim(M_{wt(g)})$ in only the following cases.*

$$wt(f) = 12, wt(g) \equiv 4, 6, 8, 10, 12, 14 \pmod{12},$$

$$wt(f) = 16, wt(g) \equiv 4, 6, 10, 12 \pmod{12},$$

$$wt(f) = 18, wt(g) \equiv 4, 8, 12 \pmod{12},$$

$$wt(f) = 20, wt(g) \equiv 6, 12 \pmod{12},$$

$$wt(f) = 22, wt(g) \equiv 4, 12 \pmod{12},$$

$$wt(f) = 26, wt(g) \equiv 12 \pmod{12},$$

On the other hand if $\dim(S_{wt(h)}) = \dim(M_{wt(g)})$, Lemma 3.2.5 implies that $wt(f)$ is one of 12, 16, 18, 20, 22, or 26. Thus $\dim(S_{wt(f)}) = 1$. In these cases we can use linear algebra to construct a factorization $h = fg$. In particular the basis $\{E_{wt(g)}, g_1, \dots, g_b\}$ of $M_{wt(g)}$ maps to the basis $\{fE_{wt(g)}, fg_1, \dots, fg_b\}$ of $S_{wt(h)}$ so that everything including the eigenforms in $S_{wt(h)}$ has a factor of f . Also note that if $\dim(S_{wt(h)}) = 1$, then the above reduces into the cases that are treated in [9] and [16].

Corollary 3.2.6. *If $h = fg$ with h and f cuspidal eigenforms and for some n , $T_{n,wt(h)}(x)$ is irreducible over every field \mathbb{F} of degree less than $\dim(S_{wt(h)})$, then f comes from a one dimensional space, i.e. $wt(f) = 12, 16, 18, 20, 22, 26$.*

We note that while part of the hypothesis regarding $T_{n,k}(x)$ used in the above corollary may appear strange, it follows from Maeda's Conjecture [19], see Section 3.6.

3.3 Proof of Theorem 3.1.4

Theorem 3.1.4 tells us that if we write $h = fg$ where h is a cuspidal eigenform and f is an Eisenstein series, then either $T_{n,wt(h)}(x)$ is reducible over \mathbb{Q} or $\dim(S_{wt(h)}) = \dim(S_{wt(g)})$.

Proof of Theorem 3.1.4. Suppose we have a factorization $h = fg$ where h is a cuspidal eigenform and f is an Eisenstein series. Then because dimension cannot decrease when multiplying modular forms, $\dim(S_{wt(h)}) \geq \dim(S_{wt(g)})$. If $\dim(S_{wt(h)}) = \dim(S_{wt(g)})$, the proof is complete. So we assume $\dim(S_{wt(h)}) > \dim(S_{wt(g)})$. Let $\{g_1, \dots, g_b\}$ be a rational basis of $S_{wt(g)}$. Then the space $fS_{wt(g)} =$

$\langle fg_1, \dots, fg_b \rangle$ is a rational subspace of $S_{wt(h)}$ of dimension $\dim(S_{wt(g)})$. Because $\dim(S_{wt(h)}) > \dim(S_{wt(g)})$, it is a proper rational subspace of $S_{wt(h)}$. On the other hand, this space contains an eigenform $h = fg$. Hence by Lemma 3.2.3 we know that $T_{n, wt(h)}(x)$ is reducible over \mathbb{Q} for all n . \square

From the dimension formula [8] for spaces of modular forms we find that $\dim(S_{wt(h)}) = \dim(S_{wt(g)})$ occurs only in the following cases.

Lemma 3.3.1. *Write $h = fg$ where h is a cuspidal eigenform and f is an Eisenstein series. Then $\dim(S_{wt(h)}) = \dim(S_{wt(g)})$ in only the following cases:*

$$wt(f) = 4, wt(g) \equiv 0, 4, 6, 10 \pmod{12},$$

$$wt(f) = 6, wt(g) \equiv 0, 4, 8 \pmod{12},$$

$$wt(f) = 8, wt(g) \equiv 0, 6 \pmod{12},$$

$$wt(f) = 10, wt(g) \equiv 0, 4 \pmod{12},$$

$$wt(f) = 14, wt(g) \equiv 0 \pmod{12},$$

On the other hand if $\dim(S_{wt(h)}) = \dim(S_{wt(g)})$, Lemma 3.3.1 implies that $wt(f)$ is one of 4, 6, 8, 10, or 14. Thus $\dim(M_{wt(f)}) = 1$. In these cases we can use linear algebra to construct a factorization $h = fg$. In particular the basis $\{g_1, \dots, g_b\}$ of $S_{wt(g)}$ maps to the basis $\{fg_1, \dots, fg_b\}$ of $S_{wt(h)}$ so that everything including the eigenforms in $S_{wt(h)}$ has a factor of f . Also note that if $\dim(S_{wt(h)}) = 1$, then the above reduces to the cases that are treated in [9] and [16].

Corollary 3.3.2. *Let $h = fg$ with h a cuspidal eigenform, f an Eisenstein series and for some n , $T_{n, wt(h)}(x)$ be irreducible over \mathbb{Q} . Then, f comes from a one dimensional space. i.e. $wt(f) = 4, 6, 8, 10, 14$.*

Again we note the connection of our hypothesis to Maeda's Conjecture [19], see Section 3.6.

3.4 Proof of Theorem 3.1.5

Theorem 3.1.5 tells us that if we write $h = fg$ where h and f are both Eisenstein series, then either the Eisenstein polynomial $\varphi_{wt(h)}(x)$ of weight k is reducible over \mathbb{Q} or $\dim(M_{wt(h)}) = \dim(M_{wt(g)})$.

Recall that the Eisenstein polynomial $\varphi_k(x)$ is monic with rational coefficients. See [7] or [15] for more information on this function.

Proof of Theorem 3.1.5. Suppose $h = fg$ where both f and h are Eisenstein series. Then $\varphi_{wt(f)}(x)$ divides $\varphi_{wt(h)}(x)$. Hence either $\varphi_{wt(f)}(x)$ is a constant, a constant multiple of $\varphi_{wt(h)}(x)$ or $\varphi_{wt(h)}(x)$ is reducible.

If $\varphi_{wt(f)}(x)$ is a constant, then f must be one of E_4, E_6, E_8, E_{10} , or E_{14} . Thus by comparing the roots of g and h , $\dim(M_{wt(h)}) = \dim(M_{wt(g)})$.

If $\varphi_{wt(f)}(x)$ is a constant multiple of $\varphi_{wt(h)}(x)$ then $\dim(M_{wt(f)}) = \dim(M_{wt(h)})$, and thus g must be one of E_4, E_6, E_8, E_{10} , or E_{14} . However, then f, g , and h are all Eisenstein series, which by [9] and [16] can only occur if $\dim(M_{wt(f)}) = \dim(M_{wt(g)}) = \dim(M_{wt(h)}) = 1$. \square

From the dimension formula [8] for spaces of modular forms we find that $\dim(M_{wt(h)}) = \dim(M_{wt(g)})$ occurs only in the following cases.

Lemma 3.4.1. *Write $h = fg$ where h and f are both Eisenstein series. Then $\dim(M_{wt(h)}) = \dim(M_{wt(g)})$ in only the following cases:*

$$wt(f) = 4, wt(g) \equiv 0, 4, 6, 10 \pmod{12},$$

$$wt(f) = 6, wt(g) \equiv 0, 4, 8 \pmod{12},$$

$$wt(f) = 8, wt(g) \equiv 0, 6 \pmod{12},$$

$$wt(f) = 10, wt(g) \equiv 0, 4 \pmod{12},$$

$$wt(f) = 14, wt(g) \equiv 0 \pmod{12},$$

On the other hand if $\dim(M_{wt(h)}) = \dim(M_{wt(g)})$, Lemma 3.4.1 implies that $wt(f)$ is one of 4, 6, 8, 10, or 14. Thus $\dim(M_{wt(f)}) = 1$. In these cases we can construct a factorization $h = fg$ as in the previous section. Again note that if $\dim(S_{wt(h)}) = 1$, then the above reduces to the cases that are treated in [9] and [16].

Corollary 3.4.2. *If $h = fg$ with h and f Eisenstein series and $\varphi_{wt(h)}(x)$ is irreducible over \mathbb{Q} , then f comes from a one dimensional space, i.e. $wt(f) = 4, 6, 8, 10, 14$.*

We note that while part of the hypothesis regarding $\varphi_{wt(h)}(x)$ used in the above corollary may appear strange, it is conjectured to always be the case [7, 15].

3.5 Relationship to L -values

In this section we investigate the relationship between the divisibility properties, discussed in Section 3.3 and Rankin Selberg L -values. As in (3.1.2) we write $h = fg$ to denote the eigenform f dividing the eigenform h . Here the dividend h is a cuspform, and the divisor $f = E_s$ is an Eisenstein series. Thus the quotient g is cuspidal. Let $\{h_1, \dots, h_d\}$ and $\{g_1, \dots, g_b\}$ be normalized eigenform bases for $S_{wt(h)}$ and $S_{wt(g)}$ respectively, where $d = \dim(S_{wt(h)})$ and $b = \dim(S_{wt(g)})$.

Write $g = \sum_{n \geq 1} a_n q^n$, and $h = \sum_{n \geq 1} b_n q^n$. The Rankin-Selberg convolution of $L(g, s)$ and $L(h, s)$ is defined by

$$L(g \times h, s) = \sum_{n \geq 1} \frac{a_n \overline{b_n}}{n^s}.$$

With this notation the Rankin-Selberg method [4] yields

$$\langle g, E_s h \rangle = (4\pi)^{-s+wt(g)-1} \Gamma(s+wt(g)-1) L(g \times h, s). \quad (3.5.1)$$

We are particularly interested in the Rankin-Selberg L -function value at $s = wt(h) - 1$, hence we use the following notation.

$$L(g, h) := L(g \times h, wt(h) - 1).$$

We will employ Theorem 3.1.4 to give insight into the question of linear independence of certain vectors of Rankin-Selberg L -values. Recall that eigenforms are orthogonal under the Petersson inner product ($\langle h_j, h_i \rangle = 0$ for $j \neq i$). Let $h_1 = h = E_r g$ and express g in terms of its eigenform bases, $g = c_1 g_1 + \dots + c_d g_d$. Then for each $i \neq 1$, we have,

$$c_1 \langle E_s g_1, h_i \rangle + \dots + c_b \langle E_s g_b, h_i \rangle = \langle h_1, h_i \rangle = 0.$$

Setting $s = wt(h) - 1$ and dividing by $(4\pi)^{-wt(h)-1} (wt(h) - 1)!$, (3.5.1) yields for each $i \neq 1$,

$$c_1 L(E_s g_1, h_i) + \dots + c_b L(E_s g_b, h_i) = 0. \quad (3.5.2)$$

We express the coefficients in 3.5.2 as a set of vectors,

$$\left\{ \begin{bmatrix} L(g_1, h_2) \\ \vdots \\ L(g_1, h_d) \end{bmatrix}, \dots, \begin{bmatrix} L(g_b, h_2) \\ \vdots \\ L(g_b, h_d) \end{bmatrix} \right\}. \quad (3.5.3)$$

Proposition 3.5.4. *Let $\{h_1, \dots, h_d\}$ and $\{g_1, \dots, g_b\}$ be normalized eigenform bases for the spaces $S_{wt(h)}$ and $S_{wt(g)}$ respectively, with $wt(h) \geq wt(g) + 4$. If there is an n such that $T_{n, wt(h)}(x)$ is irreducible over \mathbb{Q} and $d > b$, then the vectors of L values given in (3.5.3) are linearly independent over \mathbb{C} . If there is an n such that $T_{n, wt(h)}(x)$ is irreducible over \mathbb{Q} and $d = b$ there is precisely one dependence relation.*

Proposition 3.5.4 can be restated in terms of the matrix $M = M(g \times h)$ whose columns are the vectors in 3.5.3.

Proposition 3.5.4'. *Let $\{h_1, \dots, h_d\}$ and $\{g_1, \dots, g_b\}$ be normalized eigenform bases for the spaces $S_{wt(h)}$ and $S_{wt(g)}$ respectively, with $wt(h) \geq wt(g) + 4$. If there is an n such that $T_{n, wt(h)}(x)$ is irreducible over \mathbb{Q} , then the matrix $M(g \times h)$ is of full rank.*

Proof. Suppose $T_{n, wt(h)}(x)$ is irreducible for some n . There are two cases to consider.

Case 1: $d > b$. Suppose there is a solution $[c_1, \dots, c_b]^T$ to the matrix equation $M\vec{x} = \vec{0}$. We must show that $[c_1, \dots, c_b]^T = \vec{0}$. We have, for each $i = 2, 3, \dots, d$,

$$c_1 L(g_1, h_i) + \dots + c_b L(g_b, h_i) = 0.$$

By using the Rankin-Selberg method and denoting $G := c_1 g_1 + \dots + c_b g_b$, we have $\langle G \cdot E_s, h_i \rangle = 0$ for $i = 2, \dots, d$. Hence $G \cdot E_s$ is orthogonal to each of h_2, h_3, \dots, h_d and so $G \cdot E_s = c h_1$ for some $c \in \mathbb{C}$. Theorem 3.1.4 implies $G = 0$ and $c = 0$, which further implies that $c_1 = \dots = c_b = 0$.

Case 2: $d = b$. Because M is underdetermined there clearly are nonzero solutions to the matrix equation $M\vec{x} = \vec{0}$. We must show that M has nullity 1. Suppose there are two nonzero solutions $[c_1, \dots, c_b]^T$ and $[c'_1, \dots, c'_b]^T$ to the matrix equation $M\vec{x} = \vec{0}$. Similar to above we construct $G := c_1 g_1 + \dots + c_b g_b$ and $G' := c'_1 g_1 + \dots + c'_b g_b$ which satisfy, respectively, $E_s G = c h_1$, $E_s G' = c' h_1$ for some $c, c' \in \mathbb{C}$. Thus G and G' are scalar multiples of each other. Thus any two solutions are dependent.

□

3.6 Conclusions and Maeda's Conjecture

The main results of this chapter state that if there are eigenforms h and f and a modular form g such that $h = fg$ then either the modular spaces containing g and h must have the same dimension or all of the Hecke polynomials for $S_{wt(h)}$ or the Eisenstein polynomial of weight $wt(h)$ are reducible, depending on whether h is cuspidal or not. In this section we discuss the unlikeliness that these polynomials are reducible and we discuss the cases that the modular spaces containing g and h do in fact have the same dimension. First, we state the following partial converse of Theorems 3.1.3, 3.1.4 and, 3.1.5.

Proposition 3.6.1. *Let h and f be eigenforms.*

Case (1) Both h and f are cuspidal eigenforms. If $\dim(S_{wt(h)}) = \dim(M_{wt(h)-wt(f)})$, then there is a modular form g such that $fg = h$.

Case (2) Only h is a cuspidal eigenform, f is an Eisenstein series. If $\dim(S_{wt(h)}) = \dim(S_{wt(h)-wt(f)})$, then there is a cuspidal modular form g such that $fg = h$.

Case (3) Both h and f are Eisenstein series. If $\dim(M_{wt(h)}) = \dim(M_{wt(h)-wt(f)})$, then there is a modular form g such that $fg = h$.

In each of Cases 1, 2, and 3 there are infinitely many examples of eigenforms f and h such that f divides h as in Equation (3.1.2).

Proof. Here, we only consider one specific instance of Case 2. The other instances and cases follow similarly. From Lemma 3.3.1 we see that there are twelve infinite classes such as $wt(f) = 4$, $wt(h) \equiv 4$ modulo 12. In each of these instances we can divide any cuspidal eigenform h of weight $wt(h)$ by E_4 . This is because $\dim(S_{wt(g)}) = \dim(S_{wt(h)})$ and so $E_4 S_{wt(g)} = S_{wt(h)}$. □

Example 3.6.2. *We now present an explicit example of a factorization in which g is not an eigenform. Let $\{h_1, h_2\}$ be an eigenform basis for S_{28} . Note that $\{E_{16}\Delta, E_4\Delta^2\}$ is another, more explicit, basis. Hence we can write h_1 and h_2 in terms of these functions, one of which is*

$$E_{16}\Delta + \left(-\frac{14903892}{3617} - 108\sqrt{18209} \right) E_4\Delta^2.$$

Factoring E_4 out of the above form gives the following equation expressed in terms of the basis $\{E_{12}\Delta, \Delta^2\}$ of S_{24} ,

$$E_4 \left(E_{12}\Delta + \left(-\frac{3075516}{691} - 108\sqrt{18209} \right) \Delta^2 \right) = E_{16}\Delta + \left(-\frac{14903892}{3617} - 108\sqrt{18209} \right) E_4\Delta^2.$$

Note in particular that the quotient, $E_{12}\Delta + \left(-\frac{3075516}{691} - 108\sqrt{18209} \right) \Delta^2$, is not an eigenform and recall that $E_4 \cdot E_{12} \neq E_{16}$.

Call a factorization not counted by Proposition 3.6.1 *exceptional*; such a factorization would involve a quotient g and dividend h that come from modular spaces of different dimensions. In light of the following conjectures, we believe there are no exceptional factorizations. If this is true then Proposition 3.6.1 is a full converse of Theorems 3.1.3, 3.1.4, and 3.1.5.

Conjecture 3.6.3 (Maeda, [19]). *The Hecke algebra over \mathbb{Q} of $S_k(SL_2(\mathbb{Z}))$ is simple (that is, a single number field) whose Galois closure over \mathbb{Q} has Galois group isomorphic to the symmetric group \mathcal{S}_n (with $n = \dim S_k(SL_2(\mathbb{Z}))$).*

Maeda's conjecture significantly restricts the factorization of the Hecke polynomial $T_{n,k}(x)$. Proposition 3.6.4 below tells us that if $T_{n,k}(x)$ has full Galois group then $T_{n,k}(x)$ is irreducible over all fields \mathbb{F} with $[\mathbb{F} : \mathbb{Q}] < \dim(S_k)$. This is significant because \mathbb{F}_f used in Section 3.2 satisfies this condition.

This conjecture appeared in [19], and in the same paper was verified for weights less than 469. Buzzard [5] showed that $T_{2,k}(x)$ is irreducible up to weight 2000. The fact that $T_{p,k}(x)$ has full Galois group was verified for $p \leq 2000$ up to weight 2000 by Farmer and James [12]. Kleinerman [22] showed that $T_{2,k}(x)$ is irreducible up to weight 3000. Alhgren [1] showed for all weights k that if for some n , $T_{n,k}(x)$ is irreducible and has full Galois group, then $T_{p,k}(x)$ does as well for all $p \leq 4,000,000$. Finally from correspondence between Stein and Ghitza it is known that $T_{2,k}(x)$ is irreducible up to weight 4096. In particular for weights less than 2000 Case 1 in Proposition 3.6.1 is a full converse of Theorem 3.1.3, and for weights less than 4096 Case 2 in Proposition 3.6.1 is a full converse of Theorem 3.1.4.

Proposition 3.6.4. *Let $P(x) \in \mathbb{Q}[x]$ be a degree d polynomial. Let K_P be its splitting field. Assume $[K_P : \mathbb{Q}] = d!$. If P factors over K , then $[K : \mathbb{Q}] \geq d$.*

Proof. Suppose P is reducible over K and $[K : \mathbb{Q}] < d$. Write $P = QR$, where $Q, R \in K[x]$ are polynomials of degrees d_1, d_2 and have splitting fields K_Q, K_R respectively. Then $d_1 + d_2 = d$ and so

$$d_1!d_2! \geq [K_Q : K] \cdot [K_R : K] \geq [K_Q K_R : K] \geq [K_P : K] > (d-1)!,$$

which occurs if and only if $d_1 = 0$ or $d_2 = 0$. Hence one of Q or R is a constant, so that P is irreducible over K . \square

Concerning the Eisenstein polynomials, $\varphi_k(x)$, we have the following.

Conjecture 3.6.5 (Cornelissen [7] and Gekeler [15]). *The Eisenstein polynomials $\varphi_k(x)$ have full Galois group \mathcal{S}_n (with $n = \dim(S_k)$), in particular they are irreducible over \mathbb{Q} .*

This question was first raised by Cornelissen [7] and Gekeler [15], who found that $\varphi_k(x)$ has full Galois group for all weights $k \leq 172$. We have verified the irreducibility of $\varphi_k(x)$ for weights up to 2500.

We computed $\varphi_k(x)$ modulo small primes p for weights through 2500 to verify that it is irreducible. An equation presented in [21] and [7] gives the equation

$$\frac{E_k}{E_4^a E_6^b \Delta^c} = \varphi_k(j(\tau)),$$

where $4a + 6b + 12c = r$, with $0 \leq a \leq 2$, $0 \leq b \leq 1$. For each weight computed there is a small prime p such that $\varphi_k(x)$ is indeed irreducible modulo p , and so $\varphi_k(x)$ is irreducible over \mathbb{Q} . There is no reason other than runtime that the highest weight computed was 2500. In these weights Case 3 of Proposition 3.6.1 is a full converse of Theorem 3.1.5.

As a final remark we note that if conjectures 3.6.4 and 3.6.5 are true, then Proposition 3.6.1 is a full converse to all the main theorems. This means that an eigenform is divisible by another eigenform precisely in the cases listed in Lemmas 3.2.5, 3.3.1, and 3.4.1.

Chapter 4

Computations

4.1 Computing Examples

There were several examples computed that required the use of computer software, such as Example 3.6.2.

These examples were computed in Maple using the basic properties of linear algebra and q -expansions. In particular the first part of the q -expansions of the modular forms are computed. Only the first $\dim(M_k)$ coefficients are needed to fully determine the modular form of weight k . However, because M_k is a complex vector space we can treat these coefficients as vectors and merely use linear algebra to solve for an example of the desired weight.

4.2 Computing $\varphi_k(x)$

The following is my approach with Maple to compute $\varphi_k(x) = \prod(x - j_i)$, where the product runs over all the j -zeros of E_k except for 0 and 1728. (Under the j mapping i and ρ correspond to 0 and 1728). Note that $\varphi_k(x)$ is monic with rational coefficients. See [15] for more information on this function.

Our computation will use an equation presented in [21] which gives an equality for $f(j(\tau)) = \varphi_k(\tau)$:

$$\frac{E_k}{E_4^a E_6^b \Delta^c} = f(j(\tau))$$

where $4a + 6b + 12c = r$, and $0 \leq a \leq 2, 0 \leq b \leq 1$.

In theory we can just compute Fourier expansions of E_k, E_4, E_6 , and Δ , then compute $f(\tau)$. In practice this computation is somewhat nontrivial. This is because computing the right hand side involves computing the symbolic polynomial $f(j(\tau))$. My approach involved computing all required powers of j and combining like terms. However, even with small coefficients and truncated series, this still involves $\Omega(n^3)$ computations.

4.3 Basic Idea

1. Given the highest weight $\max(k)$ we will compute, find and store $\frac{\Delta}{q}, \left(\frac{\Delta}{q}\right)^2, \dots, \left(\frac{\Delta}{q}\right)^{\max(k)/12+1}$.

Note that $\frac{\Delta}{q}$ is found by expanding $\prod_{k=1}^{\max(k)/12+1} (1 - x^k)^{24}$. Powers are then found iteratively by multiplying by $\frac{\Delta}{q}$.

2. Initialize an array to keep track of which weights we have found $\varphi_k(x)$ to be irreducible.
3. Loop over primes p :

(a) Compute $E_k \pmod p$ for all unfinished weights k up to $\max(k)$.

(b) Loop even weights from 16 to $\max(k)$:

- i. Check to see if the prime is a bad prime for this weight, if so skip this weight. By bad prime I mean if $\gcd(n(B_k)d(B_k)d(B_4)d(B_6), k) \neq 1$ where d denotes denominator and n denotes numerator. One could be more careful here, but it is not necessary to be more careful.
- ii. Compute the dimension of large space, that is the number of coefficients we will need to compute to find f ; $\dim = 1 + \lfloor \frac{k-3}{12} \rfloor + 1 - \lceil \frac{k \pmod{12}}{12} \rceil$.
- iii. Compute the LHS: this is all done as power series at first. The actual computation finds (mod p) the coefficients of $\frac{1}{q^c}, \dots, q^0$ in:

$$\frac{1}{q^c} \cdot \frac{E_k}{\left(\frac{\Delta}{q}\right)^c}.$$

- iv. Compute the RHS: Construct a generic $f(x) = \sum_{i=0}^c a_i x^i$ and evaluate it at $x = j(q)$ mod p , storing only the coefficients of $\frac{1}{q^c}, \dots, q^0$.

- j is computed mod p , using only the coefficients of $\frac{1}{q}, \dots, q^c$.
- j^i is computed iteratively from j^{i-1} , via

$$\left[\frac{1}{q^c}, \dots, q^c \right] j^{i-1} := \left[\frac{1}{q^c}, \dots, q^c \right] \left(j^{i-1} \cdot \left[\frac{1}{q}, \dots, q^c \right] j \right)$$

where the notation $[b_1, \dots, b_n]g$ denotes g truncated to only keep the terms involving b_1, \dots, b_n .

- v. Find the coefficients a_i in the right hand side. We already have the LHS and RHS. Solve for a_{c-1} by using the linear equation formed by $\left[\frac{1}{q^{c-1}} \right] LHS = \left[\frac{1}{q^{c-1}} \right] RHS$. Then iteratively solve for a_{c-i} from $\left[\frac{1}{q^{c-i}} \right] LHS = \left[\frac{1}{q^{c-i}} \right] RHS$ where i ranges from 1 to c .
- vi. Construct the function $f(x)$ using the above coefficients, and check if it is irreducible modulo p . If it is, then set that it is completed, and store k, p , and f .

4. Verification: As a sanity check to make sure the algorithm is not obviously bugged, I took one of the resulting functions, $f = 23 + 25 * x + 22 * x^2 + x^3 + 10 * x^4 + 27 * x^5 + 29 * x^6 + x^7 + x^8$ for $k = 100$ and $p = 37$ and evaluated the LHS and RHS to 200 coefficients and checked that $\left[\frac{1}{q^8}, \dots, q^{200} \right] (LHS - RHS) = 0$.

Chapter 5

Future Directions

There are many questions related to the topics of this thesis that have future potential. This chapter provides some detail on these future directions.

5.1 The Rankin-Cohen Bracket Operator

Lanphier and Takloo-Bighash [26] showed that the Rankin-Cohen Bracket of two eigenforms is only an eigenform when forced to be by dimension considerations. One can also consider the question of divisibility in this situation. That is, we can ask a similar question as in Chapter 3. In particular, if f and h are eigenforms and n is a nonnegative integer, when is there a modular form g such that $[f, g]_n = h$?

Investigating the above problem will likely lead one to ask when the Rankin-Cohen bracket operator is injective. Hence another question I am interested in pursuing is characterizing for what f, g , and n does $[f, g]_n = 0$.

This question is surprisingly nontrivial. It would appear from computations that $[f, g]_n$ is usually injective. However, there are some cases that it is clearly not. This is due to a zero, such as for instance the following:

1. $[\Delta^a, \Delta^b]_1 = 0$
2. $[E_4\Delta, E_8\Delta^2]_1 = 0$
3. $[E_4\Delta^2, E_8\Delta^4]_1 = 0, [E_4\Delta^3, E_8\Delta^6]_1 = 0, [E_4\Delta^4, E_8\Delta^8]_1 = 0, \dots$

$$4. [E_6\Delta^2, E_4\Delta^{10}]_2 = 0, [E_6\Delta^3, \Delta^{25}]_2 = 0, [E_{10}\Delta^9, \Delta^{585}]_2 = 0.$$

$$5. [E_4, aE_{12} + b\Delta]_5 = 0, \dots, [E_8, aE_{16} + bE_4\Delta]_1 = 0 \text{ for the appropriate choices of } a, b \in \mathbb{R}.$$

It is not at all clear what pattern (4) above follows. These computations (3,4) were from an exhaustive search of the brackets $[f, g]_n$ such that $\dim(S_{wt(f)+wt(g)+2n}) = \dim(S_{wt(f)}) + \dim(S_{wt(g)})$, with $wt(f) < 5000$, $wt(g) < 10000$, $0 < n < 8$. No example with $n > 2$ was found, and only three cases with $n = 2$ were found. It would appear that all cases with $n = 1$ satisfy $2wt(f) = wt(g)$, or $wt(f) = wt(g)$ (if $f = g$ and n is odd the bracket is trivially not injective).

In all other cases it was found that the coefficient is nonzero, and so $[f, S_{wt(g)}]_n, [S_{wt(f)}, g]_n$ are necessarily injective (The coefficient calculated is $[q^{wt(f)+wt(g)}][f, g]_n$).

5.2 Nearly Holomorphic Modular Forms

We showed in Chapter 2 exactly when the product of two nearly holomorphic eigenforms is again an eigenform. However, what if we allow a third factor of an eigenform, or more? It would be interesting to see if the product of many nearly holomorphic eigenforms can nontrivially be an eigenform.

This question actually relates to Rankin-Cohen bracket operators. In particular recall from Chapter 2 that a product of nearly holomorphic modular forms can be expressed in terms of a sum of Rankin-Cohen bracket operators. In that chapter we used a result regarding the Rankin-Cohen bracket of two eigenforms. However, when one considers the product of many nearly holomorphic eigenforms, the Rankin-Cohen bracket of an eigenform and a modular form arises. Hence we want to know when this function is an eigenform. In the previous section we noted that there are Rankin-Cohen brackets which are injective. The cases that the dimension of the space of the operand and output are the same lead to cases that $[f, g]_n$ is an eigenform, so there might be nontrivial cases that the product of many nearly holomorphic eigenforms is an eigenform, although this would be surprising.

5.3 Properties of $\varphi_k(x)$

In Chapter 3 we used a polynomial $\varphi_k(x)$, which we called the Eisenstein polynomial of weight k . In Chapter 4 we mention our computations of this polynomial modulo various primes.

In that section our aim was to determine the irreducibility of $\varphi_k(x)$. In these computations several curious properties arose, which I would like to investigate why these exist and if they hold true in general. In particular it would appear that:

1. $\varphi_k(x)$ is always reducible modulo 11, 17, 23, and 29.
2. $\varphi_k(x)$ and $\varphi_l(x)$ while different for $k \neq l$, often have the same reduction modulo small primes, if k and l are close. But not always. For instance modulo 11, $\varphi_{1764}(x) \not\equiv \varphi_{1772}(x)$, however $\varphi_{1538}(x) \equiv \varphi_{1544}(x)$. These examples were taken because they both compare weights congruent to 0 and 8 modulo 12.
3. Sometimes $\varphi_k(x) \equiv x * \varphi_{k-2}(x)$ modulo p , but not most of the time.

5.4 Add level

The obvious, albeit difficult, next step would be to add level. That is, ask when the product of eigenforms for level N is again an eigenform. This question has been asked by several people, and some progress has been made toward an answer, all for various specific classes of congruence subgroups. In particular Ghate [17] investigated this for level $\Gamma_1(N)$, N square free, Emmons [10] investigated this for $\Gamma_0(p)$ where p is prime, and Johnson [20] investigated this for level $\Gamma_1(N)$. It would be interesting to see if this can be extended to a more general level. Of course there are nuances to take care of, such as, for instance the fact that one must modify the definition of an eigenform to coincide with the properties of Hecke operators in higher level.

5.5 The general question

One could generalize all of this to a single question: what does it take to have closure of eigenforms under an operator? Consider a graded algebra $\oplus M_k$ wherein multiplication of elements results in addition of their weights. And suppose there is a set of linear operators on each space, $\{T_{n,k}\}_{n,k}$. Call an eigenform of weight k an element which is an eigenvector for all $\{T_{n,k}\}_n$. What conditions are necessary to have the property that eigenforms are closed under multiplication? That is, if f and g are eigenforms, that $f \cdot g$ must be as well.

5.6 More computations

There are several things that I would like to continue computationally.

Regarding $T_{n,k}(x)$ one could check for irreducibility or for full Galois group. Regarding irreducibility, $T_{2,k}(x)$ has been verified to be irreducible up through weights 4096, although this was done by actually computing $T_{2,k}(x)$. Hence a computation modulo p should almost trivially push that further. On the other hand finding full Galois group will also allow Alghren's result to apply, and has only been found up through weight 2000.

As for $\varphi_k(x)$ I think I have my algorithm nearly as efficient as possible (without using advanced multiplication techniques such as FFT), so to push this further would mean merely using more computational resources (it is very easily parallelizable). However, I prefer algorithm design and don't see much point in merely using more computational power when such will change in a few years anyway.

Lastly there is the Rankin-Cohen bracket operator. I did some fairly large searches to find brackets which were not injective. There are also some peculiarities that occurred regarding when there are zeros. While this topic is beyond the scope of this thesis, I do plan on continuing to figure out what is going on with these bracket operators. This will likely include many computations related to them.

Bibliography

- [1] Scott Ahlgren. On the irreducibility of Hecke polynomials. *Math. Comp.*, 77(263):1725–1731, 2008.
- [2] Tom M. Apostol. *Introduction to analytic number theory*. Springer-Verlag, New York, 1976. Undergraduate Texts in Mathematics.
- [3] Jeffrey Beyerl, Kevin James, Catherine Trentacoste, and Hui Xue. Products of nearly holomorphic eigenforms. *The Ramanujan Journal*, 27(3):377–386, 2012.
- [4] Daniel Bump. The Rankin-Selberg method: a survey. In *Number theory, trace formulas and discrete groups (Oslo, 1987)*, pages 49–109. Academic Press, Boston, MA, 1989.
- [5] Kevin Buzzard. On the eigenvalues of the Hecke operator T_2 . *J. Number Theory*, 57(1):130–132, 1996.
- [6] John B. Conway. *Functions of one complex variable*, volume 11 of *Graduate Texts in Mathematics*. Springer-Verlag, New York, second edition, 1978.
- [7] Gunther Cornelissen. Zeros of Eisenstein series, quadratic class numbers and supersingularity for rational function fields. *Math. Ann.*, 314(1):175–196, 1999.
- [8] Fred Diamond and Jerry Shurman. *A first course in modular forms*, volume 228 of *Graduate Texts in Mathematics*. Springer-Verlag, New York, 2005.
- [9] W. Duke. When is the product of two Hecke eigenforms an eigenform? In *Number theory in progress, Vol. 2 (Zakopane-Kościelisko, 1997)*, pages 737–741. de Gruyter, Berlin, 1999.
- [10] Brad A. Emmons. Products of Hecke eigenforms. *J. Number Theory*, 115(2):381–393, 2005.
- [11] Brad A. Emmons and Dominic Lanphier. Products of an arbitrary number of Hecke eigenforms. *Acta Arith.*, 130(4):311–319, 2007.
- [12] D. W. Farmer and K. James. The irreducibility of some level 1 Hecke polynomials. *Math. Comp.*, 71(239):1263–1270 (electronic), 2002.
- [13] Paul Garrett. Basic rankin-selberg. http://www.math.umn.edu/~garrett/m/v/basic_rankin_selberg.pdf, 2010.
- [14] Ernst-Ulrich Gekeler. Some observations on the arithmetic of Eisenstein series for the modular group $SL(2, \mathbb{Z})$. *Arch. Math. (Basel)*, 77(1):5–21, 2001. Festschrift: Erich Lamprecht.
- [15] Ernst-Ulrich Gekeler. Some observations on the arithmetic of Eisenstein series for the modular group $SL(2, \mathbb{Z})$. *Arch. Math. (Basel)*, 77(1):5–21, 2001. Festschrift: Erich Lamprecht.
- [16] Eknath Ghate. On monomial relations between Eisenstein series. *J. Ramanujan Math. Soc.*, 15(2):71–79, 2000.

- [17] Eknath Ghate. On products of eigenforms. *Acta Arith.*, 102(1):27–44, 2002.
- [18] Alex Ghitza. Correspondence. http://wstein.org/Tables/charpoly_level1/t2/ghitza.html, 2010.
- [19] Haruzo Hida and Yoshitaka Maeda. Non-abelian base change for totally real fields. *Pacific J. Math.*, (Special Issue):189–217, 1997. Olga Taussky-Todd: in memoriam.
- [20] Matthew Johnson. Hecke eigenforms as products of eigenforms. <http://arxiv.org/abs/1110.6430>, 2011.
- [21] M. Kaneko and D. Zagier. Supersingular j -invariants, hypergeometric series, and Atkin’s orthogonal polynomials. In *Computational perspectives on number theory (Chicago, IL, 1995)*, volume 7 of *AMS/IP Stud. Adv. Math.*, pages 97–126. Amer. Math. Soc., Providence, RI, 1998.
- [22] Seth Kleinerman. Some computations in support of maeda’s conjecture. http://modular.math.washington.edu/edu/Fall2003/252/final_project/seth/252paper.pdf, 2010.
- [23] Neal Koblitz. *Introduction to Elliptic Curves and Modular forms*. Springer, 1993.
- [24] Serge Lang. *Introduction to modular forms*, volume 222 of *Grundlehren der Mathematischen Wissenschaften [Fundamental Principles of Mathematical Sciences]*. Springer-Verlag, Berlin, 1995. With appendixes by D. Zagier and Walter Feit, Corrected reprint of the 1976 original.
- [25] Dominic Lanphier. Combinatorics of Maass-Shimura operators. *J. Number Theory*, 128(8):2467–2487, 2008.
- [26] Dominic Lanphier and Ramin Takloo-Bighash. On Rankin-Cohen brackets of eigenforms. *J. Ramanujan Math. Soc.*, 19(4):253–259, 2004.
- [27] Toshitsune Miyake. *Modular forms*. Springer-Verlag, Berlin, 1989. Translated from the Japanese by Yoshitaka Maeda.
- [28] Hiroshi Nozaki. A separation property of the zeros of Eisenstein series for $SL(2, \mathbb{Z})$. *Bull. Lond. Math. Soc.*, 40(1):26–36, 2008.
- [29] F. K. C. Rankin and H. P. F. Swinnerton-Dyer. On the zeros of Eisenstein series. *Bull. London Math. Soc.*, 2:169–170, 1970.
- [30] R. A. Rankin. Elementary proofs of relations between Eisenstein series. *Proc. Roy. Soc. Edinburgh Sect. A*, 76(2):107–117, 1976/77.
- [31] Goro Shimura. The special values of the zeta functions associated with cusp forms. *Comm. Pure Appl. Math.*, 29(6):783–804, 1976.
- [32] Goro Shimura. *Introduction to the arithmetic theory of automorphic functions*, volume 11 of *Publications of the Mathematical Society of Japan*. Princeton University Press, Princeton, NJ, 1994. Reprint of the 1971 original, Kanô Memorial Lectures, 1.
- [33] Goro Shimura. *Elementary Dirichlet series and modular forms*. Springer Monographs in Mathematics. Springer, New York, 2007.
- [34] D. Zagier. Modular forms whose Fourier coefficients involve zeta-functions of quadratic fields. In *Modular functions of one variable, VI (Proc. Second Internat. Conf., Univ. Bonn, Bonn, 1976)*, pages 105–169. Lecture Notes in Math., Vol. 627. Springer, Berlin, 1977.

Index

- \mathbb{F}_f , 17
- q -expansion, 3
- B_k , 4
- L -function, 9
- L -value, 10
- M_k , 3
- $SL_2(\mathbb{Z}) \backslash \mathbb{H}$, 1
- S_k , 3
- $\Delta(z)$, 4
- Γ , 1
- $\Gamma \backslash \mathbb{H}$, 1
- $\delta_k^{(r)}(f)$, 19
- δ_k , 18
- $\sigma_{k-1}(n)$, 4
- $\varphi_k(x)$, 7
- j -function, 4, 7
- j -invariant, 4
- j -zeros, 9
- Eisenstein polynomial, 7
- Eisenstein series, 4
- Euler product, 13
- Galois, 16
- Galois group of a polynomial, 16
- Hecke Algebra, 13
- Hecke Operator, 12
- Hecke Polynomial, 13
- Hecke operator
 - Nearly holomorphic, 19
- Möbius transformation, 2
- Maass-Shimura Operator, 18
- Maeda's Conjecture, 15
- Petersson inner product, 14
- Rankin-Cohen bracket operator, 17
- Rankin-Selberg Convolution, 14
- Action
 - $SL_2(\mathbb{Z})$ on \mathbb{H} , 2
- Basis of M_k
 - Diagonal, 6
- Cuspidal modular form, 3
- Derivative, 17
- Diagonal basis, 6
- Dimension, 5
- Eigenform, 13
- Fractional linear transformation, 2
- Fundamental domain, 2
- Growth rate
 - Modular form, 3
- Level
 - Full, 1
- Modular form, 3
- Modular function, 3
- Nearly holomorphic modular forms, 18
- Self-adjoint
 - Hecke Operator, 14
- Upper half plane, 1
- Weight
 - Holomorphic, 18
 - Non-holomorphic, 18
- Eigenform
 - Normalized, 13
- Modular Form
 - Zeros, 7
- Modular Function, 3
- Order of vanishing, 7
- Root of unity, 7
- Valence Formula, 7